



GRANT AGREEMENT

NUMBER — 737483 — WInSiC4AP

This **Agreement** ('the Agreement') is **between** the following parties:

on the one part,

the **Electronic Component Systems for European Leadership Joint Undertaking** ('the JU'),

represented for the purposes of signature of this Agreement by the Executive Director or his/her representative, Bert DE COLVENAER,

and

on the other part,

1. 'the coordinator':

DISTRETTO TECNOLOGICO SICILIA MICROE NANO SISTEMI SCARL (DTSMNS) SCARL, 308056, established in ZONA INDUSTRIALE VIII STRADA SN, CATANIA 95121, Italy, IT04620770877 represented for the purposes of signing the Agreement by PLSIGN, Filippo D'ARPA

and the following other beneficiaries, if they sign their 'Accession Form' (see Annex 3 and Article 56):

2. **STMICROELECTRONICS SRL (ST-I) SRL**, 09291380153, established in VIA C.OLIVETTI 2, AGRATE BRIANZA 20864, Italy, IT00951900968

3. **UNIVERSITA DEGLI STUDI DI CATANIA (UNICT)**, CF02772010878, established in PIAZZA UNIVERSITA 2, CATANIA 95131, Italy, IT02772010878

4. **NEXTER ELECTRONICS (NEXTER) FR39**, 439568700, established in 13 ROUTE DE LA MINIERE, VERSAILLES 78034, France, FR36439568700

5. **VALEO SYSTEMES DE CONTROLE MOTEUR SAS (VSCM) SAS**, 479162695, established in Avenue des Beguines 14, Cergy 95800, France, FR89479162695

6. **CONSORZIO NAZIONALE INTERUNIVERSITARIO PER LA NANOELETTRONICA (IUNET) IT4**, 452102/CF91253790371, established in VIA TOFFANO 2, BOLOGNA 40125, Italy, IT02598581201

7. **UNIVERSITA DEGLI STUDI DI MESSINA (UNIME)**, not applicable, established in PIAZZA PUGLIATTI 1, MESSINA 98122, Italy, IT00724160833

8. **CESKE VYSOKE UCENI TECHNICKE V PRAZE (UNIPRA)**, 68407700, established in ZIKOVA 4, PRAHA 16636, Czech Republic, CZ68407700
9. **GOTTFRIED WILHELM LEIBNIZ UNIVERSITAET HANNOVER (LUH)**, established in Welfengarten 1, HANNOVER 30167, Germany, DE811245527
10. **CONSIGLIO NAZIONALE DELLE RICERCHE (CNR)**, 80054330586, established in PIAZZALE ALDO MORO 7, ROMA 00185, Italy, IT02118311006
11. **ZODIAC AERO ELECTRIC SAS (ZODAERO) SAS**, 775694995, established in RUE DES LONGS QUARTIERS 7, MONTREUIL 93100, France, FR95775694995
12. **APOJEE (APOJEE) SAS**, 424963213, established in RUE GEORGES BESSE 29, CLERMOND FERRAND 63100, France, FR27424963213
13. **APSI3D (APSI) SAS**, 792492746, established in 67 BOULEVARD PIERRE RENAUDET, TARBES 65000, France, FR05792492746
14. **S.A.T.SICILIANA ARTICOLI TECNICI SRL (SAT) SRL**, 167876, established in VIA ALFREDO AGOSTA 31-33-35, CATANIA 95121, Italy, IT02390350870
15. **WURTH ELEKTRONIK EISOS GMBH & CO KG (WÜRTH) KG**, HRA580801, established in MAX EYTH STRASSE 1, WALDENBURG 74638, Germany, DE220618976
16. **UNIVERSITE FRANCOIS RABELAIS DE TOURS (UNITOU)**, 193708005, established in RUE DU PLAT D ETAIN 60, TOURS 37020, France, FR34193708005
17. **INSTITUT MIKROELEKTRONICKYCH APLIKACI S.R.O. (IMA) SRO**, 45277397, established in NA VALENTINCE 1003/1, PRAHA 5 - SMICHOV 150 00 , Czech Republic, CZ45277397
18. **E-DISTRIBUZIONE SPA (ED) SPA**, 922436, established in VIA OMBRONE 2, ROMA 00198, Italy, IT05779711000
19. **SOFTECO SISMAT SRL (SOFT) SRL**, 282329/CF02581250103, established in VIA DE MARINI 1, GENOVA 16149, Italy, IT02581250103
20. **DISTRETTO TECNOLOGICO AEROSPAZIALE DELLA CAMPANIA SCARL (DAC) SCARL**, 274405CF03807450618, established in VIA MAIORISE, CAPUA 81043, Italy, IT03807450618

Unless otherwise specified, references to ‘beneficiary’ or ‘beneficiaries’ include the coordinator.

The parties referred to above have agreed to enter into the Agreement under the terms and conditions below.

By signing the Agreement or the Accession Form , the beneficiaries accept the grant and agree to implement it under their own responsibility and in accordance with the Agreement, with all the obligations and conditions it sets out.

The Agreement is composed of:

Terms and Conditions

- Annex 1 Description of the action
- Annex 2 Estimated budget for the action
- Annex 3 Accession Forms
- Annex 4 Model for the financial statements
- Annex 5 Model for the certificate on the financial statements (CFS)
- Annex 6 Model for the certificate on the methodology

TERMS AND CONDITIONS

TABLE OF CONTENTS

CHAPTER 1 GENERAL.....	12
ARTICLE 1 — SUBJECT OF THE AGREEMENT.....	12
CHAPTER 2 ACTION.....	12
ARTICLE 2 — ACTION TO BE IMPLEMENTED.....	12
ARTICLE 3 — DURATION AND STARTING DATE OF THE ACTION.....	12
ARTICLE 4 — ESTIMATED BUDGET AND BUDGET TRANSFERS.....	12
4.1 Estimated budget.....	12
4.2 Budget transfers.....	12
CHAPTER 3 GRANT.....	12
ARTICLE 5 — GRANT AMOUNT, FORM OF GRANT, REIMBURSEMENT RATES AND FORMS OF COSTS.....	12
5.1 Maximum grant amount.....	12
5.2 Form of grant, reimbursement rates and forms of costs.....	13
5.3 Final grant amount — Calculation.....	13
5.4 Revised final grant amount — Calculation.....	15
ARTICLE 6 — ELIGIBLE AND INELIGIBLE COSTS.....	15
6.1 General conditions for costs to be eligible.....	15
6.2 Specific conditions for costs to be eligible.....	16
6.3 Conditions for costs of linked third parties to be eligible.....	22
6.4 Conditions for in-kind contributions provided by third parties free of charge to be eligible.....	22
6.5 Ineligible costs.....	22
6.6 Consequences of declaration of ineligible costs.....	23
CHAPTER 4 RIGHTS AND OBLIGATIONS OF THE PARTIES.....	23
SECTION 1 RIGHTS AND OBLIGATIONS RELATED TO IMPLEMENTING THE ACTION.....	23
ARTICLE 7 — GENERAL OBLIGATION TO PROPERLY IMPLEMENT THE ACTION.....	23
7.1 General obligation to properly implement the action.....	23
7.2 Consequences of non-compliance.....	23

ARTICLE 8 — RESOURCES TO IMPLEMENT THE ACTION — THIRD PARTIES INVOLVED IN THE ACTION..... 23

ARTICLE 9 — IMPLEMENTATION OF ACTION TASKS BY BENEFICIARIES NOT RECEIVING JU FUNDING.....24

ARTICLE 10 — PURCHASE OF GOODS, WORKS OR SERVICES..... 24

 10.1 Rules for purchasing goods, works or services..... 24

 10.2 Consequences of non-compliance..... 24

ARTICLE 11 — USE OF IN-KIND CONTRIBUTIONS PROVIDED BY THIRD PARTIES AGAINST PAYMENT.....24

 11.1 Rules for the use of in-kind contributions against payment..... 24

 11.2 Consequences of non-compliance..... 25

ARTICLE 12 — USE OF IN-KIND CONTRIBUTIONS PROVIDED BY THIRD PARTIES FREE OF CHARGE..... 25

 12.1 Rules for the use of in-kind contributions free of charge.....25

 12.2 Consequences of non-compliance..... 25

ARTICLE 13 — IMPLEMENTATION OF ACTION TASKS BY SUBCONTRACTORS.....26

 13.1 Rules for subcontracting action tasks..... 26

 13.2 Consequences of non-compliance..... 26

ARTICLE 14 — IMPLEMENTATION OF ACTION TASKS BY LINKED THIRD PARTIES..... 26

 14.1 *Rules for calling upon linked third parties to implement part of the action..... 27*

 14.2 *Consequences of non-compliance..... 27*

ARTICLE 15 — FINANCIAL SUPPORT TO THIRD PARTIES..... 28

 15.1 Rules for providing financial support to third parties..... 28

 15.2 Financial support in the form of prizes..... 28

 15.3 Consequences of non-compliance..... 28

ARTICLE 16 — PROVISION OF TRANS-NATIONAL OR VIRTUAL ACCESS TO RESEARCH INFRASTRUCTURE..... 28

 16.1 Rules for providing trans-national access to research infrastructure..... 28

 16.2 Rules for providing virtual access to research infrastructure..... 28

 16.3 Consequences of non-compliance..... 28

SECTION 2 RIGHTS AND OBLIGATIONS RELATED TO THE GRANT ADMINISTRATION..... 28

ARTICLE 17 – GENERAL OBLIGATION TO INFORM.....28

 17.1 General obligation to provide information upon request.....28

 17.2 Obligation to keep information up to date and to inform about events and circumstances likely to affect the Agreement.....28

 17.3 Consequences of non-compliance..... 29

ARTICLE 18 — KEEPING RECORDS — SUPPORTING DOCUMENTATION.....	29
18.1 Obligation to keep records and other supporting documentation.....	29
18.2 Consequences of non-compliance.....	30
ARTICLE 19 — SUBMISSION OF DELIVERABLES.....	30
19.1 Obligation to submit deliverables.....	31
19.2 Consequences of non-compliance.....	31
ARTICLE 20 — REPORTING — PAYMENT REQUESTS.....	31
20.1 Obligation to submit reports.....	31
20.2 Reporting periods.....	31
20.3 Periodic reports — Requests for interim payments.....	31
20.4 Final report — Request for payment of the balance.....	32
20.5 Information on cumulative expenditure incurred.....	33
20.6 Currency for financial statements and conversion into euro.....	33
20.7 Language of reports.....	33
20.8 Consequences of non-compliance — Suspension of the payment deadline — Termination.....	33
ARTICLE 21 — PAYMENTS AND PAYMENT ARRANGEMENTS.....	34
21.1 Payments to be made.....	34
21.2 Pre-financing payment — Amount — Amount retained for the Guarantee Fund.....	34
21.3 Interim payments — Amount — Calculation.....	34
21.4 Payment of the balance — Amount — Calculation — Release of the amount retained for the Guarantee Fund.....	35
21.5 Notification of amounts due.....	36
21.6 Currency for payments.....	36
21.7 Payments to the coordinator — Distribution to the beneficiaries.....	36
21.8 Bank account for payments.....	36
21.9 Costs of payment transfers.....	36
21.10 Date of payment.....	37
21.11 Consequences of non-compliance.....	37
ARTICLE 22 — CHECKS, REVIEWS, AUDITS AND INVESTIGATIONS — EXTENSION OF FINDINGS.....	37
22.1 Checks, reviews and audits by the Commission and the JU.....	37
22.2 Investigations by the European Anti-Fraud Office (OLAF).....	39
22.3 Checks and audits by the European Court of Auditors (ECA).....	39
22.4 Checks, reviews, audits and investigations for international organisations.....	40
22.5 Consequences of findings in checks, reviews, audits and investigations — Extension of findings.....	40

22.6 Consequences of non-compliance.....	41
ARTICLE 23 — EVALUATION OF THE IMPACT OF THE ACTION.....	42
23.1 Right to evaluate the impact of the action.....	42
23.2 Consequences of non-compliance.....	42
SECTION 3 RIGHTS AND OBLIGATIONS RELATED TO BACKGROUND AND RESULTS.....	42
SUBSECTION 1 GENERAL.....	42
ARTICLE 23a — MANAGEMENT OF INTELLECTUAL PROPERTY.....	42
23a.1 Obligation to take measures to implement the Commission Recommendation on the management of intellectual property in knowledge transfer activities.....	42
23a.2 Consequences of non-compliance.....	42
SUBSECTION 2 RIGHTS AND OBLIGATIONS RELATED TO BACKGROUND.....	42
ARTICLE 24 — AGREEMENT ON BACKGROUND.....	43
24.1 Agreement on background.....	43
24.2 Consequences of non-compliance.....	43
ARTICLE 25 — ACCESS RIGHTS TO BACKGROUND.....	43
25.1 Exercise of access rights — Waiving of access rights — No sub-licensing.....	43
25.2 Access rights for other beneficiaries, for implementing their own tasks under the action.....	43
25.3 Access rights for other beneficiaries, for exploiting their own results.....	43
25.4 Access rights for affiliated entities.....	44
25.5 Access rights for third parties.....	44
25.6 Consequences of non-compliance.....	44
SUBSECTION 3 RIGHTS AND OBLIGATIONS RELATED TO RESULTS.....	44
ARTICLE 26 — OWNERSHIP OF RESULTS.....	44
26.1 Ownership by the beneficiary that generates the results.....	44
26.2 Joint ownership by several beneficiaries.....	45
26.3 Rights of third parties (including personnel).....	45
26.4 The JU ownership, to protect results.....	45
26.5 Consequences of non-compliance.....	46
ARTICLE 27 — PROTECTION OF RESULTS — VISIBILITY OF SUPPORT.....	46
27.1 Obligation to protect the results.....	46
27.2 The JU ownership, to protect the results.....	47
27.3 Information on funding from the JU and support from the EU and JU members.....	47
27.4 Consequences of non-compliance.....	47
ARTICLE 28 — EXPLOITATION OF RESULTS.....	47
28.1 Obligation to exploit the results.....	47

28.2 Results that could contribute to European or international standards — Information on funding from the JU and support from the EU and JU members.....	47
28.3 Consequences of non-compliance.....	48
ARTICLE 29 — DISSEMINATION OF RESULTS — OPEN ACCESS — VISIBILITY OF SUPPORT.....	48
29.1 Obligation to disseminate results.....	48
29.2 Open access to scientific publications.....	48
29.3 Open access to research data.....	49
29.4 Information on funding from the JU and support from the EU and JU members — Obligation and right to use the JU logo and the EU emblem.....	49
29.5 Disclaimer excluding JU responsibility.....	49
29.6 Consequences of non-compliance.....	50
ARTICLE 30 — TRANSFER AND LICENSING OF RESULTS.....	50
30.1 Transfer of ownership.....	50
30.2 Granting licenses.....	50
30.3 The JU right to object to transfers or licensing.....	50
30.4 Consequences of non-compliance.....	50
ARTICLE 31 — ACCESS RIGHTS TO RESULTS.....	51
31.1 Exercise of access rights — Waiving of access rights — No sub-licensing.....	51
31.2 Access rights for other beneficiaries, for implementing their own tasks under the action.....	51
31.3 Access rights for other beneficiaries, for exploiting their own results.....	51
31.4 Access rights of affiliated entities.....	51
31.5 Access rights for the JU, EU institutions, bodies, offices or agencies and EU Member States.....	51
31.6 Access rights for third parties.....	51
31.7 Consequences of non-compliance.....	52
SECTION 4 OTHER RIGHTS AND OBLIGATIONS.....	52
ARTICLE 32 — RECRUITMENT AND WORKING CONDITIONS FOR RESEARCHERS.....	52
32.1 Obligation to take measures to implement the European Charter for Researchers and Code of Conduct for the Recruitment of Researchers.....	52
32.2 Consequences of non-compliance.....	52
ARTICLE 33 — GENDER EQUALITY.....	52
33.1 Obligation to aim for gender equality.....	52
33.2 Consequences of non-compliance.....	52
ARTICLE 34 — ETHICS.....	52
34.1 Obligation to comply with ethical principles.....	53
34.2 Activities raising ethical issues.....	53

34.3 Activities involving human embryos or human embryonic stem cells.....	54
34.4 Consequences of non-compliance.....	54
ARTICLE 35 — CONFLICT OF INTERESTS.....	54
35.1 Obligation to avoid a conflict of interests.....	54
35.2 Consequences of non-compliance.....	54
ARTICLE 36 — CONFIDENTIALITY.....	54
36.1 General obligation to maintain confidentiality.....	54
36.2 Consequences of non-compliance.....	55
ARTICLE 37 — SECURITY-RELATED OBLIGATIONS.....	55
37.1 Results with a security recommendation.....	55
37.2 Classified results.....	55
37.3 Activities involving dual-use goods or dangerous materials and substances.....	56
37.4 Consequences of non-compliance.....	56
ARTICLE 38 — PROMOTING THE ACTION — VISIBILITY OF SUPPORT.....	56
38.1 Communication activities by beneficiaries.....	56
38.2 Communication activities by the JU.....	57
38.3 Consequences of non-compliance.....	58
ARTICLE 39 — PROCESSING OF PERSONAL DATA.....	58
39.1 Processing of personal data by the JU and the Commission.....	58
39.2 Processing of personal data by the beneficiaries.....	58
39.3 Consequences of non-compliance.....	59
ARTICLE 40 — ASSIGNMENTS OF CLAIMS FOR PAYMENT AGAINST THE JU.....	59
CHAPTER 5 DIVISION OF BENEFICIARIES' ROLES AND RESPONSIBILITIES — RELATIONSHIP WITH COMPLEMENTARY BENEFICIARIES — RELATIONSHIP WITH PARTNERS OF A JOINT ACTION.....	59
ARTICLE 41 — DIVISION OF BENEFICIARIES' ROLES AND RESPONSIBILITIES — RELATIONSHIP WITH COMPLEMENTARY BENEFICIARIES — RELATIONSHIP WITH PARTNERS OF A JOINT ACTION.....	59
41.1 Roles and responsibilities towards the JU.....	59
41.2 Internal division of roles and responsibilities.....	59
41.3 Internal arrangements between beneficiaries — Consortium agreement.....	60
41.4 Relationship with complementary beneficiaries — Collaboration agreement.....	61
41.5 Relationship with partners of a joint action — Coordination agreement.....	61
CHAPTER 6 REJECTION OF COSTS — REDUCTION OF THE GRANT — RECOVERY — PENALTIES — DAMAGES — SUSPENSION — TERMINATION — FORCE MAJEURE.....	61
SECTION 1 REJECTION OF COSTS — REDUCTION OF THE GRANT — RECOVERY — PENALTIES.....	61

ARTICLE 42 — REJECTION OF INELIGIBLE COSTS.....	61
42.1 Conditions.....	61
42.2 Ineligible costs to be rejected — Calculation — Procedure.....	61
42.3 Effects.....	62
ARTICLE 43 — REDUCTION OF THE GRANT.....	62
43.1 Conditions.....	62
43.2 Amount to be reduced — Calculation — Procedure.....	62
43.3 Effects.....	62
ARTICLE 44 — RECOVERY OF UNDUE AMOUNTS.....	63
44.1 Amount to be recovered — Calculation — Procedure.....	63
ARTICLE 45 — ADMINISTRATIVE AND FINANCIAL PENALTIES.....	66
45.1 Conditions.....	67
45.2 Duration — Amount of penalty — Calculation.....	67
45.3 Procedure.....	67
SECTION 2 LIABILITY FOR DAMAGES.....	68
ARTICLE 46 — LIABILITY FOR DAMAGES.....	68
46.1 Liability of the JU.....	68
46.2 Liability of the beneficiaries.....	68
SECTION 3 SUSPENSION AND TERMINATION.....	69
ARTICLE 47 — SUSPENSION OF PAYMENT DEADLINE.....	69
47.1 Conditions.....	69
47.2 Procedure.....	69
ARTICLE 48 — SUSPENSION OF PAYMENTS.....	70
48.1 Conditions.....	70
48.2 Procedure.....	70
ARTICLE 49 — SUSPENSION OF THE ACTION IMPLEMENTATION.....	70
49.1 Suspension of the action implementation, by the beneficiaries.....	70
49.2 Suspension of the action implementation, by the JU.....	71
ARTICLE 50 — TERMINATION OF THE AGREEMENT OR OF THE PARTICIPATION OF ONE OR MORE BENEFICIARIES.....	72
50.1 Termination of the Agreement by the beneficiaries.....	72
50.2 Termination of the participation of one or more beneficiaries, by the beneficiaries.....	73
50.3 Termination of the Agreement or the participation of one or more beneficiaries, by the JU.....	75
SECTION 4 FORCE MAJEURE.....	79

ARTICLE 51 — FORCE MAJEURE.....	79
CHAPTER 7 FINAL PROVISIONS.....	79
ARTICLE 52 — COMMUNICATIONS BETWEEN THE PARTIES.....	79
52.1 Form and means of communication.....	79
52.2 Date of communication.....	80
52.3 Addresses for communication.....	80
ARTICLE 53 — INTERPRETATION OF THE AGREEMENT.....	81
53.1 Precedence of the Terms and Conditions over the Annexes.....	81
53.2 Privileges and immunities.....	81
ARTICLE 54 — CALCULATION OF PERIODS, DATES AND DEADLINES.....	81
ARTICLE 55 — AMENDMENTS TO THE AGREEMENT.....	81
55.1 Conditions.....	81
55.2 Procedure.....	81
ARTICLE 56 — ACCESSION TO THE AGREEMENT.....	82
56.1 Accession of the beneficiaries mentioned in the Preamble.....	82
56.2 Addition of new beneficiaries.....	82
ARTICLE 57 — APPLICABLE LAW AND SETTLEMENT OF DISPUTES.....	82
57.1 Applicable law.....	82
57.2 Dispute settlement.....	82
ARTICLE 58 — ENTRY INTO FORCE OF THE AGREEMENT.....	83

CHAPTER 1 GENERAL

ARTICLE 1 — SUBJECT OF THE AGREEMENT

This Agreement sets out the rights and obligations and the terms and conditions applicable to the grant awarded to the beneficiaries for implementing the action set out in Chapter 2.

CHAPTER 2 ACTION

ARTICLE 2 — ACTION TO BE IMPLEMENTED

The grant is awarded for the action entitled '*Wide band gap Innovative SiC for Advanced Power — WInSiC4AP*' ('**action**'), as described in Annex 1.

ARTICLE 3 — DURATION AND STARTING DATE OF THE ACTION

The duration of the action will be **36 months** as of *1 June 2017* ('**starting date of the action**').

ARTICLE 4 — ESTIMATED BUDGET AND BUDGET TRANSFERS

4.1 Estimated budget

The '**estimated budget**' for the action is set out in Annex 2.

It contains the estimated eligible costs and the forms of costs, broken down by beneficiary (*and linked third party*) and budget category (see Articles 5, 6, and 14).

4.2 Budget transfers

The estimated budget breakdown indicated in Annex 2 may be adjusted by transfers of amounts between budget categories. This does not require an amendment according to Article 55, if the action is implemented as described in Annex 1.

However, the beneficiaries may not add costs relating to subcontracts not provided for in Annex 1, unless such additional subcontracts are approved by an amendment or in accordance with Article 13.

In addition, the estimated budget breakdown indicated in Annex 2 may not be adjusted by transfers of amounts between beneficiaries. This requires in all cases an amendment according to Article 55.

CHAPTER 3 GRANT

ARTICLE 5 — GRANT AMOUNT, FORM OF GRANT, REIMBURSEMENT RATES AND FORMS OF COST

5.1 Maximum grant amount

The '**maximum grant amount**' is **EUR 4,164,282.82** (four million one hundred and sixty four thousand two hundred and eighty two EURO and eighty two eurocents).

5.2 Form of grant, reimbursement rates and forms of costs

The grant reimburses the action's eligible costs (see Article 6) ('**reimbursement of eligible costs grant**') according to the following reimbursement rates (see Annex 2):

- for beneficiaries established in other countries:

30%¹ of the eligible costs of the beneficiaries *and linked third parties* that are SMEs or natural persons,

25%² of the eligible costs of the beneficiaries *and linked third parties* that are for-profit private entities other than SMEs,

35% of the eligible costs of the other beneficiaries *and linked third parties*.

The estimated eligible costs of the action are EUR **15,013,599.75** (fifteen million thirteen thousand five hundred and ninety nine EURO and seventy five eurocents).

Eligible costs (see Article 6) must be declared under the following forms ('**forms of costs**')

(a) for **direct personnel costs**:

- as actually incurred costs ('**actual costs**') or
- on the basis of an amount per unit calculated by the beneficiary in accordance with its usual cost accounting practices ('**unit costs**').

Personnel **costs for SME owners or beneficiaries that are natural persons** not receiving a salary (see Article 6.2, Points A.4 and A.5) must be declared on the basis of the amount per unit set out in Annex 2 (**unit costs**);

(b) for **direct costs for subcontracting**: as actually incurred costs (**actual costs**);

(c) for **direct costs of providing financial support to third parties**: *not applicable*;

(d) for **other direct costs**: as actually incurred costs (**actual costs**);

(e) for **indirect costs**: on the basis of a flat-rate applied as set out in Article 6.2, Point E ('**flat-rate costs**');

(f) *specific cost category(ies): not applicable*.

5.3 Final grant amount — Calculation

The '**final grant amount**' depends on the actual extent to which the action is implemented in accordance with the Agreement's terms and conditions.

This amount is calculated by the JU — when the payment of the balance is made (see Article 21.4) — in the following steps:

¹ The percentage shall only correspond to the reimbursement rate applied by the JU under EU funding rules.

² The percentage shall only correspond to the reimbursement rate applied by the JU under EU funding rules.

Step 1 – Application of the reimbursement rates to the eligible costs

Step 2 – Limit to the maximum grant amount

Step 3 – Reduction due to the no-profit rule

Step 4 – Reduction due to improper implementation or breach of other obligations

5.3.1 Step 1 — Application of the reimbursement rates to the eligible costs

The reimbursement rate(s) (see Article 5.2) are applied to the eligible costs (actual costs, unit costs and flat-rate costs; see Article 6) declared by the beneficiaries *and linked third parties* (see Article 20) and approved by the JU (see Article 21).

5.3.2 Step 2 — Limit to the maximum grant amount

If the amount obtained following Step 1 is higher than the maximum grant amount set out in Article 5.1, it will be limited to the latter.

5.3.3 Step 3 — Reduction due to the no-profit rule

The grant must not produce a profit.

‘**Profit**’ means the surplus of the amount obtained following Steps 1 and 2 plus the action’s total receipts, over the action’s total eligible costs.

The ‘**action’s total eligible costs**’ are the consolidated total eligible costs approved by the JU.

The ‘**action’s total receipts**’ are the consolidated total receipts generated during its duration (see Article 3).

The following are considered **receipts**:

- (a) income generated by the action; if the income is generated from selling equipment or other assets purchased under the Agreement, the receipt is up to the amount declared as eligible under the Agreement;
- (b) financial contributions given by third parties to the beneficiary *or to a linked third party* specifically to be used for the action, and
- (c) in-kind contributions provided by third parties free of charge and specifically to be used for the action, if they have been declared as eligible costs.

The following are however not considered receipts:

- (a) income generated by exploiting the action’s results (see Article 28);
- (b) financial contributions by third parties, if they may be used to cover costs other than the eligible costs (see Article 6);
- (c) financial contributions by third parties with no obligation to repay any amount unused at the end of the period set out in Article 3.

If there is a profit, it will be deducted from the amount obtained following Steps 1 and 2.

5.3.4 Step 4 — Reduction due to improper implementation or breach of other obligations — Reduced grant amount — Calculation

If the grant is reduced (see Article 43), the JU will calculate the reduced grant amount by deducting the amount of the reduction (calculated in proportion to the improper implementation of the action or to the seriousness of the breach of obligations in accordance with Article 43.2) from the maximum grant amount set out in Article 5.1.

The final grant amount will be the lower of the following two:

- the amount obtained following Steps 1 to 3 or
- the reduced grant amount following Step 4.

5.4 Revised final grant amount — Calculation

If — after the payment of the balance (in particular, after checks, reviews, audits or investigations; see Article 22) — the JU rejects costs (see Article 42) or reduces the grant (see Article 43), it will calculate the '**revised final grant amount**' for the beneficiary concerned by the findings.

This amount is calculated by the JU on the basis of the findings, as follows:

- in case of **rejection of costs**: by applying the reimbursement rate to the revised eligible costs approved by the JU for the beneficiary concerned;
- in case of **reduction of the grant**: by calculating the concerned beneficiary's share in the grant amount reduced in proportion to its improper implementation of the action or to the seriousness of its breach of obligations (see Article 43.2).

In case of **rejection of costs and reduction of the grant**, the revised final grant amount for the beneficiary concerned will be the lower of the two amounts above.

ARTICLE 6 — ELIGIBLE AND INELIGIBLE COSTS

6.1 General conditions for costs to be eligible

'**Eligible costs**' are costs that meet the following criteria:

(a) for **actual costs**:

- (i) they must be actually incurred by the beneficiary;
- (ii) they must be incurred in the period set out in Article 3, with the exception of costs relating to the submission of the periodic report for the last reporting period and the final report (see Article 20);
- (iii) they must be indicated in the estimated budget set out in Annex 2;
- (iv) they must be incurred in connection with the action as described in Annex 1 and necessary for its implementation;

- (v) they must be identifiable and verifiable, in particular recorded in the beneficiary's accounts in accordance with the accounting standards applicable in the country where the beneficiary is established and with the beneficiary's usual cost accounting practices;
- (vi) they must comply with the applicable national law on taxes, labour and social security, and
- (vii) they must be reasonable, justified and must comply with the principle of sound financial management, in particular regarding economy and efficiency;

(b) for **unit costs**:

- (i) they must be calculated as follows:

{amounts per unit set out in Annex 2 or calculated by the beneficiary in accordance with its usual cost accounting practices (see Article 6.2, PointA)

multiplied by

the number of actual units};

- (ii) the number of actual units must comply with the following conditions:

- the units must be actually used or produced in the period set out in Article 3;
- the units must be necessary for implementing the action or produced by it, and
- the number of units must be identifiable and verifiable, in particular supported by records and documentation (see Article 18);

(c) for **flat-rate costs**:

- (i) they must be calculated by applying the flat-rate set out in Annex 2, and
- (ii) the costs (actual costs or unit costs) to which the flat-rate is applied must comply with the conditions for eligibility set out in this Article.

6.2 Specific conditions for costs to be eligible

Costs are eligible if they comply with the general conditions (see above) and the specific conditions set out below for each of the following budget categories:

- A. direct personnel costs;
- B. direct costs of subcontracting;
- C. *not applicable*;
- D. other direct costs;
- E. indirect costs;
- F. *not applicable*.

'Direct costs' are costs that are directly linked to the action implementation and can therefore be attributed to it directly. They must not include any indirect costs (see Point E below).

‘Indirect costs’ are costs that are not directly linked to the action implementation and therefore cannot be attributed directly to it.

A. Direct personnel costs

Types of eligible personnel costs

A.1 **Personnel costs** are eligible if they are related to personnel working for the beneficiary under an employment contract (or equivalent appointing act) and assigned to the action (**‘costs for employees (or equivalent)’**). They must be limited to salaries (including during parental leave), social security contributions, taxes and other costs included in the remuneration, if they arise from national law or the employment contract (or equivalent appointing act).

Beneficiaries that are non-profit legal entities³ may also declare as personnel costs **additional remuneration** for personnel assigned to the action (including payments on the basis of supplementary contracts regardless of their nature), if:

- (a) it is part of the beneficiary’s usual remuneration practices and is paid in a consistent manner whenever the same kind of work or expertise is required;
- (b) the criteria used to calculate the supplementary payments are objective and generally applied by the beneficiary, regardless of the source of funding used.

Additional remuneration for personnel assigned to the action is eligible up to the following amount:

- (a) if the person works full time and exclusively on the action during the full year: up to EUR 8 000;
- (b) if the person works exclusively on the action but not full-time or not for the full year: up to the corresponding pro-rata amount of EUR 8 000, or
- (c) if the person does not work exclusively on the action: up to a pro-rata amount calculated as follows:

{ {EUR 8 000

divided by

the number of annual productive hours (see below)},

multiplied by

the number of hours that the person has worked on the action during the year}.

A.2 The **costs for natural persons working under a direct contract** with the beneficiary other than an employment contract are eligible personnel costs, if:

³ For the definition, see Article 2.1(14) of the Rules for Participation Regulation No 1290/2013: ‘**non-profit legal entity**’ means a legal entity which by its legal form is non-profit-making or which has a legal or statutory obligation not to distribute profits to its shareholders or individual members.

- (a) the person works under the beneficiary's instructions and, unless otherwise agreed with the beneficiary, on the beneficiary's premises;
- (b) the result of the work carried out belongs to the beneficiary, and
- (c) the costs are not significantly different from those for personnel performing similar tasks under an employment contract with the beneficiary.

A.3 The **costs of personnel seconded by a third party against payment** are eligible personnel costs, if the conditions in Article 11 are met.

A.4 **Costs of owners** of beneficiaries that are small and medium-sized enterprises ('**SME owners**') who are working on the action and who do not receive a salary are eligible personnel costs, if they correspond to the amount per unit set out in Annex 2 multiplied by the number of actual hours worked on the action.

A.5 **Costs of 'beneficiaries that are natural persons'** not receiving a salary are eligible personnel costs, if they correspond to the amount per unit set out in Annex 2 multiplied by the number of actual hours worked on the action.

Calculation

Personnel costs must be calculated by the beneficiaries as follows:

{hourly rate

multiplied by

the number of actual hours worked on the action},

plus

for non-profit legal entities: additional remuneration to personnel assigned to the action under the conditions set out above (Point A.1)}.

The number of actual hours declared for a person must be identifiable and verifiable (see Article 18).

The total number of hours declared in JU, EU or Euratom grants, for a person for a year, cannot be higher than the annual productive hours used for the calculations of the hourly rate. Therefore, the maximum number of hours that can be declared for the grant are:

{the number of annual productive hours for the year (see below)

minus

total number of hours declared by the beneficiary for that person in that year for other JU, EU or Euratom grants}.

The '**hourly rate**' is one of the following:

- (a) for personnel costs declared as **actual costs**: the hourly rate is the amount calculated as follows:

{actual annual personnel costs (excluding additional remuneration) for the person

divided by

number of annual productive hours}.

The beneficiaries must use the annual personnel costs and the number of annual productive hours for each financial year covered by the reporting period. If a financial year is not closed at the end of the reporting period, the beneficiaries must use the hourly rate of the last closed financial year available.

For the ‘number of annual productive hours’, the beneficiaries may choose one of the following:

- (i) ‘fixed number of hours’: 1 720 hours for persons working full time (or corresponding pro-rata for persons not working full time);
- (ii) ‘individual annual productive hours’: the total number of hours worked by the person in the year for the beneficiary, calculated as follows:

{annual workable hours of the person (according to the employment contract, applicable collective labour agreement or national law)

plus

overtime worked

minus

absences (such as sick leave and special leave)}.

‘Annual workable hours’ means the period during which the personnel must be working, at the employer’s disposal and carrying out his/her activity or duties under the employment contract, applicable collective labour agreement or national working time legislation.

If the contract (or applicable collective labour agreement or national working time legislation) does not allow to determine the annual workable hours, this option cannot be used;

- (iii) ‘standard annual productive hours’: the ‘standard number of annual hours’ generally applied by the beneficiary for its personnel in accordance with its usual cost accounting practices. This number must be at least 90% of the ‘standard annual workable hours’.

If there is no applicable reference for the standard annual workable hours, this option cannot be used.

For all options, the actual time spent on **parental leave** by a person assigned to the action may be deducted from the number of annual productive hours;

- (b) for personnel costs declared on the basis of **unit costs**: the hourly rate is one of the following:
 - (i) for SME owners or beneficiaries that are natural persons: the hourly rate set out in Annex 2 (see Points A.4 and A.5 above), or

(ii) for personnel costs declared on the basis of the beneficiary's usual cost accounting practices: the hourly rate calculated by the beneficiary in accordance with its usual cost accounting practices, if:

- the cost accounting practices used are applied in a consistent manner, based on objective criteria, regardless of the source of funding;
- the hourly rate is calculated using the actual personnel costs recorded in the beneficiary's accounts, excluding any ineligible cost or costs included in other budget categories.

The actual personnel costs may be adjusted by the beneficiary on the basis of budgeted or estimated elements. Those elements must be relevant for calculating the personnel costs, reasonable and correspond to objective and verifiable information;

and

- the hourly rate is calculated using the number of annual productive hours (see above).

B. Direct costs of subcontracting (including related duties, taxes and charges such as non-deductible value added tax (VAT) paid by the beneficiary) are eligible if the conditions in Article 13 are met.

C. Direct costs of providing financial support to third parties *not applicable.*

D. Other direct costs

D.1 Travel costs and related subsistence allowances (including related duties, taxes and charges such as non-deductible value added tax (VAT) paid by the beneficiary) are eligible if they are in line with the beneficiary's usual practices on travel.

D.2 *The depreciation costs of equipment, infrastructure or other assets (new or second-hand) as recorded in the beneficiary's accounts are eligible, if they were purchased in accordance with Article 10.1.1 and written off in accordance with international accounting standards and the beneficiary's usual accounting practices.*

The costs of renting or leasing equipment, infrastructure or other assets (including related duties, taxes and charges such as non-deductible value added tax (VAT) paid by the beneficiary) are also eligible, if they do not exceed the depreciation costs of similar equipment, infrastructure or assets and do not include any financing fees.

*The costs of equipment, infrastructure or other assets **contributed in-kind against payment** are eligible, if they do not exceed the depreciation costs of similar equipment, infrastructure or assets, do not include any financing fees and if the conditions in Article 11.1 are met.*

The only portion of the costs that will be taken into account is that which corresponds to the duration of the action and rate of actual use for the purposes of the action.

D.3 Costs of other goods and services (including related duties, taxes and charges such as non-deductible value added tax (VAT) paid by the beneficiary) are eligible, if they are:

- (a) purchased specifically for the action and in accordance with Article 10.1.1 or
- (b) contributed in kind against payment and in accordance with Article 11.1.

Such goods and services include, for instance, consumables and supplies, dissemination (including open access), protection of results, certificates on the financial statements (if they are required by the Agreement), certificates on the methodology, translations and publications.

D.4 Capitalised and operating costs of ‘large research infrastructure’⁴ *directly used for the action are eligible, if:*

- (a) the value of the large research infrastructure represents at least 75% of the total fixed assets (at historical value in its last closed balance sheet before the date of the signature of the Agreement or as determined on the basis of the rental and leasing costs of the research infrastructure⁵);*
- (b) the beneficiary’s methodology for declaring the costs for large research infrastructure has been positively assessed by the Commission (‘ex-ante assessment’);*
- (c) the beneficiary declares as direct eligible costs only the portion which corresponds to the duration of the action and the rate of actual use for the purposes of the action, and*
- (d) they comply with the conditions as further detailed in the annotations to the Horizon 2020 grant agreements.*

E. Indirect costs

Indirect costs are eligible if they are declared on the basis of the flat-rate of 25% of the eligible direct costs (see Article 5.2 and Points A to D above), from which are excluded:

- (a) costs of subcontracting and
- (b) costs of in-kind contributions provided by third parties which are not used on the beneficiary’s premises;

⁴ ‘**Large research infrastructure**’ means research infrastructure of a total value of at least EUR 20 million, for a beneficiary, calculated as the sum of historical asset values of each individual research infrastructure of that beneficiary, as they appear in its last closed balance sheet before the date of the signature of the Agreement or as determined on the basis of the rental and leasing costs of the research infrastructure.

⁵ For the definition, see Article 2(6) of Regulation (EU) No 1291/2013 of the European Parliament and of the Council of 11 December 2013 establishing Horizon 2020 - the Framework Programme for Research and Innovation (2014-2020) (OJ L 347, 20.12.2013 p.104)-(**‘Horizon 2020 Framework Programme Regulation No 1291/2013’**): ‘**Research infrastructure**’ are facilities, resources and services that are used by the research communities to conduct research and foster innovation in their fields. Where relevant, they may be used beyond research, e.g. for education or public services. They include: major scientific equipment (or sets of instruments); knowledge-based resources such as collections, archives or scientific data; e-infrastructures such as data and computing systems and communication networks; and any other infrastructure of a unique nature essential to achieve excellence in research and innovation. Such infrastructures may be ‘single-sited’, ‘virtual’ or ‘distributed’.

(c) *not applicable*;

(d) *not applicable*.

Beneficiaries receiving an operating grant⁶ financed by the EU or Euratom budget cannot declare indirect costs for the period covered by the operating grant.

F. Specific cost category(ies)

Not applicable

6.3 Conditions for costs of linked third parties to be eligible

Costs incurred by linked third parties are eligible if they fulfil — mutatis mutandis — the general and specific conditions for eligibility set out in this Article (Article 6.1 and 6.2) and Article 14.1.1.

6.4 Conditions for in-kind contributions provided by third parties free of charge to be eligible

In-kind contributions provided free of charge are eligible direct costs (for the beneficiary *or linked third party*), if the costs incurred by the third party fulfil — *mutatis mutandis* — the general and specific conditions for eligibility set out in this Article (Article 6.1 and 6.2) and Article 12.1.

6.5 Ineligible costs

‘**Ineligible costs**’ are:

(a) costs that do not comply with the conditions set out above (Article 6.1 to 6.4), in particular:

- (i) costs related to return on capital;
- (ii) debt and debt service charges;
- (iii) provisions for future losses or debts;
- (iv) interest owed;
- (v) doubtful debts;
- (vi) currency exchange losses;
- (vii) bank costs charged by the beneficiary’s bank for transfers from the JU;
- (viii) excessive or reckless expenditure;
- (ix) deductible VAT;

⁶ For the definition, see Article 121(1)(b) of Regulation (EU, Euratom) No 966/2012 of the European Parliament and of the Council of 25 October 2012 on the financial rules applicable to the general budget of the Union and repealing Council Regulation (EC, Euratom) No 1605/2002 (OJ L 218, 26.10.2012, p.1) (‘**Financial Regulation No 966/2012**’): ‘**operating grant**’ means direct financial contribution, by way of donation, from the budget in order to finance the functioning of a body which pursues an aim of general EU interest or has an objective forming part of and supporting an EU policy.

- (x) costs incurred during suspension of the implementation of the action (see Article 49);
- (b) costs declared under another JU, EU or Euratom grant (including other grants awarded by the JU, grants awarded by a Member State and financed by the EU or Euratom budget and grants awarded by bodies other than the JU for the purpose of implementing the EU or Euratom budget); in particular, indirect costs if the beneficiary is already receiving an operating grant financed by the EU or Euratom budget in the same period.

6.6 Consequences of declaration of ineligible costs

Declared costs that are ineligible will be rejected (see Article 42).

This may also lead to any of the other measures described in Chapter 6.

CHAPTER 4 RIGHTS AND OBLIGATIONS OF THE PARTIES

SECTION 1 RIGHTS AND OBLIGATIONS RELATED TO IMPLEMENTING THE ACTION

ARTICLE 7 — GENERAL OBLIGATION TO PROPERLY IMPLEMENT THE ACTION

7.1 General obligation to properly implement the action

The beneficiaries must implement the action as described in Annex 1 and in compliance with the provisions of the Agreement and all legal obligations under applicable EU, international and national law.

7.2 Consequences of non-compliance

If a beneficiary breaches any of its obligations under this Article, the grant may be reduced (see Article 43).

Such breaches may also lead to any of the other measures described in Chapter 6.

ARTICLE 8 — RESOURCES TO IMPLEMENT THE ACTION — THIRD PARTIES INVOLVED IN THE ACTION

The beneficiaries must have the appropriate resources to implement the action.

If it is necessary to implement the action, the beneficiaries may:

- purchase goods, works and services (see Article 10);
- use in-kind contributions provided by third parties against payment (see Article 11);
- use in-kind contributions provided by third parties free of charge (see Article 12);
- call upon subcontractors to implement action tasks described in Annex 1 (see Article 13);

- call upon linked third parties to implement action tasks described in Annex 1 (see Article 14).

In these cases, the beneficiaries retain sole responsibility towards the JU and the other beneficiaries for implementing the action.

ARTICLE 9 — IMPLEMENTATION OF ACTION TASKS BY BENEFICIARIES NOT RECEIVING JU FUNDING

Not applicable

ARTICLE 10 — PURCHASE OF GOODS, WORKS OR SERVICES

10.1 Rules for purchasing goods, works or services

10.1.1 If necessary to implement the action, the beneficiaries may purchase goods, works or services.

The beneficiaries must make such purchases ensuring the best value for money or, if appropriate, the lowest price. In doing so, they must avoid any conflict of interests (see Article 35).

The beneficiaries must ensure that the JU, the Commission, the European Court of Auditors (ECA) and the European Anti-Fraud Office (OLAF) can exercise their rights under Articles 22 and 23 also towards their contractors.

10.1.2 Beneficiaries that are ‘contracting authorities’ within the meaning of Directive 2004/18/EC⁷ or ‘contracting entities’ within the meaning of Directive 2004/17/EC⁸ must comply with the applicable national law on public procurement.

10.2 Consequences of non-compliance

If a beneficiary breaches any of its obligations under Article 10.1.1, the costs related to the contract concerned will be ineligible (see Article 6) and will be rejected (see Article 42).

If a beneficiary breaches any of its obligations under Article 10.1.2, the grant may be reduced (see Article 43).

Such breaches may also lead to any of the other measures described in Chapter 6.

ARTICLE 11 — USE OF IN-KIND CONTRIBUTIONS PROVIDED BY THIRD PARTIES AGAINST PAYMENT

11.1 Rules for the use of in-kind contributions against payment

If necessary to implement the action, the beneficiaries may use in-kind contributions provided by third parties against payment.

⁷ Directive 2004/18/EC of the European Parliament and of the Council of 31 March 2004 on the coordination of procedures for the award of public work contracts, public supply contracts and public service contracts (OJ L 134, 30.04.2004, p. 114).

⁸ Directive 2004/17/EC of the European Parliament and of the Council of 31 March 2004 coordinating the procurement procedures of entities operating in the water, energy, transport and postal services sectors (OJ L 134, 30.04.2004, p. 1).

The beneficiaries may declare costs related to the payment of in-kind contributions as eligible (see Article 6.1 and 6.2), up to the third parties' costs for the seconded persons, contributed equipment, infrastructure or other assets or other contributed goods and services.

The third parties and their contributions must be set out in Annex 1. The JU may however approve in-kind contributions not set out in Annex 1 without amendment (see Article 55), if:

- they are specifically justified in the periodic technical report and
- their use does not entail changes to the Agreement which would call into question the decision awarding the grant or breach the principle of equal treatment of applicants.

The beneficiaries must ensure that the JU, the Commission, the European Court of Auditors (ECA) and the European Anti-Fraud Office (OLAF) can exercise their rights under Articles 22 and 23 also towards the third parties.

11.2 Consequences of non-compliance

If a beneficiary breaches any of its obligations under this Article, the costs related to the payment of the in-kind contribution will be ineligible (see Article 6) and will be rejected (see Article 42).

Such breaches may also lead to any of the other measures described in Chapter 6.

ARTICLE 12 — USE OF IN-KIND CONTRIBUTIONS PROVIDED BY THIRD PARTIES FREE OF CHARGE

12.1 Rules for the use of in-kind contributions free of charge

If necessary to implement the action, the beneficiaries may use in-kind contributions provided by third parties free of charge.

The beneficiaries may declare costs incurred by the third parties for the seconded persons, contributed equipment, infrastructure or other assets or other contributed goods and services as eligible in accordance with Article 6.4.

The third parties and their contributions must be set out in Annex 1. The JU may however approve in-kind contributions not set out in Annex 1 without amendment (see Article 55), if:

- they are specifically justified in the periodic technical report and
- their use does not entail changes to the Agreement which would call into question the decision awarding the grant or breach the principle of equal treatment of applicants.

The beneficiaries must ensure that the JU, the Commission, the European Court of Auditors (ECA) and the European Anti-Fraud Office (OLAF) can exercise their rights under Articles 22 and 23 also towards the third parties.

12.2 Consequences of non-compliance

If a beneficiary breaches any of its obligations under this Article, the costs incurred by the third parties related to the in-kind contribution will be ineligible (see Article 6) and will be rejected (see Article 42).

Such breaches may also lead to any of the other measures described in Chapter 6.

ARTICLE 13 — IMPLEMENTATION OF ACTION TASKS BY SUBCONTRACTORS

13.1 Rules for subcontracting action tasks

13.1.1 If necessary to implement the action, the beneficiaries may award subcontracts covering the implementation of certain action tasks described in Annex 1.

Subcontracting may cover only a limited part of the action.

The beneficiaries must award the subcontracts ensuring the best value for money or, if appropriate, the lowest price. In doing so, they must avoid any conflict of interests (see Article 35).

The tasks to be implemented and the estimated cost for each subcontract must be set out in Annex 1 and the total estimated costs of subcontracting per beneficiary must be set out in Annex 2. The JU may however approve subcontracts not set out in Annex 1 and 2 without amendment (see Article 55), if:

- they are specifically justified in the periodic technical report and
- they do not entail changes to the Agreement which would call into question the decision awarding the grant or breach the principle of equal treatment of applicants.

The beneficiaries must ensure that the JU, the Commission, the European Court of Auditors (ECA) and the European Anti-Fraud Office (OLAF) can exercise their rights under Articles 22 and 23 also towards their subcontractors.

13.1.2 The beneficiaries must ensure that their obligations under Articles 35, 36, 38 and 46 also apply to the subcontractors.

Beneficiaries that are ‘contracting authorities’ within the meaning of Directive 2004/18/EC or ‘contracting entities’ within the meaning of Directive 2004/17/EC must comply with the applicable national law on public procurement.

13.2 Consequences of non-compliance

If a beneficiary breaches any of its obligations under Article 13.1.1, the costs related to the subcontract concerned will be ineligible (see Article 6) and will be rejected (see Article 42).

If a beneficiary breaches any of its obligations under Article 13.1.2, the grant may be reduced (see Article 43).

Such breaches may also lead to any of the other measures described in Chapter 6.

ARTICLE 14 — IMPLEMENTATION OF ACTION TASKS BY LINKED THIRD PARTIES

14.1 Rules for calling upon linked third parties to implement part of the action

*14.1.1 The following **affiliated entities**¹⁰ and **third parties with a legal link to a beneficiary**¹¹ ('**linked third parties**') may implement the action tasks attributed to them in Annex 1:*

- *UNIVERSITA DEGLI STUDI DI PALERMO (UNIPA), affiliated or linked to DTSMNS*
- *UNIVERSITA DEGLI STUDI DI PADOVA (UNIPD), affiliated or linked to IUNET*
- *ALMA MATER STUDIORUM - UNIVERSITA DI BOLOGNA (UNIBO), affiliated or linked to IUNET*
- *UNIVERSITA DELLA CALABRIA (UNICAL), affiliated or linked to IUNET*
- *OFFICINE MECCANICHE IRPINE SRL (Caltec/OMI), affiliated or linked to DAC*
- *REDAM SRL (Caltec/REDAM), affiliated or linked to DAC*

The linked third parties may declare as eligible the costs they incur for implementing the action tasks in accordance with Article 6.3.

The beneficiaries must ensure that the JU, the Commission, the European Court of Auditors (ECA) and the European Anti-Fraud Office (OLAF) can exercise their rights under Articles 22 and 23 also towards their linked third parties.

14.1.2 The beneficiaries must ensure that their obligations under Articles 18, 20, 35, 36 and 38 also apply to their linked third parties.

14.2 Consequences of non-compliance

If any obligation under Article 14.1.1 is breached, the costs of the linked third party will be ineligible (see Article 6) and will be rejected (see Article 42).

If any obligation under Article 14.1.2 is breached, the grant may be reduced (see Article 43).

Such breaches may also lead to any of the other measures described in Chapter 6.

¹⁰ For the definition, see Article 2.1(2) of the Rules for Participation Regulation No 1290/2013: '**affiliated entity**' means any legal entity that is:

- under the direct or indirect control of a participant, or
- under the same direct or indirect control as the participant, or
- directly or indirectly controlling a participant.

'Control' may take any of the following forms:

- (a) the direct or indirect holding of more than 50% of the nominal value of the issued share capital in the legal entity concerned, or of a majority of the voting rights of the shareholders or associates of that entity;
- (b) the direct or indirect holding, in fact or in law, of decision-making powers in the legal entity concerned.

However the following relationships between legal entities shall not in themselves be deemed to constitute controlling relationships:

- (a) the same public investment corporation, institutional investor or venture-capital company has a direct or indirect holding of more than 50% of the nominal value of the issued share capital or a majority of voting rights of the shareholders or associates;
- (b) the legal entities concerned are owned or supervised by the same public body.

¹¹ '**Third party with a legal link to a beneficiary**' is any legal entity which has a legal link to the beneficiary implying collaboration that is not limited to the action.

ARTICLE 15 — FINANCIAL SUPPORT TO THIRD PARTIES

15.1 Rules for providing financial support to third parties

Not applicable

15.2 Financial support in the form of prizes

Not applicable

15.3 Consequences of non-compliance

Not applicable

ARTICLE 16 — PROVISION OF TRANS-NATIONAL OR VIRTUAL ACCESS TO RESEARCH INFRASTRUCTURE

16.1 Rules for providing trans-national access to research infrastructure

Not applicable

16.2 Rules for providing virtual access to research infrastructure

Not applicable

16.3 Consequences of non-compliance

Not applicable

SECTION 2 RIGHTS AND OBLIGATIONS RELATED TO THE GRANT ADMINISTRATION

ARTICLE 17 — GENERAL OBLIGATION TO INFORM

17.1 General obligation to provide information upon request

The beneficiaries must provide — during implementation of the action or afterwards and in accordance with Article 41.2 — any information requested in order to verify eligibility of the costs, proper implementation of the action and compliance with any other obligation under the Agreement.

17.2 Obligation to keep information up to date and to inform about events and circumstances likely to affect the Agreement

Each beneficiary must keep information stored in the 'Beneficiary Register' (via the electronic exchange system; see Article 52) up to date, in particular, its name, address, legal representatives, legal form and organisation type.

Each beneficiary must immediately inform the coordinator — which must immediately inform the JU and the other beneficiaries — of any of the following:

- (a) **events** which are likely to affect significantly or delay the implementation of the action or the EU's or JU's financial interests, in particular:

- (i) changes in its legal, financial, technical, organisational or ownership situation *or those of its linked third parties and*
 - (ii) *changes in the name, address, legal form, organisation type of its linked third parties;*
- (b) **circumstances** affecting:
- (i) the decision to award the grant or
 - (ii) compliance with requirements under the Agreement.

17.3 Consequences of non-compliance

If a beneficiary breaches any of its obligations under this Article, the grant may be reduced (see Article 43).

Such breaches may also lead to any of the other measures described in Chapter 6.

ARTICLE 18 — KEEPING RECORDS — SUPPORTING DOCUMENTATION

18.1 Obligation to keep records and other supporting documentation

The beneficiaries must — for a period of *five* years after the payment of the balance — keep records and other supporting documentation in order to prove the proper implementation of the action and the costs they declare as eligible.

They must make them available upon request (see Article 17) or in the context of checks, reviews, audits or investigations (see Article 22).

If there are on-going checks, reviews, audits, investigations, litigation or other pursuits of claims under the Agreement (including the extension of findings; see Articles 22), the beneficiaries must keep the records and other supporting documentation until the end of these procedures.

The beneficiaries must keep the original documents. Digital and digitalised documents are considered originals if they are authorised by the applicable national law. The JU or the Commission may accept non-original documents if it considers that they offer a comparable level of assurance.

18.1.1 Records and other supporting documentation on the scientific and technical implementation

The beneficiaries must keep records and other supporting documentation on scientific and technical implementation of the action in line with the accepted standards in the respective field.

18.1.2 Records and other documentation to support the costs declared

The beneficiaries must keep the records and documentation supporting the costs declared, in particular the following:

- (a) for **actual costs**: adequate records and other supporting documentation to prove the costs declared, such as contracts, subcontracts, invoices and accounting records. In addition, the

beneficiaries' usual cost accounting practices and internal control procedures must enable direct reconciliation between the amounts declared, the amounts recorded in their accounts and the amounts stated in the supporting documentation;

- (b) for **unit costs**: adequate records and other supporting documentation to prove the number of units declared. Beneficiaries do not need to identify the actual eligible costs covered or to keep or provide supporting documentation (such as accounting statements) to prove the amount per unit.

In addition, for **direct personnel costs declared as unit costs calculated in accordance with the beneficiary's usual cost accounting practices**, the beneficiaries must keep adequate records and documentation to prove that the cost accounting practices used comply with the conditions set out in Article 6.2, Point A.

The beneficiaries *and linked third parties* may submit to the JU, for approval by the Commission, a certificate (drawn up in accordance with Annex 6) stating that their usual cost accounting practices comply with these conditions (**'certificate on the methodology'**). If the certificate is approved, costs declared in line with this methodology will not be challenged subsequently, unless the beneficiaries have concealed information for the purpose of the approval.

- (c) for **flat-rate costs**: adequate records and other supporting documentation to prove the eligibility of the costs to which the flat-rate is applied. The beneficiaries do not need to identify the costs covered or provide supporting documentation (such as accounting statements) to prove the amount declared at a flat-rate.

In addition, for **personnel costs** (declared as actual costs or on the basis of unit costs), the beneficiaries must keep **time records** for the number of hours declared. The time records must be in writing and approved by the persons working on the action and their supervisors, at least monthly. In the absence of reliable time records of the hours worked on the action, the JU or the Commission may accept alternative evidence supporting the number of hours declared, if it considers that it offers an adequate level of assurance.

As an exception, for **persons working exclusively on the action**, there is no need to keep time records, if the beneficiary signs a **declaration** confirming that the persons concerned have worked exclusively on the action.

For costs declared by linked third parties (see Article 14), it is the beneficiary that must keep the originals of the financial statements and the certificates on the financial statements of the linked third parties.

18.2 Consequences of non-compliance

If a beneficiary breaches any of its obligations under this Article, costs insufficiently substantiated will be ineligible (see Article 6) and will be rejected (see Article 42), and the grant may be reduced (see Article 43).

Such breaches may also lead to any of the other measures described in Chapter 6.

ARTICLE 19 — SUBMISSION OF DELIVERABLES

19.1 Obligation to submit deliverables

The coordinator must submit the ‘**deliverables**’ identified in Annex 1, in accordance with the timing and conditions set out in it.

19.2 Consequences of non-compliance

If the coordinator breaches any of its obligations under this Article, the JU may apply any of the measures described in Chapter 6.

ARTICLE 20 — REPORTING — PAYMENT REQUESTS

20.1 Obligation to submit reports

The coordinator must submit to the JU (see Article 52) the technical and financial reports set out in this Article. These reports include requests for payment and must be drawn up using the forms and templates provided in the electronic exchange system (see Article 52).

20.2 Reporting periods

The action is divided into the following ‘**reporting periods**’:

- RP1: from month 1 to month 12
- RP2: *from month 13 to month 24*
- RP3: *from month 25 to month 36*

20.3 Periodic reports — Requests for interim payments

The coordinator must submit a periodic report within 60 days following the end of each reporting period.

The **periodic report** must include the following:

(a) a ‘**periodic technical report**’ containing:

- (i) an **explanation of the work carried out** by the beneficiaries;
- (ii) an **overview of the progress** towards the objectives of the action, including milestones and deliverables identified in Annex 1.

This report must include explanations justifying the differences between work expected to be carried out in accordance with Annex 1 and that actually carried out.

The report must also detail the exploitation and dissemination of the results and — if required in Annex 1 — an updated ‘**plan for the exploitation and dissemination of the results**’;

- (iii) a **summary** for publication by the JU;
- (iv) the answers to the ‘**questionnaire**’, covering issues related to the action implementation and the economic and societal impact, notably in the context of the key performance indicators and monitoring requirements of Horizon 2020 and the JU;

(b) a ‘**periodic financial report**’ containing:

- (i) an ‘**individual financial statement**’ (see Annex 4) from each beneficiary *and from each linked third party*, for the reporting period concerned.

The individual financial statement must detail the eligible costs (actual costs, unit costs and flat-rate costs; see Article 6) for each budget category (see Annex 2).

The beneficiaries *and linked third parties* must declare all eligible costs, even if — for actual costs, unit costs and flat-rate costs — they exceed the amounts indicated in the estimated budget (see Annex 2). Amounts which are not declared in the individual financial statement will not be taken into account by the JU.

If an individual financial statement is not submitted for a reporting period, it may be included in the periodic financial report for the next reporting period.

The individual financial statements of the last reporting period must also detail the **receipts of the action** (see Article 5.3.3).

Each beneficiary *and each linked third party* must **certify** that:

- the information provided is full, reliable and true;
- the costs declared are eligible (see Article 6);
- the costs can be substantiated by adequate records and supporting documentation (see Article 18) that will be produced upon request (see Article 17) or in the context of checks, reviews, audits and investigations (see Article 22), and
- for the last reporting period: that all the receipts have been declared (see Article 5.3.3);

- (ii) an **explanation of the use of resources** and the information on subcontracting (see Article 13) and in-kind contributions provided by third parties (see Articles 11 and 12) from each beneficiary *and from each linked third party*, for the reporting period concerned;

(iii) not applicable;

- (iv) a ‘**periodic summary financial statement**’ (see Annex 4), created automatically by the electronic exchange system, consolidating the individual financial statements for the reporting period concerned and including — except for the last reporting period — the **request for interim payment**.

20.4 Final report — Request for payment of the balance

In addition to the periodic report for the last reporting period, the coordinator must submit the final report within 60 days following the end of the last reporting period.

The **final report** must include the following:

- (a) a ‘**final technical report**’ with a **summary** for publication containing:
- (i) an overview of the results and their exploitation and dissemination;
 - (ii) the conclusions on the action, and
 - (iii) the socio-economic impact of the action;
- (b) a ‘**final financial report**’ containing:
- (i) a ‘**final summary financial statement**’ (see Annex 4), created automatically by the electronic exchange system, consolidating the individual financial statements for all reporting periods and including the **request for payment of the balance** and
 - (ii) a ‘**certificate on the financial statements**’ (drawn up in accordance with Annex 5) for each beneficiary *and for each linked third party*, if it requests a total contribution of EUR 325 000 or more, as reimbursement of actual costs and unit costs calculated on the basis of its usual cost accounting practices (see Article 5.2 and Article 6.2, Point A).

20.5 Information on cumulative expenditure incurred

Not applicable

20.6 Currency for financial statements and conversion into euro

Financial statements must be drafted in euro.

Beneficiaries *and linked third parties* with accounting established in a currency other than the euro must convert the costs recorded in their accounts into euro, at the average of the daily exchange rates published in the C series of the *Official Journal of the European Union*, calculated over the corresponding reporting period.

If no daily euro exchange rate is published in the *Official Journal of the European Union* for the currency in question, they must be converted at the average of the monthly accounting rates published on the Commission’s website, calculated over the corresponding reporting period.

Beneficiaries *and linked third parties* with accounting established in euro must convert costs incurred in another currency into euro according to their usual accounting practices.

20.7 Language of reports

All reports (technical and financial reports, including financial statements) must be submitted in the language of the Agreement.

20.8 Consequences of non-compliance — Suspension of the payment deadline — Termination

If the reports submitted do not comply with this Article, the JU may suspend the payment deadline (see Article 47) and apply any of the other measures described in Chapter 6.

If the coordinator breaches its obligation to submit the reports and if it fails to comply with this obligation within 30 days following a written reminder sent by the JU, the Agreement may be terminated (see Article 50).

ARTICLE 21 — PAYMENTS AND PAYMENT ARRANGEMENTS

21.1 Payments to be made

The following payments will be made to the coordinator:

- one **pre-financing payment**;
- one or more **interim payments**, on the basis of the request(s) for interim payment (see Article 20), and
- one **payment of the balance**, on the basis of the request for payment of the balance (see Article 20).

21.2 Pre-financing payment — Amount — Amount retained for the Guarantee Fund

The aim of the pre-financing is to provide the beneficiaries with a float.

It remains the property of the JU until the payment of the balance.

The amount of the pre-financing payment will be EUR **2,220,950.84** (two million two hundred and twenty thousand nine hundred and fifty EURO and eighty four eurocents).

The JU will — except if Article 48 applies — make the pre-financing payment to the coordinator within 30 days either from the entry into force of the Agreement (see Article 58) or from 10 days before the starting date of the action (see Article 3), whichever is the latest.

An amount of EUR **208,214.14** (two hundred and eight thousand two hundred and fourteen EURO and fourteen eurocents), corresponding to 5% of the maximum grant amount (see Article 5.1), is retained by the JU from the pre-financing payment and transferred into the '**Guarantee Fund**'.

21.3 Interim payments — Amount — Calculation

Interim payments reimburse the eligible costs incurred for the implementation of the action during the corresponding reporting periods.

The JU will pay to the coordinator the amount due as interim payment within 90 days from receiving the periodic report (see Article 20.3), except if Articles 47 or 48 apply.

Payment is subject to the approval of the periodic report. Its approval does not imply recognition of the compliance, authenticity, completeness or correctness of its content.

The **amount due as interim payment** is calculated by the JU in the following steps:

Step 1 – Application of the reimbursement rates

Step 2 – Limit to 90% of the maximum grant amount

21.3.1 Step 1 — Application of the reimbursement rates

The reimbursement rate(s) (see Article 5.2) are applied to the eligible costs (actual costs, unit costs and flat-rate costs ; see Article 6) declared by the beneficiaries *and the linked third parties* (see Article 20) and approved by the JU (see above) for the concerned reporting period.

21.3.2 Step 2 — Limit to 90% of the maximum grant amount

The total amount of pre-financing and interim payments must not exceed 90% of the maximum grant amount set out in Article 5.1. The maximum amount for the interim payment will be calculated as follows:

{90% of the maximum grant amount (see Article 5.1)

minus

{pre-financing and previous interim payments}}.

21.4 Payment of the balance — Amount — Calculation — Release of the amount retained for the Guarantee Fund

The payment of the balance reimburses the remaining part of the eligible costs incurred by the beneficiaries for the implementation of the action.

If the total amount of earlier payments is greater than the final grant amount (see Article 5.3), the payment of the balance takes the form of a recovery (see Article 44).

If the total amount of earlier payments is lower than the final grant amount, the JU will pay the balance within 90 days from receiving the final report (see Article 20.4), except if Articles 47 or 48 apply.

Payment is subject to the approval of the final report. Its approval does not imply recognition of the compliance, authenticity, completeness or correctness of its content.

The **amount due as the balance** is calculated by the JU by deducting the total amount of pre-financing and interim payments (if any) already made, from the final grant amount determined in accordance with Article 5.3:

{final grant amount (see Article 5.3)

minus

{pre-financing and interim payments (if any) made}}.

At the payment of the balance, the amount retained for the Guarantee Fund (see above) will be released and:

- if the balance is positive: the amount released will be paid in full to the coordinator together with the amount due as the balance;
- if the balance is negative (payment of the balance taking the form of recovery): it will be deducted from the amount released (see Article 44.1.2). If the resulting amount:
 - is positive, it will be paid to the coordinator
 - is negative, it will be recovered.

The amount to be paid may however be offset — without the beneficiary's consent — against any other amount owed by the beneficiary to the JU up to the maximum JU contribution indicated, for that beneficiary, in the estimated budget (see Annex 2).

21.5 Notification of amounts due

When making payments, the JU will formally notify to the coordinator the amount due, specifying whether it concerns an interim payment or the payment of the balance.

For the payment of the balance, the notification will also specify the final grant amount.

In the case of reduction of the grant or recovery of undue amounts, the notification will be preceded by the contradictory procedure set out in Articles 43 and 44.

21.6 Currency for payments

The JU will make all payments in euro.

21.7 Payments to the coordinator — Distribution to the beneficiaries

Payments will be made to the coordinator.

Payments to the coordinator will discharge the JU from its payment obligation.

The coordinator must distribute the payments between the beneficiaries without unjustified delay.

Pre-financing may however be distributed only:

- (a) if the minimum number of beneficiaries set out in the call for proposals has acceded to the Agreement (see Article 56) and
- (b) to beneficiaries that have acceded to the Agreement (see Article 56).

21.8 Bank account for payments

All payments will be made to the following bank account:

Name of bank: UNICREDIT SPA

Address of branch: PIAZZA GIOVANNI VERGA, 43 CATANIA, Italy

Full name of the account holder: DISTRETTO TEC SICILIA MICRO E NANOSISTEMI SCARL

Full account number (including bank codes):

IBAN code: IT33D0200816934000101286624

21.9 Costs of payment transfers

The cost of the payment transfers is borne as follows:

- the JU bears the cost of transfers charged by its bank;
- the beneficiary bears the cost of transfers charged by its bank;
- the party causing a repetition of a transfer bears all costs of the repeated transfer.

21.10 Date of payment

Payments by the JU are considered to have been carried out on the date when they are debited to its account.

21.11 Consequences of non-compliance

21.11.1 If the JU does not pay within the payment deadlines (see above), the beneficiaries are entitled to **late-payment interest** at the rate applied by the European Central Bank (ECB) for its main refinancing operations in euros ('reference rate'), plus three and a half points. The reference rate is the rate in force on the first day of the month in which the payment deadline expires, as published in the C series of the *Official Journal of the European Union*.

If the late-payment interest is lower than or equal to EUR 200, it will be paid to the coordinator only upon request submitted within two months of receiving the late payment.

Late-payment interest is not due if all beneficiaries are EU Member States (including regional and local government authorities or other public bodies acting on behalf of a Member State for the purpose of this Agreement).

Suspension of the payment deadline or payments (see Articles 47 and 48) will not be considered as late payment.

Late-payment interest covers the period running from the day following the due date for payment (see above), up to and including the date of payment.

Late-payment interest is not considered for the purposes of calculating the final grant amount.

21.11.2 If the coordinator breaches any of its obligations under this Article, the grant may be reduced (see Article 43) and the Agreement or the participation of the coordinator may be terminated (see Article 50).

Such breaches may also lead to any of the other measures described in Chapter 6.

ARTICLE 22 — CHECKS, REVIEWS, AUDITS AND INVESTIGATIONS — EXTENSION OF FINDINGS

22.1 Checks, reviews and audits by the Commission and the JU

22.1.1 Right to carry out checks

The JU will — during the implementation of the action or afterwards — check the proper implementation of the action and compliance with the obligations under the Agreement, including assessing deliverables and reports.

For this purpose the JU may be assisted by external persons or bodies.

The JU may also request additional information in accordance with Article 17. The JU may request beneficiaries to provide such information to it directly.

Information provided must be accurate, precise and complete and in the format requested, including electronic format.

22.1.2 Right to carry out reviews

The JU may — during the implementation of the action or afterwards — carry out reviews on the proper implementation of the action (including assessment of deliverables and reports), compliance with the obligations under the Agreement and continued scientific or technological relevance of the action.

Reviews may be started **up to two years after the payment of the balance**. They will be formally notified to the coordinator or beneficiary concerned and will be considered to have started on the date of the formal notification.

If the review is carried out on a third party (see Articles 10 to 16), the beneficiary concerned must inform the third party.

The JU may carry out reviews directly (using its own staff) or indirectly (using external persons or bodies appointed to do so). It will inform the coordinator or beneficiary concerned of the identity of the external persons or bodies. They have the right to object to the appointment on grounds of commercial confidentiality.

The coordinator or beneficiary concerned must provide — within the deadline requested — any information and data in addition to deliverables and reports already submitted (including information on the use of resources). The JU may request beneficiaries to provide such information to it directly.

The coordinator or beneficiary concerned may be requested to participate in meetings, including with external experts.

For **on-the-spot** reviews, the beneficiaries must allow access to their sites and premises, including to external persons or bodies, and must ensure that information requested is readily available.

Information provided must be accurate, precise and complete and in the format requested, including electronic format.

On the basis of the review findings, a ‘**review report**’ will be drawn up.

The JU will formally notify the review report to the coordinator or beneficiary concerned, which has 30 days to formally notify observations (‘contradictory review procedure’).

Reviews (including review reports) are in the language of the Agreement.

22.1.3 Right to carry out audits

The JU or the Commission may — during the implementation of the action or afterwards — carry out audits on the proper implementation of the action and compliance with the obligations under the Agreement.

Audits may be started **up to two years after the payment of the balance**. They will be formally notified to the coordinator or beneficiary concerned and will be considered to have started on the date of the formal notification.

If the audit is carried out on a third party (see Articles 10 to 16), the beneficiary concerned must inform the third party.

The JU or the Commission may carry out audits directly (using its own staff) or indirectly (using external persons or bodies appointed to do so). It will inform the coordinator or beneficiary concerned of the identity of the external persons or bodies. They have the right to object to the appointment on grounds of commercial confidentiality.

The coordinator or beneficiary concerned must provide — within the deadline requested — any information (including complete accounts, individual salary statements or other personal data) to verify compliance with the Agreement. The JU or the Commission may request beneficiaries to provide such information to it directly

For **on-the-spot** audits, the beneficiaries must allow access to their sites and premises, including to external persons or bodies, and must ensure that information requested is readily available.

Information provided must be accurate, precise and complete and in the format requested, including electronic format.

On the basis of the audit findings, a '**draft audit report**' will be drawn up.

The JU or the Commission will formally notify the draft audit report to the coordinator or beneficiary concerned, which has 30 days to formally notify observations ('contradictory audit procedure'). This period may be extended by the JU or the Commission in justified cases.

The '**final audit report**' will take into account observations by the coordinator or beneficiary concerned. The report will be formally notified to it.

Audits (including audit reports) are in the language of the Agreement.

The JU or the Commission may also access the beneficiaries' statutory records for the periodical assessment of unit costs or flat-rate amounts.

22.2 Investigations by the European Anti-Fraud Office (OLAF)

Under Regulations No 883/2013¹⁶ and No 2185/96¹⁷ (and in accordance with their provisions and procedures), and Article 49 of the JU Financial Rules, the European Anti-Fraud Office (OLAF) may — at any moment during implementation of the action or afterwards — carry out investigations, including on-the-spot checks and inspections, to establish whether there has been fraud, corruption or any other illegal activity affecting the financial interests of the EU.

22.3 Checks and audits by the European Court of Auditors (ECA)

Under Article 287 of the Treaty on the Functioning of the European Union (TFEU) and Article 49 of the Financial Rules of the JU, the European Court of Auditors (ECA) may — at any moment during implementation of the action or afterwards — carry out audits.

¹⁶ Regulation (EU, Euratom) No 883/2013 of the European Parliament and of the Council of 11 September 2013 concerning investigations conducted by the European Anti-Fraud Office (OLAF) and repealing Regulation (EC) No 1073/1999 of the European Parliament and of the Council and Council Regulation (Euratom) No 1074/1999 (OJ L 248, 18.09.2013, p. 1).

¹⁷ Council Regulation (Euratom, EC) No 2185/1996 of 11 November 1996 concerning on-the-spot checks and inspections carried out by the Commission in order to protect the European Communities' financial interests against fraud and other irregularities (OJ L 292, 15.11.1996, p. 2).

The ECA has the right of access for the purpose of checks and audits.

22.4 Checks, reviews, audits and investigations for international organisations

Not applicable

22.5 Consequences of findings in checks, reviews, audits and investigations —Extension of findings

22.5.1 Findings in this grant

Findings in checks, reviews, audits or investigations carried out in the context of this grant may lead to the rejection of ineligible costs (see Article 42), reduction of the grant (see Article 43), recovery of undue amounts (see Article 44) or to any of the other measures described in Chapter 6.

Rejection of costs or reduction of the grant after the payment of the balance will lead to a revised final grant amount (see Article 5.4).

Findings in checks, reviews, audits or investigations may lead to a request for amendment for the modification of Annex 1 (see Article 55).

Checks, reviews, audits or investigations that find systemic or recurrent errors, irregularities, fraud or breach of obligations may also lead to consequences in other JU, EU or Euratom grants awarded under similar conditions (**‘extension of findings from this grant to other grants’**).

Moreover, findings arising from an OLAF investigation may lead to criminal prosecution under national law.

22.5.2 Findings in other grants

The JU or the Commission may extend findings from other grants to this grant (**‘extension of findings from other grants to this grant’**), if:

- (a) the beneficiary concerned is found, in other JU, EU or Euratom grants awarded under similar conditions, to have committed systemic or recurrent errors, irregularities, fraud or breach of obligations that have a material impact on this grant and
- (b) those findings are formally notified to the beneficiary concerned — together with the list of grants affected by the findings — no later than two years after the payment of the balance of this grant.

The extension of findings may lead to the rejection of costs (see Article 42), reduction of the grant (see Article 43), recovery of undue amounts (see Article 44), suspension of payments (see Article 48), suspension of the action implementation (see Article 49) or termination (see Article 50).

22.5.3 Procedure

The JU or the Commission will formally notify the beneficiary concerned the systemic or recurrent errors and its intention to extend these audit findings, together with the list of grants affected.

22.5.3.1 If the findings concern **eligibility of costs**: the formal notification will include:

- (a) an invitation to submit observations on the list of grants affected by the findings;
- (b) the request to submit **revised financial statements** for all grants affected;
- (c) the **correction rate for extrapolation** established by the JU or the Commission on the basis of the systemic or recurrent errors, to calculate the amounts to be rejected if the beneficiary concerned:
 - (i) considers that the submission of revised financial statements is not possible or practicable or
 - (ii) does not submit revised financial statements.

The beneficiary concerned has 90 days from receiving notification to submit observations, revised financial statements or to propose a duly substantiated **alternative correction method**. This period may be extended by the JU or the Commission in justified cases.

The amounts to be rejected will be determined on the basis of the revised financial statements, subject to their approval.

If the JU or the Commission does not receive any observations or revised financial statements, does not accept the observations or the proposed alternative correction method or does not approve the revised financial statements, it will formally notify the beneficiary concerned the application of the initially notified correction rate for extrapolation.

If the JU or the Commission accepts the alternative correction method proposed by the beneficiary concerned, it will formally notify the application of the accepted alternative correction method.

22.5.3.2 If the findings concern **improper implementation** or a **breach of another obligation**: the formal notification will include:

- (a) an invitation to submit observations on the list of grants affected by the findings and
- (b) the flat-rate the JU or the Commission intends to apply according to the principle of proportionality.

The beneficiary concerned has 90 days from receiving notification to submit observations or to propose a duly substantiated alternative flat-rate.

If the JU or the Commission does not receive any observations or does not accept the observations or the proposed alternative flat-rate, it will formally notify the beneficiary concerned the application of the initially notified flat-rate.

If the JU or the Commission accepts the alternative flat-rate proposed by the beneficiary concerned, it will formally notify the application of the accepted alternative flat-rate.

22.6 Consequences of non-compliance

If a beneficiary breaches any of its obligations under this Article, any insufficiently substantiated costs will be ineligible (see Article 6) and will be rejected (see Article 42).

Such breaches may also lead to any of the other measures described in Chapter 6.

ARTICLE 23 — EVALUATION OF THE IMPACT OF THE ACTION

23.1 Right to evaluate the impact of the action

The JU or the Commission may carry out interim and final evaluations of the impact of the action measured against the objective of the EU programme.

Evaluations may be started during implementation of the action and up to *five* years after the payment of the balance. The evaluation is considered to start on the date of the formal notification to the coordinator or beneficiaries.

The JU or the Commission may make these evaluations directly (using its own staff) or indirectly (using external bodies or persons it has authorised to do so).

The coordinator or beneficiaries must provide any information relevant to evaluate the impact of the action, including information in electronic format.

23.2 Consequences of non-compliance

If a beneficiary breaches any of its obligations under this Article, the JU may apply the measures described in Chapter 6.

SECTION 3 RIGHTS AND OBLIGATIONS RELATED TO BACKGROUND AND RESULTS

SUBSECTION 1 GENERAL

ARTICLE 23a — MANAGEMENT OF INTELLECTUAL PROPERTY

23a.1 Obligation to take measures to implement the Commission Recommendation on the management of intellectual property in knowledge transfer activities

Beneficiaries that are universities or other public research organisations must take measures to implement the principles set out in Points 1 and 2 of the Code of Practice annexed to the Commission Recommendation on the management of intellectual property in knowledge transfer activities¹⁹.

This does not change the obligations set out in Subsections 2 and 3 of this Section.

The beneficiaries must ensure that researchers and third parties involved in the action are aware of them.

23a.2 Consequences of non-compliance

If a beneficiary breaches its obligations under this Article, the JU may apply any of the measures described in Chapter 6.

SUBSECTION 2 RIGHTS AND OBLIGATIONS RELATED TO BACKGROUND

¹⁹ Commission Recommendation C (2008) 1329 of 10.4.2008 on the management of intellectual property in knowledge transfer activities and the Code of Practice for universities and other public research institutions attached to this recommendation.

ARTICLE 24 — AGREEMENT ON BACKGROUND

24.1 Agreement on background

The beneficiaries must identify and agree (in writing) on the background for the action (**‘agreement on background’**).

‘Background’ means any data, know-how or information — whatever its form or nature (tangible or intangible), including any rights such as intellectual property rights — that:

- (a) is held by the beneficiaries before they acceded to the Agreement, and
- (b) is needed to implement the action or exploit the results.

24.2 Consequences of non-compliance

If a beneficiary breaches any of its obligations under this Article, the grant may be reduced (see Article 43).

Such breaches may also lead to any of the other measures described in Chapter 6.

ARTICLE 25 — ACCESS RIGHTS TO BACKGROUND

25.1 Exercise of access rights — Waiving of access rights — No sub-licensing

To exercise access rights, this must first be requested in writing (**‘request for access’**).

‘Access rights’ means rights to use results or background under the terms and conditions laid down in this Agreement.

Waivers of access rights are not valid unless in writing.

Unless agreed otherwise, access rights do not include the right to sub-license.

25.2 Access rights for other beneficiaries, for implementing their own tasks under the action

The beneficiaries must give each other access — on a royalty-free basis — to background needed to implement their own tasks under the action, unless the beneficiary that holds the background has — before acceding to the Agreement —:

- (a) informed the other beneficiaries that access to its background is subject to legal restrictions or limits, including those imposed by the rights of third parties (including personnel), or
- (b) agreed with the other beneficiaries that access would not be on a royalty-free basis.

25.3 Access rights for other beneficiaries, for exploiting their own results

The beneficiaries must give each other access — under fair and reasonable conditions — to background needed for exploiting their own results, unless the beneficiary that holds the background has — before acceding to the Agreement — informed the other beneficiaries that access to its background is subject to legal restrictions or limits, including those imposed by the rights of third parties (including personnel).

‘**Fair and reasonable conditions**’ means appropriate conditions, including possible financial terms or royalty-free conditions, taking into account the specific circumstances of the request for access, for example the actual or potential value of the results or background to which access is requested and/or the scope, duration or other characteristics of the exploitation envisaged.

Requests for access may be made — unless agreed otherwise — up to one year after the period set out in Article 3.

25.4 Access rights for affiliated entities

Unless otherwise agreed in the consortium agreement, access to background must also be given — under fair and reasonable conditions (see above; Article 25.3) and unless it is subject to legal restrictions or limits, including those imposed by the rights of third parties (including personnel) — to affiliated entities²⁰ established in an EU Member State or ‘**associated country**’²¹, if this is needed to exploit the results generated by the beneficiaries to which they are affiliated.

Unless agreed otherwise (see above; Article 25.1), the affiliated entity concerned must make the request directly to the beneficiary that holds the background.

Requests for access may be made — unless agreed otherwise — up to one year after the period set out in Article 3.

25.5 Access rights for third parties

Not applicable

25.6 Consequences of non-compliance

If a beneficiary breaches any of its obligations under this Article, the grant may be reduced (see Article 43).

Such breaches may also lead to any of the other measures described in Chapter 6.

SUBSECTION 3 RIGHTS AND OBLIGATIONS RELATED TO RESULTS

ARTICLE 26 — OWNERSHIP OF RESULTS

26.1 Ownership by the beneficiary that generates the results

Results are owned by the beneficiary that generates them.

‘**Results**’ means any (tangible or intangible) output of the action such as data, knowledge or information — whatever its form or nature, whether it can be protected or not — that is generated in the action, as well as any rights attached to it, including intellectual property rights.

²⁰ For the definition, see ‘affiliated entity’ footnote (Article 14.1).

²¹ For the definition, see Article 2.1(3) of the Rules for Participation Regulation No 1290/2013: ‘**associated country**’ means a third country which is party to an international agreement with the Union, as identified in *Article 7 of Horizon 2020 Framework Programme Regulation No 1291/2013. Article 7 sets out the conditions for association of non-EU countries to Horizon 2020.*

26.2 Joint ownership by several beneficiaries

Two or more beneficiaries own results jointly if:

- (a) they have jointly generated them and
- (b) it is not possible to:
 - (i) establish the respective contribution of each beneficiary, or
 - (ii) separate them for the purpose of applying for, obtaining or maintaining their protection (see Article 27).

The joint owners must agree (in writing) on the allocation and terms of exercise of their joint ownership (**‘joint ownership agreement’**), to ensure compliance with their obligations under this Agreement.

Unless otherwise agreed in the joint ownership agreement, each joint owner may grant non-exclusive licences to third parties to exploit jointly-owned results (without any right to sub-license), if the other joint owners are given:

- (a) at least 45 days advance notice and
- (b) fair and reasonable compensation.

Once the results have been generated, joint owners may agree (in writing) to apply another regime than joint ownership (such as, for instance, transfer to a single owner (see Article 30) with access rights for the others).

26.3 Rights of third parties (including personnel)

If third parties (including personnel) may claim rights to the results, the beneficiary concerned must ensure that it complies with its obligations under the Agreement.

If a third party generates results, the beneficiary concerned must obtain all necessary rights (transfer, licences or other) from the third party, in order to be able to respect its obligations as if those results were generated by the beneficiary itself.

If obtaining the rights is impossible, the beneficiary must refrain from using the third party to generate the results.

26.4 JU ownership, to protect results

26.4.1 The JU may — with the consent of the beneficiary concerned — assume ownership of results to protect them, if a beneficiary intends — up to four years after the period set out in Article 3 — to disseminate its results without protecting them, except in any of the following cases:

- (a) the lack of protection is because protecting the results is not possible, reasonable or justified (given the circumstances);
- (b) the lack of protection is because there is a lack of potential for commercial or industrial exploitation, or

- (c) the beneficiary intends to transfer the results to another beneficiary or third party established in an EU Member State or associated country, which will protect them.

Before the results are disseminated and unless any of the cases above under Points (a), (b) or (c) applies, the beneficiary must formally notify the JU and at the same time inform it of any reasons for refusing consent. The beneficiary may refuse consent only if it can show that its legitimate interests would suffer significant harm.

If the JU decides to assume ownership, it will formally notify the beneficiary concerned within 45 days of receiving notification.

No dissemination relating to these results may before the end of this period or, if the JU takes a positive decision, until it has taken the necessary steps to protect the results.

26.4.2 The JU may — with the consent of the beneficiary concerned — assume ownership of results to protect them, if a beneficiary intends — up to four years after the period set out in Article 3 — to stop protecting them or not to seek an extension of protection, except in any of the following cases:

- (a) the protection is stopped because of a lack of potential for commercial or industrial exploitation;
- (b) an extension would not be justified given the circumstances.

A beneficiary that intends to stop protecting results or not seek an extension must — unless any of the cases above under Points (a) or (b) applies — formally notify the JU at least 60 days before the protection lapses or its extension is no longer possible and at the same time inform it of any reasons for refusing consent. The beneficiary may refuse consent only if it can show that its legitimate interests would suffer significant harm.

If the JU decides to assume ownership, it will formally notify the beneficiary concerned within 45 days of receiving notification.

26.5 Consequences of non-compliance

If a beneficiary breaches any of its obligations under this Article, the grant may be reduced (see Article 43).

Such breaches may also lead to the any of the other measures described in Chapter 6.

ARTICLE 27 — PROTECTION OF RESULTS — VISIBILITY OF SUPPORT

27.1 Obligation to protect the results

Each beneficiary must examine the possibility of protecting its results and must adequately protect them — for an appropriate period and with appropriate territorial coverage — if:

- (a) the results can reasonably be expected to be commercially or industrially exploited and
- (b) protecting them is possible, reasonable and justified (given the circumstances).

When deciding on protection, the beneficiary must consider its own legitimate interests and the legitimate interests (especially commercial) of the other beneficiaries.

27.2 JU ownership, to protect the results

If a beneficiary intends not to protect its results, to stop protecting them or not seek an extension of protection, the JU may — under certain conditions (see Article 26.4) — assume ownership to ensure their (continued) protection.

27.3 Information on funding from the JU and support from the EU and JU members

Applications for protection of results (including patent applications) filed by or on behalf of a beneficiary must — unless the JU requests or agrees otherwise or unless it is impossible — include the following:

“The project leading to this application has received funding from the Electronic Component Systems for European Leadership Joint Undertaking under grant agreement No 737483. This Joint Undertaking receives support from the European Union’s Horizon 2020 research and innovation programme and Italy, France, Czech Republic, Germany”.

27.4 Consequences of non-compliance

If a beneficiary breaches any of its obligations under this Article, the grant may be reduced (see Article 43).

Such a breach may also lead to any of the other measures described in Chapter 6.

ARTICLE 28 — EXPLOITATION OF RESULTS

28.1 Obligation to exploit the results

Each beneficiary must — up to four years after the period set out in Article 3 — take measures aiming to ensure ‘**exploitation**’ of its results (either directly or indirectly, in particular through transfer or licensing; see Article 30) by:

- (a) using them in further research activities (outside the action);
- (b) developing, creating or marketing a product or process;
- (c) creating and providing a service, or
- (d) using them in standardisation activities.

This does not change the security obligations in Article 37, which still apply.

28.2 Results that could contribute to European or international standards — Information on funding from the JU and support from the EU and JU members

If results are incorporated in a standard, the beneficiary concerned must — unless the JU requests or agrees otherwise or unless it is impossible — ask the standardisation body to include the following statement in (information related to) the standard:

“Results incorporated in this standard received funding from the Electronic Component Systems for European Leadership Joint Undertaking under grant agreement No 737483. This Joint Undertaking receives support from the European Union’s Horizon 2020 research and innovation programme and Italy, France, Czech Republic, Germany”.

28.3 Consequences of non-compliance

If a beneficiary breaches any of its obligations under this Article, the grant may be reduced in accordance with Article 43.

Such a breach may also lead to any of the other measures described in Chapter 6.

ARTICLE 29 — DISSEMINATION OF RESULTS — OPEN ACCESS — VISIBILITY OF SUPPORT

29.1 Obligation to disseminate results

Unless it goes against their legitimate interests, each beneficiary must — as soon as possible — ‘**disseminate**’ its results by disclosing them to the public by appropriate means (other than those resulting from protecting or exploiting the results), including in scientific publications (in any medium).

This does not change the obligation to protect results in Article 27, the confidentiality obligations in Article 36, the security obligations in Article 37 or the obligations to protect personal data in Article 39, all of which still apply.

A beneficiary that intends to disseminate its results must give advance notice to the other beneficiaries of — unless agreed otherwise — at least 45 days, together with sufficient information on the results it will disseminate.

Any other beneficiary may object within — unless agreed otherwise — 30 days of receiving notification, if it can show that its legitimate interests in relation to the results or background would be significantly harmed. In such cases, the dissemination may not take place unless appropriate steps are taken to safeguard these legitimate interests.

If a beneficiary intends not to protect its results, it may — under certain conditions (see Article 26.4.1) — need to formally notify the JU before dissemination takes place.

29.2 Open access to scientific publications

Each beneficiary must ensure open access (free of charge online access for any user) to all peer-reviewed scientific publications relating to its results.

In particular, it must:

- (a) as soon as possible and at the latest on publication, deposit a machine-readable electronic copy of the published version or final peer-reviewed manuscript accepted for publication in a repository for scientific publications;

Moreover, the beneficiary must aim to deposit at the same time the research data needed to validate the results presented in the deposited scientific publications.

- (b) ensure open access to the deposited publication — via the repository — at the latest:
 - (i) on publication, if an electronic version is available for free via the publisher, or

- (ii) within six months of publication (twelve months for publications in the social sciences and humanities) in any other case.
- (c) ensure open access — via the repository — to the bibliographic metadata that identify the deposited publication.

The bibliographic metadata must be in a standard format and must include all of the following:

- the terms “ECSEL”, “European Union (EU)” and “Horizon 2020”;
- the name of the action, acronym and grant number;
- the publication date, and length of embargo period if applicable, and
- a persistent identifier.

29.3 Open access to research data

Not applicable

29.4 Information on funding from the JU and support from the EU and JU members — Obligation and right to use the JU logo and the EU emblem

Unless the JU requests or agrees otherwise or unless it is impossible, any dissemination of results (in any form, including electronic) must:

- (a) display the JU logo;
- (b) display the EU emblem and
- (c) include the following text:

“This project has received funding from the Electronic Component Systems for European Leadership Joint Undertaking under grant agreement No 737483. This Joint Undertaking receives support from the European Union’s Horizon 2020 research and innovation programme and Italy, France, Czech Republic, Germany” .

When displayed together with another logo, the JU logo and the EU emblem must have appropriate prominence.

For the purposes of their obligations under this Article, the beneficiaries may use the JU logo and the EU emblem without first obtaining approval from the JU or the Commission.

This does not however give them the right to exclusive use.

Moreover, they may not appropriate the JU logo or the EU emblem or any similar trademark or logo, either by registration or by any other means.

29.5 Disclaimer excluding JU responsibility

Any dissemination of results must indicate that it reflects only the author's view and that the JU is not responsible for any use that may be made of the information it contains.

29.6 Consequences of non-compliance

If a beneficiary breaches any of its obligations under this Article, the grant may be reduced (see Article 43).

Such a breach may also lead to any of the other measures described in Chapter 6.

ARTICLE 30 — TRANSFER AND LICENSING OF RESULTS

30.1 Transfer of ownership

Each beneficiary may transfer ownership of its results.

It must however ensure that its obligations under Articles 26.2, 26.4, 27, 28, 29, 30 and 31 also apply to the new owner and that this owner has the obligation to pass them on in any subsequent transfer.

This does not change the security obligations in Article 37, which still apply.

Unless agreed otherwise (in writing) for specifically-identified third parties or unless impossible under applicable EU and national laws on mergers and acquisitions, a beneficiary that intends to transfer ownership of results must give at least 45 days advance notice (or less if agreed in writing) to the other beneficiaries that still have (or still may request) access rights to the results. This notification must include sufficient information on the new owner to enable any beneficiary concerned to assess the effects on its access rights.

Unless agreed otherwise (in writing) for specifically-identified third parties, any other beneficiary may object within 30 days of receiving notification (or less if agreed in writing), if it can show that the transfer would adversely affect its access rights. In this case, the transfer may not take place until agreement has been reached between the beneficiaries concerned.

30.2 Granting licenses

Each beneficiary may grant licences to its results (or otherwise give the right to exploit them), if:

- (a) this does not impede the rights under Article 31 and
- (b) *not applicable*.

In addition to Points (a) and (b), exclusive licences for results may be granted only if all the other beneficiaries concerned have waived their access rights (see Article 31.1).

This does not change the dissemination obligations in Article 29 or security obligations in Article 37, which still apply.

30.3 JU right to object to transfers or licensing

Not applicable

30.4 Consequences of non-compliance

If a beneficiary breaches any of its obligations under this Article, the grant may be reduced (see Article 43).

Such a breach may also lead to any of the other measures described in Chapter 6.

ARTICLE 31 — ACCESS RIGHTS TO RESULTS

31.1 Exercise of access rights — Waiving of access rights — No sub-licensing

The conditions set out in Article 25.1 apply.

The obligations set out in this Article do not change the security obligations in Article 37, which still apply.

31.2 Access rights for other beneficiaries, for implementing their own tasks under the action

The beneficiaries must give each other access — on a royalty-free basis — to results needed for implementing their own tasks under the action.

31.3 Access rights for other beneficiaries, for exploiting their own results

The beneficiaries must give each other — under fair and reasonable conditions (see Article 25.3) — access to results needed for exploiting their own results.

Requests for access may be made — unless agreed otherwise — up to one year after the period set out in Article 3.

31.4 Access rights of affiliated entities

Unless agreed otherwise in the consortium agreement, access to results must also be given — under fair and reasonable conditions (Article 25.3) — to affiliated entities established in an EU Member State or associated country, if this is needed for those entities to exploit the results generated by the beneficiaries to which they are affiliated.

Unless agreed otherwise (see above; Article 31.1), the affiliated entity concerned must make any such request directly to the beneficiary that owns the results.

Requests for access may be made — unless agreed otherwise — up to one year after the period set out in Article 3.

31.5 Access rights for the JU, EU institutions, bodies, offices or agencies and EU Member States

The beneficiaries must give access to their results — on a royalty-free basis — to EU institutions, bodies, offices or agencies, for developing, implementing or monitoring EU policies or programmes.

Such access rights are limited to non-commercial and non-competitive use.

This does not change the right to use any material, document or information received from the beneficiaries for communication and publicising activities (see Article 38.2).

31.6 Access rights for third parties

Not applicable

31.7 Consequences of non-compliance

If a beneficiary breaches any of its obligations under this Article, the grant may be reduced (see Article 43).

Such breaches may also lead to any of the other measures described in Chapter 6.

SECTION 4 OTHER RIGHTS AND OBLIGATIONS

ARTICLE 32 — RECRUITMENT AND WORKING CONDITIONS FOR RESEARCHERS

32.1 Obligation to take measures to implement the European Charter for Researchers and Code of Conduct for the Recruitment of Researchers

The beneficiaries must take all measures to implement the principles set out in the Commission Recommendation on the European Charter for Researchers and the Code of Conduct for the Recruitment of Researchers²³, in particular regarding:

- working conditions;
- transparent recruitment processes based on merit, and
- career development.

The beneficiaries must ensure that researchers and third parties involved in the action are aware of them.

32.2 Consequences of non-compliance

If a beneficiary breaches its obligations under this Article, the JU may apply any of the measures described in Chapter 6.

ARTICLE 33 — GENDER EQUALITY

33.1 Obligation to aim for gender equality

The beneficiaries must take all measures to promote equal opportunities between men and women in the implementation of the action. They must aim, to the extent possible, for a gender balance at all levels of personnel assigned to the action, including at supervisory and managerial level.

33.2 Consequences of non-compliance

If a beneficiary breaches its obligations under this Article, the JU may apply any of the measures described in Chapter 6.

ARTICLE 34 — ETHICS

²³ Commission Recommendation 2005/251/EC of 11 March 2005 on the European Charter for Researchers and on a Code of Conduct for the Recruitment of Researchers (OJ L 75, 22.3.2005, p. 67).

34.1 Obligation to comply with ethical principles

The beneficiaries must carry out the action in compliance with:

- (a) ethical principles (including the highest standards of research integrity — as set out, for instance, in the European Code of Conduct for Research Integrity²⁴ — and including, in particular, avoiding fabrication, falsification, plagiarism or other research misconduct) and
- (b) applicable international, EU and national law.

Funding will not be granted for activities carried out outside the EU if they are prohibited in all Member States.

The beneficiaries must ensure that the activities under the action have an exclusive focus on civil applications.

The beneficiaries must ensure that the activities under the action do not:

- (a) aim at human cloning for reproductive purposes;
- (b) intend to modify the genetic heritage of human beings which could make such changes heritable (with the exception of research relating to cancer treatment of the gonads, which may be financed), or
- (c) intend to create human embryos solely for the purpose of research or for the purpose of stem cell procurement, including by means of somatic cell nuclear transfer.

34.2 Activities raising ethical issues

Activities raising ethical issues must comply with the ‘**ethics requirements**’ set out in Annex 1.

Before the beginning of an activity raising an ethical issue, the coordinator must submit (see Article 52) to the JU copy of:

- (a) any ethics committee opinion required under national law and
- (b) any notification or authorisation for activities raising ethical issues required under national law.

If these documents are not in English, the coordinator must also submit an English summary of the submitted opinions, notifications and authorisations (containing, if available, the conclusions of the committee or authority concerned).

If these documents are specifically requested for the action, the request must contain an explicit reference to the action title. The coordinator must submit a declaration by each beneficiary concerned that all the submitted documents cover the action tasks.

²⁴ The European Code of Conduct for Research Integrity of ALLEA (All European Academies) and ESF (European Science Foundation) of March 2011.

http://ec.europa.eu/research/participants/data/ref/h2020/other/hi/h2020-ethics_code-of-conduct_en.pdf

34.3 Activities involving human embryos or human embryonic stem cells

Activities involving research on human embryos or human embryonic stem cells may be carried out only if:

- they are set out in Annex 1 or
- the coordinator has obtained explicit approval (in writing) from the JU (see Article 52).

34.4 Consequences of non-compliance

If a beneficiary breaches any of its obligations under this Article, the grant may be reduced (see Article 43) and the Agreement or participation of the beneficiary may be terminated (see Article 50).

Such breaches may also lead to any of the other measures described in Chapter 6.

ARTICLE 35 — CONFLICT OF INTERESTS

35.1 Obligation to avoid a conflict of interests

The beneficiaries must take all measures to prevent any situation where the impartial and objective implementation of the action is compromised for reasons involving economic interest, political or national affinity, family or emotional ties or any other shared interest (**‘conflict of interests’**).

They must formally notify to the JU without delay any situation constituting or likely to lead to a conflict of interests and immediately take all the necessary steps to rectify this situation.

The JU may verify that the measures taken are appropriate and may require additional measures to be taken by a specified deadline.

35.2 Consequences of non-compliance

If a beneficiary breaches any of its obligations under this Article, the grant may be reduced (see Article 43) and the Agreement or participation of the beneficiary may be terminated (see Article 50).

Such breaches may also lead to any of the other measures described in Chapter 6.

ARTICLE 36 — CONFIDENTIALITY

36.1 General obligation to maintain confidentiality

During implementation of the action and for four years after the period set out in Article 3, the parties must keep confidential any data, documents or other material (in any form) that is identified as confidential at the time it is disclosed (**‘confidential information’**).

If a beneficiary requests, the JU may agree to keep such information confidential for an additional period beyond the initial four years.

If information has been identified as confidential only orally, it will be considered to be confidential only if this is confirmed in writing within 15 days of the oral disclosure.

Unless otherwise agreed between the parties, they may use confidential information only to implement the Agreement.

The beneficiaries may disclose confidential information to their personnel or third parties involved in the action only if they:

- (a) need to know to implement the Agreement and
- (b) are bound by an obligation of confidentiality.

This does not change the security obligations in Article 37, which still apply.

The JU may disclose confidential information to its staff, other EU institutions and bodies or third parties, if:

- (a) this is necessary to implement the Agreement or safeguard the EU's or JU's financial interests and
- (b) the recipients of the information are bound by an obligation of confidentiality.

The confidentiality obligations no longer apply if:

- (a) the disclosing party agrees to release the other party;
- (b) the information was already known by the recipient or is given to him without obligation of confidentiality by a third party that was not bound by any obligation of confidentiality;
- (c) the recipient proves that the information was developed without the use of confidential information;
- (d) the information becomes generally and publicly available, without breaching any confidentiality obligation, or
- (e) the disclosure of the information is required by EU or national law.

36.2 Consequences of non-compliance

If a beneficiary breaches any of its obligations under this Article, the grant may be reduced (see Article 43).

Such breaches may also lead to any of the other measures described in Chapter 6.

ARTICLE 37 — SECURITY-RELATED OBLIGATIONS

37.1 Results with a security recommendation

Not applicable

37.2 Classified results

Not applicable

37.3 Activities involving dual-use goods or dangerous materials and substances

Not applicable

37.4 Consequences of non-compliance

Not applicable

ARTICLE 38 — PROMOTING THE ACTION — VISIBILITY OF SUPPORT

38.1 Communication activities by beneficiaries

38.1.1 Obligation to promote the action and its results

The beneficiaries must promote the action and its results, by providing targeted information to multiple audiences (including the media and the public) in a strategic and effective manner.

This does not change the dissemination obligations in Article 29, the confidentiality obligations in Article 36 or the security obligations in Article 37, all of which still apply.

Before engaging in a communication activity expected to have a major media impact, the beneficiaries must inform the JU (see Article 52).

38.1.2 Information on funding from the JU and support from the EU and JU members — Obligation and right to use the JU logo and the EU emblem

Unless the JU requests or agrees otherwise or unless it is impossible, any communication activity related to the action (including in electronic form, via social media, etc.) and any infrastructure, equipment and major results funded by the grant must:

- (a) display the JU logo;
- (b) display the EU emblem and
- (c) include the following text:

For communication activities: “This project has received funding from the ECSEL Joint Undertaking under grant agreement No 737483. This Joint Undertaking receives support from the European Union’s Horizon 2020 research and innovation programme and Italy, France, Czech Republic, Germany” .

For infrastructure, equipment and major results: “This [infrastructure][equipment][insert type of result] is part of a project that has received funding from the ECSEL Joint Undertaking under grant agreement No 737483. This Joint Undertaking receives support from the European Union’s Horizon 2020 research and innovation programme and Italy, France, Czech Republic, Germany” .

When displayed together with another logo, the JU logo and the EU emblem must have appropriate prominence.

For the purposes of their obligations under this Article, the beneficiaries may use the JU logo and the EU emblem without first obtaining approval from the JU or the Commission.

This does not, however, give them the right to exclusive use.

Moreover, they may not appropriate the JU logo or the EU emblem or any similar trademark or logo, either by registration or by any other means.

38.1.3 Disclaimer excluding JU responsibility

Any communication activity related to the action must indicate that it reflects only the author's view and that the JU is not responsible for any use that may be made of the information it contains.

38.2 Communication activities by the JU

38.2.1 Right to use beneficiaries' materials, documents or information

The JU may use, for its communication and publicising activities, information relating to the action, documents notably summaries for publication and public deliverables as well as any other material, such as pictures or audio-visual material that it receives from any beneficiary (including in electronic form).

This does not change the confidentiality obligations in Article 36 and the security obligations in Article 37, all of which still apply.

However, if the JU's use of these materials, documents or information would risk compromising legitimate interests, the beneficiary concerned may request the JU not to use it (see Article 52).

The right to use a beneficiary's materials, documents and information includes:

- (a) **use for its own purposes** (in particular, making them available to persons working for the JU or any other EU institution, body, office or agency or body or institutions in EU Member States; and copying or reproducing them in whole or in part, in unlimited numbers);
- (b) **distribution to the public** (in particular, publication as hard copies and in electronic or digital format, publication on the internet, as a downloadable or non-downloadable file, broadcasting by any channel, public display or presentation, communicating through press information services, or inclusion in widely accessible databases or indexes);
- (c) **editing or redrafting** for communication and publicising activities (including shortening, summarising, inserting other elements (such as meta-data, legends, other graphic, visual, audio or text elements), extracting parts (e.g. audio or video files), dividing into parts, use in a compilation);
- (d) **translation**;
- (e) **giving access in response to individual requests** under Regulation No 1049/2001²⁵, without the right to reproduce or exploit;
- (f) **storage** in paper, electronic or other form;
- (g) **archiving**, in line with applicable document-management rules, and

²⁵ Regulation (EC) No 1049/2001 of the European Parliament and of the Council of 30 May 2001 regarding public access to European Parliament, Council and Commission documents, OJ L 145, 31.5.2001, p. 43.

(h) the right to authorise **third parties** to act on its behalf or sub-license the modes of use set out in Points (b),(c),(d) and (f) to third parties if needed for the communication and publicising activities of the JU.

If the right of use is subject to rights of a third party (including personnel of the beneficiary), the beneficiary must ensure that it complies with its obligations under this Agreement (in particular, by obtaining the necessary approval from the third parties concerned).

Where applicable (and if provided by the beneficiaries), the JU will insert the following information:

“© – [year] – [name of the copyright owner]. All rights reserved. Licensed to the ECSEL Joint Undertaking under conditions.”

38.3 Consequences of non-compliance

If a beneficiary breaches any of its obligations under this Article, the grant may be reduced (see Article 43).

Such breaches may also lead to any of the other measures described in Chapter 6.

ARTICLE 39 — PROCESSING OF PERSONAL DATA

39.1 Processing of personal data by the JU and the Commission

Any personal data under the Agreement will be processed by the JU or the Commission under Regulation No 45/2001²⁶ and according to the ‘notifications of the processing operations’ to the Data Protection Officer (DPO) of the JU or the Commission (publicly accessible in the DPO register).

Such data will be processed by the ‘**data controller**’ of the JU or the Commission for the purposes of implementing, managing and monitoring the Agreement or protecting the financial interests of the JU, EU or Euratom (including checks, reviews, audits and investigations; see Article 22).

The persons whose personal data are processed have the right to access and correct their own personal data. For this purpose, they must send any queries about the processing of their personal data to the data controller, via the contact point indicated in the ‘privacy statement’ that are published on the JU and the Commission websites.

They also have the right to have recourse at any time to the European Data Protection Supervisor (EDPS).

39.2 Processing of personal data by the beneficiaries

The beneficiaries must process personal data under the Agreement in compliance with applicable EU and national law on data protection (including authorisations or notification requirements).

The beneficiaries may grant their personnel access only to data that is strictly necessary for implementing, managing and monitoring the Agreement.

²⁶ Regulation (EC) No 45/2001 of the European Parliament and of the Council of 18 December 2000 on the protection of individuals with regard to the processing of personal data by the Community institutions and bodies and on the free movement of such data (OJ L 8, 12.01.2001, p. 1).

The beneficiaries must inform the personnel whose personal data are collected and processed by the JU or the Commission. For this purpose, they must provide them with the privacy statement (see above), before transmitting their data to the JU or the Commission.

39.3 Consequences of non-compliance

If a beneficiary breaches any of its obligations under Article 39.2, the JU may apply any of the measures described in Chapter 6.

ARTICLE 40 — ASSIGNMENTS OF CLAIMS FOR PAYMENT AGAINST THE JU

The beneficiaries may not assign any of their claims for payment against the JU to any third party, except if approved by the JU on the basis of a reasoned, written request by the coordinator (on behalf of the beneficiary concerned).

If the JU has not accepted the assignment or the terms of it are not observed, the assignment will have no effect on it.

In no circumstances will an assignment release the beneficiaries from their obligations towards the JU.

CHAPTER 5 DIVISION OF BENEFICIARIES' ROLES AND RESPONSIBILITIES — RELATIONSHIP WITH COMPLEMENTARY BENEFICIARIES — RELATIONSHIP WITH PARTNERS OF A JOINT ACTION

ARTICLE 41 — DIVISION OF BENEFICIARIES' ROLES AND RESPONSIBILITIES — RELATIONSHIP WITH COMPLEMENTARY BENEFICIARIES — RELATIONSHIP WITH PARTNERS OF A JOINT ACTION

41.1 Roles and responsibilities towards the JU

The beneficiaries have full responsibility for implementing the action and complying with the Agreement.

The beneficiaries are jointly and severally liable for the **technical implementation** of the action as described in Annex 1. If a beneficiary fails to implement its part of the action, the other beneficiaries become responsible for implementing this part (without being entitled to any additional JU funding for doing so), unless the JU expressly relieves them of this obligation.

The **financial responsibility** of each beneficiary is governed by Articles 44, 45 and 46.

41.2 Internal division of roles and responsibilities

The internal roles and responsibilities of the beneficiaries are divided as follows:

(a) Each **beneficiary** must:

- (i) keep information stored in the 'Beneficiary Register' (via the electronic exchange system) up to date (see Article 17);

(ii) inform the coordinator immediately of any events or circumstances likely to affect significantly or delay the implementation of the action (see Article 17);

(iii) submit to the coordinator in good time:

- individual financial statements for itself *and its linked third parties* and, if required, certificates on the financial statements (see Article 20);
- the data needed to draw up the technical reports (see Article 20);
- ethics committee opinions and notifications or authorisations for activities raising ethical issues (see Article 34);
- any other documents or information required by the JU under the Agreement, unless the Agreement requires the beneficiary to submit this information directly to the JU.

(b) The **coordinator** must:

- (i) monitor that the action is implemented properly (see Article 7);
- (ii) act as the intermediary for all communications between the beneficiaries and the JU (in particular, providing the JU with the information described in Article 17), unless the Agreement specifies otherwise;
- (iii) request and review any documents or information required by the JU and verify their completeness and correctness before passing them on to the JU;
- (iv) submit the deliverables and reports to the JU (see Articles 19 and 20);
- (v) ensure that all payments are made to the other beneficiaries without unjustified delay (see Article 21);
- (vi) inform the JU of the amounts paid to each beneficiary, when required under the Agreement (see Articles 44 and 50) or requested by the JU.

The coordinator may not delegate the above-mentioned tasks to any other beneficiary or subcontract them to any third party.

41.3 Internal arrangements between beneficiaries — Consortium agreement

The beneficiaries must have internal arrangements regarding their operation and co-ordination to ensure that the action is implemented properly. These internal arrangements must be set out in a written ‘consortium agreement’ between the beneficiaries, which may cover:

- *internal organisation of the consortium;*
- *management of access to the electronic exchange system;*
- *distribution of JU funding;*

- *additional rules on rights and obligations related to background and results (including whether access rights remain or not, if a beneficiary is in breach of its obligations) (see Section 3 of Chapter 4);*
- *settlement of internal disputes;*
- *liability, indemnification and confidentiality arrangements between the beneficiaries.*

The consortium agreement must not contain any provision contrary to the Agreement.

41.4 Relationship with complementary beneficiaries — Collaboration agreement

Not applicable

41.5 Relationship with partners of a joint action — Coordination agreement

Not applicable

CHAPTER 6 REJECTION OF COSTS — REDUCTION OF THE GRANT — RECOVERY — PENALTIES — DAMAGES — SUSPENSION — TERMINATION — FORCE MAJEURE

SECTION 1 REJECTION OF COSTS — REDUCTION OF THE GRANT — RECOVERY — PENALTIES

ARTICLE 42 — REJECTION OF INELIGIBLE COSTS

42.1 Conditions

42.1.1 The JU will — at the time of an **interim payment, at the payment of the balance or afterwards** — reject any costs which are ineligible (see Article 6), in particular following checks, reviews, audits or investigations (see Article 22).

42.1.2 The rejection may also be based on the **extension of findings from other grants to this grant**, under the conditions set out in Article 22.5.2.

42.2 Ineligible costs to be rejected — Calculation — Procedure

Ineligible costs will be rejected in full.

If the JU rejects costs **without reduction of the grant** (see Article 43) or **recovery of undue amounts** (see Article 44), it will formally notify the coordinator or beneficiary concerned the rejection of costs, the amounts and the reasons why (if applicable, together with the notification of amounts due; see Article 21.5). The coordinator or beneficiary concerned may — within 30 days of receiving notification — formally notify the JU of its disagreement and the reasons why.

If the JU rejects costs **with reduction of the grant** or **recovery of undue amounts**, it will formally notify the rejection in the ‘**pre-information letter**’ on reduction or recovery set out in Articles 43 and 44.

42.3 Effects

If the JU rejects costs at the time of an **interim payment** or **the payment of the balance**, it will deduct them from the total eligible costs declared, for the action, in the periodic or final summary financial statement (see Articles 20.3 and 20.4). It will then calculate the interim payment or payment of the balance as set out in Articles 21.3 or 21.4.

If the JU — **after an interim payment but before the payment of the balance** — rejects costs declared in a periodic summary financial statement, it will deduct them from the total eligible costs declared, for the action, in the next periodic summary financial statement or in the final summary financial statement. It will then calculate the interim payment or payment of the balance as set out in Articles 21.3 or 21.4.

If the JU rejects costs **after the payment of the balance**, it will deduct the amount rejected from the total eligible costs declared, by the beneficiary, in the final summary financial statement. It will then calculate the revised final grant amount as set out in Article 5.4.

ARTICLE 43 — REDUCTION OF THE GRANT

43.1 Conditions

43.1.1 The JU may — **at the payment of the balance** or **afterwards** — reduce the maximum grant amount (see Article 5.1), if the action has not been implemented properly as described in Annex 1 or another obligation under the Agreement has been breached.

43.1.2 The JU may also reduce the maximum grant amount on the basis of the **extension of findings from other grants to this grant**, under the conditions set out in Article 22.5.2.

43.2 Amount to be reduced — Calculation — Procedure

The amount of the reduction will be proportionate to the improper implementation of the action or to the seriousness of the breach.

Before reduction of the grant, the JU will formally notify a **‘pre-information letter’** to the coordinator or beneficiary concerned:

- informing it of its intention to reduce the grant, the amount it intends to reduce and the reasons why and
- inviting it to submit observations within 30 days of receiving notification

If the JU does not receive any observations or decides to pursue reduction despite the observations it has received, it will formally notify **confirmation** of the reduction (if applicable, together with the notification of amounts due; see Article 21).

43.3 Effects

If the JU reduces the grant at the time of **the payment of the balance**, it will calculate the reduced grant amount for the action and then determine the amount due as payment of the balance (see Articles 5.3.4 and 21.4).

If the JU reduces the grant **after the payment of the balance**, it will calculate the revised final grant amount for the beneficiary concerned (see Article 5.4). If the revised final grant amount for the beneficiary concerned is lower than its share of the final grant amount, the JU will recover the difference (see Article 44).

ARTICLE 44 — RECOVERY OF UNDUE AMOUNTS

44.1 Amount to be recovered — Calculation — Procedure

The JU will — after **termination of the participation of a beneficiary, at the payment of the balance or afterwards** — claim back any amount that was paid but is not due under the Agreement.

Each beneficiary's financial responsibility in case of recovery is limited to its own debt (*including undue amounts paid by the JU for costs declared by its linked third parties*), except for the amount retained for the Guarantee Fund (see Article 21.4).

44.1.1 Recovery after termination of a beneficiary's participation

If recovery takes place after termination of a beneficiary's participation (including the coordinator), the JU will claim back the undue amount from the beneficiary concerned, by formally notifying it a debit note (see Article 50.2 and 50.3). This note will specify the amount to be recovered, the terms and the date for payment.

If payment is not made by the date specified in the debit note, the JU will **recover** the amount:

- (a) by '**offsetting**' it — without the beneficiary's consent — against any amounts owed to the beneficiary concerned by the JU.

In exceptional circumstances, to safeguard the EU's or JU's financial interests, the JU may offset before the payment date specified in the debit note;

(b) *Not applicable;*

- (c) by **taking legal action** (see Article 57)

If payment is not made by the date specified in the debit note, the amount to be recovered (see above) will be increased by **late-payment interest** at the rate set out in Article 21.11, from the day following the payment date in the debit note, up to and including the date the JU receives full payment of the amount.

Partial payments will be first credited against expenses, charges and late-payment interest and then against the principal.

Bank charges incurred in the recovery process will be borne by the beneficiary, unless Directive 2007/64/EC²⁷ applies.

44.1.2 Recovery at payment of the balance

²⁷ Directive 2007/64/EC of the European Parliament and of the Council of 13 November 2007 on payment services in the internal market amending Directives 97/7/EC, 2002/65/EC, 2005/60/EC and 2006/48/EC and repealing Directive 97/5/EC (OJ L 319, 05.12.2007, p. 1).

If the payment of the balance takes the form of a recovery (see Article 21.4), the JU will formally notify a ‘**pre-information letter**’ to the coordinator:

- informing it of its intention to recover, the amount due as the balance and the reasons why;
- specifying that it intends to deduct the amount to be recovered from the amount retained for the Guarantee Fund;
- requesting the coordinator to submit a report on the distribution of payments to the beneficiaries within 30 days of receiving notification, and
- inviting the coordinator to submit observations within 30 days of receiving notification.

If no observations are submitted or the JU decides to pursue recovery despite the observations it has received, it will **confirm recovery** (together with the notification of amounts due; see Article 21.5) and:

- pay the difference between the amount to be recovered and the amount retained for the Guarantee Fund, **if the difference is positive** or
- formally notify to the coordinator a **debit note** for the difference between the amount to be recovered and the amount retained for the Guarantee Fund, **if the difference is negative**. This note will also specify the terms and the date for payment.

If the coordinator does not repay the JU by the date in the debit note and has not submitted the report on the distribution of payments: the JU will **recover** the amount set out in the debit note from the coordinator (see below).

If the coordinator does not repay the JU by the date in the debit note, but has submitted the report on the distribution of payments: the JU will:

- (a) identify the beneficiaries for which the amount calculated as follows is negative:

$\{ \{ \{ \text{beneficiary's costs declared in the final summary financial statement and approved by the JU multiplied by the reimbursement rate set out in Article 5.2 for the beneficiary concerned} \} \}$

plus

its linked third parties' costs declared in the final summary financial statement and approved by the JU multiplied by the reimbursement rate set out in Article 5.2 for each linked third party concerned}

divided by

the JU contribution for the action calculated according to Article 5.3.1 }

multiplied by

the final grant amount (see Article 5.3)},

minus

{pre-financing and interim payments received by the beneficiary}}.

- (b) formally notify to each beneficiary identified according to point (a) a **debit note** specifying the terms and date for payment. The amount of the debit note is calculated as follows:

{ {amount calculated according to point (a) for the beneficiary concerned

divided by

the sum of the amounts calculated according to point (a) for all the beneficiaries identified according to point (a)}

multiplied by

the amount set out in the debit note formally notified to the coordinator}.

If payment is not made by the date specified in the debit note, the JU will **recover** the amount:

- (a) by '**offsetting**' it — without the beneficiary's consent — against any amounts owed to the beneficiary concerned by the JU.

In exceptional circumstances, to safeguard the EU's or JU's financial interests, the JU may offset before the payment date specified in the debit note;

- (b) by **drawing on the Guarantee Fund**. The JU will formally notify the beneficiary concerned the debit note on behalf of the Guarantee Fund and recover the amount:

(i) *not applicable*;

(ii) by **taking legal action** (see Article 57).

If payment is not made by the date in the debit note, the amount to be recovered (see above) will be increased by **late-payment interest** at the rate set out in Article 21.11, from the day following the payment date in the debit note, up to and including the date the JU receives full payment of the amount.

Partial payments will be first credited against expenses, charges and late-payment interest and then against the principal.

Bank charges incurred in the recovery process will be borne by the beneficiary, unless Directive 2007/64/EC applies.

44.1.3 Recovery of amounts after payment of the balance

If, for a beneficiary, the revised final grant amount (see Article 5.4) is lower than its share of the final grant amount, it must repay the difference to the JU.

The beneficiary's share of the final grant amount is calculated as follows:

{ { {beneficiary's costs declared in the final summary financial statement and approved by the JU multiplied by the reimbursement rate set out in Article 5.2 for the beneficiary concerned

plus

its linked third parties' costs declared in the final summary financial statement and approved by the JU multiplied by the reimbursement rate set out in Article 5.2 for each linked third party concerned}

divided by

the JU contribution for the action calculated according to Article 5.3.1 }

multiplied by

the final grant amount (see Article 5.3) }.

If the coordinator has not distributed amounts received (see Article 21.7), the JU will also recover these amounts.

The JU will formally notify a **pre-information letter** to the beneficiary concerned:

- informing it of its intention to recover, the due amount and the reasons why and
- inviting it to submit observations within 30 days of receiving notification.

If no observations are submitted or the JU decides to pursue recovery despite the observations it has received, it will **confirm** the amount to be recovered and formally notify to the beneficiary concerned a **debit note**. This note will also specify the terms and the date for payment.

If payment is not made by the date specified in the debit note, the JU will **recover** the amount:

- (a) by '**offsetting**' it — without the beneficiary's consent — against any amounts owed to the beneficiary concerned by the JU.

In exceptional circumstances, to safeguard the EU's or JU's financial interests, the JU may offset before the payment date specified in the debit note;

- (b) by **drawing on the Guarantee Fund**. The JU will formally notify the beneficiary concerned the debit note on behalf of the Guarantee Fund and recover the amount:

(i) *not applicable*;

(ii) by **taking legal action** (see Article 57).

If payment is not made by the date in the debit note, the amount to be recovered (see above) will be increased by **late-payment interest** at the rate set out in Article 21.11, from the day following the date for payment in the debit note, up to and including the date the JU receives full payment of the amount.

Partial payments will be first credited against expenses, charges and late-payment interest and then against the principal.

Bank charges incurred in the recovery process will be borne by the beneficiary, unless Directive 2007/64/EC applies.

ARTICLE 45 — ADMINISTRATIVE AND FINANCIAL PENALTIES

45.1 Conditions

Under Articles 33 and 35 of the Financial Rules of the JU (read in conjunction with Articles 109 and 131(4) of the Financial Regulation No 966/2012), the JU may impose **administrative** and **financial penalties** if a beneficiary:

- (a) has committed substantial errors, irregularities or fraud or is in serious breach of its obligations under the Agreement or
- (b) has made false declarations about information required under the Agreement or for the submission of the proposal (or has not supplied such information).

Each beneficiary is responsible for paying the financial penalties imposed on it.

Under Articles 33 and 35 of the Financial Rules of the JU (read in conjunction with Article 109(3) of the Financial Regulation No 966/2012), the JU may — under certain conditions and limits — publish decisions imposing administrative or financial penalties.

45.2 Duration — Amount of penalty — Calculation

Administrative penalties exclude the beneficiary from all JU contracts and grants for a maximum of five years from the date the infringement is established by the JU.

If the beneficiary commits another infringement within five years of the date the first infringement is established, the JU may extend the exclusion period up to 10 years.

Financial penalties will be between 2% and 10% of the maximum JU contribution indicated, for the beneficiary concerned, in the estimated budget (see Annex 2).

If the beneficiary commits another infringement within five years of the date the first infringement is established, the JU may increase the rate of financial penalties to between 4% and 20%.

45.3 Procedure

Before applying a penalty, the JU will formally notify the beneficiary concerned:

- informing it of its intention to impose a penalty, its duration or amount and the reasons why and
- inviting it to submit observations within 30 days.

If the JU does not receive any observations or decides to impose the penalty despite of observations it has received, it will formally notify **confirmation** of the penalty to the beneficiary concerned and — in case of financial penalties — deduct the penalty from the payment of the balance or formally notify a **debit note**, specifying the amount to be recovered, the terms and the date for payment.

If payment is not made by the date specified in the debit note, the JU may **recover** the amount:

- (a) by ‘**offsetting**’ it — without the beneficiary’s consent — against any amounts owed to the beneficiary concerned by the JU.

In exceptional circumstances, to safeguard the EU’s or JU’s financial interests, the JU may offset before the payment date in the debit note;

(b) by **taking legal action** (see Article 57).

If payment is not made by the date in the debit note, the amount to be recovered (see above) will be increased by **late-payment interest** at the rate set out in Article 21.11, from the day following the payment date in the debit note, up to and including the date the JU receives full payment of the amount.

Partial payments will be first credited against expenses, charges and late-payment interest and then against the principal.

Bank charges incurred in the recovery process will be borne by the beneficiary, unless Directive 2007/64/EC applies.

SECTION 2 LIABILITY FOR DAMAGES

ARTICLE 46 — LIABILITY FOR DAMAGES

46.1 Liability of the JU

The JU cannot be held liable for any damage caused to the beneficiaries or to third parties as a consequence of implementing the Agreement, including for gross negligence.

The JU cannot be held liable for any damage caused by any of the beneficiaries or third parties involved in the action, as a consequence of implementing the Agreement.

46.2 Liability of the beneficiaries

46.2.1 Conditions

Except in case of force majeure (see Article 51), the beneficiaries must compensate the JU for any damage it sustains as a result of the implementation of the action or because the action was not implemented in full compliance with the Agreement.

Each beneficiary is responsible for paying the damages claimed from it.

46.2.2 Amount of damages - Calculation

The amount the JU can claim from a beneficiary will correspond to the damage caused by that beneficiary.

46.2.3 Procedure

Before claiming damages, the JU will formally notify the beneficiary concerned:

- informing it of its intention to claim damages, the amount and the reasons why and
- inviting it to submit observations within 30 days.

If the JU does not receive any observations or decides to claim damages despite the observations it has received, it will formally notify **confirmation** of the claim for damages and a **debit note**, specifying the amount to be recovered, the terms and the date for payment.

If payment is not made by the date specified in the debit note, the JU may **recover** the amount:

- (a) by ‘**offsetting**’ it — without the beneficiary’s consent — against any amounts owed to the beneficiary concerned by the JU.

In exceptional circumstances, to safeguard the EU’s or JU’s financial interests, the JU may offset before the payment date specified in the debit note;

- (b) by **taking legal action** (see Article 57).

If payment is not made by the date in the debit note, the amount to be recovered (see above) will be increased by **late-payment interest** at the rate set out in Article 21.11, from the day following the payment date in the debit note, up to and including the date the JU receives full payment of the amount.

Partial payments will be first credited against expenses, charges and late-payment interest and then against the principal.

Bank charges incurred in the recovery process will be borne by the beneficiary, unless Directive 2007/64/EC applies.

SECTION 3 SUSPENSION AND TERMINATION

ARTICLE 47 — SUSPENSION OF PAYMENT DEADLINE

47.1 Conditions

The JU may — at any moment — suspend the payment deadline (see Article 21.2 to 21.4) if a request for payment (see Article 20) cannot be approved because:

- (a) it does not comply with the provisions of the Agreement (see Article 20);
- (b) the technical reports or financial reports have not been submitted or are not complete or additional information is needed, or
- (c) there is doubt about the eligibility of the costs declared in the financial statements and additional checks, reviews, audits or investigations are necessary.

47.2 Procedure

The JU will formally notify the coordinator of the suspension and the reasons why.

The suspension will **take effect** the day notification is sent by the JU (see Article 52).

If the conditions for suspending the payment deadline are no longer met, the suspension will be **lifted** — and the remaining period will resume.

If the suspension exceeds two months, the coordinator may request the JU if the suspension will continue.

If the payment deadline has been suspended due to the non-compliance of the technical or financial reports (see Article 20) and the revised report or statement is not submitted or was submitted but is

also rejected, the JU may also terminate the Agreement or the participation of the beneficiary (see Article 50.3.1(1)).

ARTICLE 48 — SUSPENSION OF PAYMENTS

48.1 Conditions

The JU may — at any moment — suspend, in whole or in part, the pre-financing payment and interim payments for one or more beneficiaries or the payment of the balance for all beneficiaries, if a beneficiary:

- (a) has committed or is suspected of having committed substantial errors, irregularities, fraud or serious breach of obligations in the award procedure or under this Agreement or
- (b) has committed — in other JU, EU or Euratom grants awarded to it under similar conditions — systemic or recurrent errors, irregularities, fraud or serious breach of obligations that have a material impact on this grant (**extension of findings from other grants to this grant**; see Article 22.5.2).

48.2 Procedure

Before suspending payments, the JU will formally notify the coordinator:

- informing it of its intention to suspend payments and the reasons why and
- inviting it to submit observations within 30 days of receiving notification.

If the JU does not receive observations or decides to pursue the procedure despite the observations it has received, it will formally notify **confirmation** of the suspension. Otherwise, it will formally notify that the suspension procedure is not continued.

The suspension will **take effect** the day the confirmation notification is sent by the JU.

If the conditions for resuming payments are met, the suspension will be **lifted**. The JU will formally notify the coordinator.

During the suspension, the periodic report(s) (see Article 20.3) must not contain any individual financial statements from the beneficiary concerned *and its linked third parties*. When the JU resumes payments, the coordinator may include them in the next periodic report.

The beneficiaries may suspend implementation of the action (see Article 49.1) or terminate the Agreement or the participation of the beneficiary concerned (see Article 50.1 and 50.2).

ARTICLE 49 — SUSPENSION OF THE ACTION IMPLEMENTATION

49.1 Suspension of the action implementation, by the beneficiaries

49.1.1 Conditions

The beneficiaries may suspend implementation of the action or any part of it, if exceptional circumstances — in particular *force majeure* (see Article 51) — make implementation impossible or excessively difficult.

49.1.2 Procedure

The coordinator must immediately formally notify to the JU the suspension (see Article 52), stating:

- the reasons why and
- the expected date of resumption.

The suspension will **take effect** the day this notification is received by the JU.

Once circumstances allow for implementation to resume, the coordinator must immediately formally notify the JU and request an **amendment** of the Agreement to set the date on which the action will be resumed, extend the duration of the action and make other changes necessary to adapt the action to the new situation (see Article 55) — unless the Agreement or the participation of a beneficiary has been terminated (see Article 50).

The suspension will be **lifted** with effect from the resumption date set out in the amendment. This date may be before the date on which the amendment enters into force.

Costs incurred during suspension of the action implementation are not eligible (see Article 6).

49.2 Suspension of the action implementation, by the JU

49.2.1 Conditions

The JU may suspend implementation of the action or any part of it:

- (a) if a beneficiary has committed or is suspected of having committed substantial errors, irregularities, fraud or serious breach of obligations in the award procedure or under this Agreement;
- (b) if a beneficiary has committed — in other JU, EU or Euratom grants awarded to it under similar conditions — systemic or recurrent errors, irregularities, fraud or serious breach of obligations that have a material impact on this grant (**extension of findings from other grants to this grant**; see Article 22.5.2), or
- (c) if the action is suspected of having lost its scientific or technological relevance.

49.2.2 Procedure

Before suspending implementation of the action, the JU will formally notify the coordinator:

- informing it of its intention to suspend the implementation and the reasons why and
- inviting it to submit observations within 30 days of receiving notification.

If the JU does not receive observations or decides to pursue the procedure despite the observations it has received, it will formally notify **confirmation** of the suspension. Otherwise, it will formally notify that the procedure is not continued.

The suspension will **take effect** five days after confirmation notification is received by the coordinator (or on a later date specified in the notification).

It will be **lifted** if the conditions for resuming implementation of the action are met.

The coordinator will be formally notified of the lifting and the Agreement will be **amended** to set the date on which the action will be resumed, extend the duration of the action and make other changes necessary to adapt the action to the new situation (see Article 55) — unless the Agreement has already been terminated (see Article 50).

The suspension will be lifted with effect from the resumption date set out in the amendment. This date may be before the date on which the amendment enters into force.

Costs incurred during suspension are not eligible (see Article 6).

The beneficiaries may not claim damages due to suspension by the JU (see Article 46).

Suspension of the action implementation does not affect the JU's right to terminate the Agreement or participation of a beneficiary (see Article 50), reduce the grant or recover amounts unduly paid (see Articles 43 and 44).

ARTICLE 50 — TERMINATION OF THE AGREEMENT OR OF THE PARTICIPATION OF ONE OR MORE BENEFICIARIES

50.1 Termination of the Agreement by the beneficiaries

50.1.1 Conditions and procedure

The beneficiaries may terminate the Agreement.

The coordinator must formally notify termination to the JU (see Article 52), stating:

- the reasons why and
- the date the termination will take effect. This date must be after the notification.

If no reasons are given or if the JU considers the reasons do not justify termination, the Agreement will be considered to have been '**terminated improperly**'.

The termination will **take effect** on the day specified in the notification.

50.1.2 Effects

The coordinator must — within 60 days from when termination takes effect — submit:

- (i) a periodic report (for the open reporting period until termination; see Article 20.3) and
- (ii) the final report (see Article 20.4).

If the JU does not receive the reports within the deadline (see above), only costs which are included in an approved periodic report will be taken into account.

The JU will **calculate** the final grant amount (see Article 5.3) and the balance (see Article 21.4) on the basis of the reports submitted. Only costs incurred until termination are eligible (see Article 6). Costs relating to contracts due for execution only after termination are not eligible.

Improper termination may lead to a reduction of the grant (see Article 43).

After termination, the beneficiaries' obligations (in particular Articles 20, 22, 23, Section 3 of Chapter 4, 36, 37, 38 and 40) continue to apply.

50.2 Termination of the participation of one or more beneficiaries, by the beneficiaries

50.2.1 Conditions and procedure

The participation of one or more beneficiaries may be terminated by the coordinator, on request of the beneficiary concerned or on behalf of the other beneficiaries.

The coordinator must formally notify termination to the JU (see Article 52) and inform the beneficiary concerned.

If the coordinator's participation is terminated without its agreement, the formal notification must be done by another beneficiary (acting on behalf of the other beneficiaries).

The notification must include:

- the reasons why;
- the opinion of the beneficiary concerned (or proof that this opinion has been requested in writing);
- the date the termination takes effect. This date must be after the notification, and
- a request for amendment (see Article 55), with a proposal for reallocation of the tasks and the estimated budget of the beneficiary concerned (see Annexes 1 and 2) and, if necessary, the addition of one or more new beneficiaries (see Article 56). If termination takes effect after the period set out in Article 3, no request for amendment must be included unless the beneficiary concerned is the coordinator. In this case, the request for amendment must propose a new coordinator.

If this information is not given or if the JU considers that the reasons do not justify termination, the participation will be considered to have been **terminated improperly**.

The termination will **take effect** on the day specified in the notification.

50.2.2 Effects

The coordinator must — within 30 days from when termination takes effect — submit:

- (i) a report on the distribution of payments to the beneficiary concerned and
- (ii) if termination takes effect during the period set out in Article 3, a '**termination report**' from the beneficiary concerned, for the open reporting period until termination, containing an overview of the progress of the work, an overview of the use of resources, the individual financial statement and, if applicable, the certificate on the financial statement (see Articles 20.3 and 20.4).

The information in the termination report must also be included in the periodic report for the next reporting period (see Article 20.3).

If the request for amendment is rejected by the JU, (because it calls into question the decision awarding the grant or breaches the principle of equal treatment of applicants), the Agreement may be terminated according to Article 50.3.1(c).

If the request for amendment is accepted by the JU, the Agreement is **amended** to introduce the necessary changes (see Article 55).

The JU will **calculate** — on the basis of the periodic reports, the termination report and the report on the distribution of payments — if the (pre-financing and interim) payments received by the beneficiary concerned exceed the beneficiary's JU contribution (calculated by applying the reimbursement rate(s) to the eligible costs declared by the beneficiary *and its linked third parties* and approved by the JU). Only costs incurred by the beneficiary concerned until termination takes effect are eligible (see Article 6). Costs relating to contracts due for execution only after termination are not eligible.

- If the payments received **exceed the amounts due**:
 - if termination takes effect during the period set out in Article 3 and the request for amendment is accepted, the beneficiary concerned must repay to the coordinator the amount unduly received. The JU will formally notify the amount unduly received and request the beneficiary concerned to repay it to the coordinator within 30 days of receiving notification. If it does not repay the coordinator, the JU will draw upon the Guarantee Fund to pay the coordinator and then notify a **debit note** on behalf of the Guarantee Fund to the beneficiary concerned (see Article 44);
 - in all other cases (in particular if termination takes effect after the period set out in Article 3), the JU will formally notify a **debit note** to the beneficiary concerned. If payment is not made by the date in the debit note, the Guarantee Fund will pay to the JU the amount due and the JU will notify a debit note on behalf of the Guarantee Fund to the beneficiary concerned (see Article 44);
 - if the beneficiary concerned is the former coordinator, it must repay the new coordinator according to the procedure above, unless:
 - termination is after an interim payment and
 - the former coordinator has not distributed amounts received as pre-financing or interim payments (see Article 21.7).

In this case, the JU will formally notify a **debit note** to the former coordinator. If payment is not made by the date in the debit note, the Guarantee Fund will pay to the JU the amount due. The JU will then pay the new coordinator and notify a debit note on behalf of the Guarantee Fund to the former coordinator (see Article 44).

- If the payments received **do not exceed the amounts due**: amounts owed to the beneficiary concerned will be included in the next interim or final payment.

If the JU does not receive the termination report within the deadline (see above), only costs included in an approved periodic report will be taken into account.

If the JU does not receive the report on the distribution of payments within the deadline (see above), it will consider that:

- the coordinator did not distribute any payment to the beneficiary concerned and that
- the beneficiary concerned must not repay any amount to the coordinator.

Improper termination may lead to a reduction of the grant (see Article 43) or termination of the Agreement (see Article 50).

After termination, the concerned beneficiary's obligations (in particular Articles 20, 22, 23, Section 3 of Chapter 4, 36, 37, 38 and 40) continue to apply.

50.3 Termination of the Agreement or the participation of one or more beneficiaries, by the JU

50.3.1 Conditions

The JU may terminate the Agreement or the participation of one or more beneficiaries, if:

- (a) one or more beneficiaries do not accede to the Agreement (see Article 56);
- (b) a change to their legal, financial, technical, organisational or ownership situation (*or those of its linked third parties*) is likely to substantially affect or delay the implementation of the action or calls into question the decision to award the grant;
- (c) following termination of participation for one or more beneficiaries (see above), the necessary changes to the Agreement would call into question the decision awarding the grant or breach the principle of equal treatment of applicants (see Article 55);
- (d) implementation of the action is prevented by force majeure (see Article 51) or suspended by the coordinator (see Article 49.1) and either:
 - (i) resumption is impossible, or
 - (ii) the necessary changes to the Agreement would call into question the decision awarding the grant or breach the principle of equal treatment of applicants;
- (e) a beneficiary is declared bankrupt, being wound up, having its affairs administered by the courts, has entered into an arrangement with creditors, has suspended business activities, or is subject to any other similar proceedings or procedures under national law;
- (f) a beneficiary (or a natural person who has the power to represent or take decisions on its behalf) has been found guilty of professional misconduct, proven by any means;
- (g) a beneficiary does not comply with the applicable national law on taxes and social security;
- (h) the action has lost scientific or technological relevance;
- (i) *not applicable*;
- (j) *not applicable*;

- (k) a beneficiary (or a natural person who has the power to represent or take decisions on its behalf) has committed fraud, corruption, or is involved in a criminal organisation, money laundering or any other illegal activity affecting the EU's or JU's financial interests;
- (l) a beneficiary (or a natural person who has the power to represent or take decisions on its behalf) has — in the award procedure or under the Agreement — committed:
 - (i) substantial errors, irregularities, fraud or
 - (ii) serious breach of obligations, including improper implementation of the action, submission of false information, failure to provide required information, breach of ethical principles;
- (m) a beneficiary has committed — in other JU, EU or Euratom grants awarded to it under similar conditions — systemic or recurrent errors, irregularities, fraud or serious breach of obligations that have a material impact on this grant ('**extension of findings from other grants to this grant**').

50.3.2 Procedure

Before terminating the Agreement or participation of one or more beneficiaries, the JU will formally notify the coordinator:

- informing it of its intention to terminate and the reasons why and
- inviting it, within 30 days of receiving notification, to submit observations and — in case of Point (l.ii) above — to inform the JU of the measures to ensure compliance with the obligations under the Agreement.

If the JU does not receive observations or decides to pursue the procedure despite the observations it has received, it will formally notify to the coordinator **confirmation** of the termination and the date it will take effect. Otherwise, it will formally notify that the procedure is not continued.

The termination will **take effect**:

- for terminations under Points (b), (c), (e), (g), (h), (j), and (l.ii) above: on the day specified in the notification of the confirmation (see above);
- for terminations under Points (a), (d), (f), (i), (k), (l.i) and (m) above: on the day after the notification of the confirmation is received by the coordinator.

50.3.3 Effects

- (a) for **termination of the Agreement**:

The coordinator must — within 60 days from when termination takes effect — submit:

- (i) a periodic report (for the last open reporting period until termination; see Article 20.3) and
- (ii) a final report (see Article 20.4).

If the Agreement is terminated for breach of the obligation to submit the reports (see Articles 20.8 and 50.3.1(l)), the coordinator may not submit any reports after termination.

If the JU does not receive the reports within the deadline (see above), only costs which are included in an approved periodic report will be taken into account.

The JU will **calculate** the final grant amount (see Article 5.3) and the balance (see Article 21.4) on the basis of the reports submitted. Only costs incurred until termination takes effect are eligible (see Article 6). Costs relating to contracts due for execution only after termination are not eligible.

This does not affect the JU's right to reduce the grant (see Article 43) or to impose administrative and financial penalties (Article 45).

The beneficiaries may not claim damages due to termination by the JU (see Article 46).

After termination, the beneficiaries' obligations (in particular Articles 20, 22, 23, Section 3 of Chapter 4, 36, 37, 38 and 40) continue to apply.

(b) for **termination of the participation of one or more beneficiaries:**

The coordinator must — within 60 days from when termination takes effect — submit:

- (i) a report on the distribution of payments to the beneficiary concerned;
- (ii) a request for amendment (see Article 55), with a proposal for reallocation of the tasks and estimated budget of the beneficiary concerned (see Annexes 1 and 2) and, if necessary, the addition of one or more new beneficiaries (see Article 56). If termination is notified after the period set out in Article 3, no request for amendment must be submitted unless the beneficiary concerned is the coordinator. In this case the request for amendment must propose a new coordinator, and
- (iii) if termination takes effect during the period set out in Article 3, a **termination report** from the beneficiary concerned, for the open reporting period until termination, containing an overview of the progress of the work, an overview of the use of resources, the individual financial statement and, if applicable, the certificate on the financial statement (see Article 20).

The information in the termination report must also be included in the periodic report for the next reporting period (see Article 20.3).

If the request for amendment is rejected by the JU (because it calls into question the decision awarding the grant or breaches the principle of equal treatment of applicants), the Agreement may be terminated according to Article 50.3.1(c).

If the request for amendment is accepted by the JU, the Agreement is **amended** to introduce the necessary changes (see Article 55).

The JU will **calculate** — on the basis of the periodic reports, the termination report and the report on the distribution of payments — if the (pre-financing and interim) payments received by the beneficiary concerned exceed the beneficiary's JU contribution (calculated by applying the reimbursement rate(s) to the eligible costs declared by the beneficiary *and its linked third parties* and approved by the JU). Only costs incurred by the beneficiary concerned until termination takes effect are eligible (see Article 6). Costs relating to contracts due for execution only after termination are not eligible.

- If the payments received **exceed the amounts due**:
 - if termination takes effect during the period set out in Article 3 and the request for amendment is accepted, the beneficiary concerned must repay to the coordinator the amount unduly received. The JU will formally notify the amount unduly received and request the beneficiary concerned to repay it to the coordinator within 30 days of receiving notification. If it does not repay the coordinator, the JU will draw upon the Guarantee Fund to pay the coordinator and then notify a debit note on behalf of the Guarantee Fund to the beneficiary concerned (see Article 44);
 - in all other cases, in particular if termination takes effect after the period set out in Article 3, the JU will formally notify a **debit note** to the beneficiary concerned. If payment is not made by the date in the debit note, the Guarantee Fund will pay to the JU the amount due and the JU will notify a debit note on behalf of the Guarantee Fund to the beneficiary concerned (see Article 44);
 - if the beneficiary concerned is the former coordinator, it must repay the new coordinator the amount unduly received, unless:
 - termination takes effect after an interim payment and
 - the former coordinator has not distributed amounts received as pre-financing or interim payments (see Article 21.7)

In this case, the JU will formally notify a **debit note** to the former coordinator. If payment is not made by the date in the debit note, the Guarantee Fund will pay to the JU the amount due. The JU will then pay the new coordinator and notify a debit note on behalf of the Guarantee Fund to the former coordinator (see Article 44).

- If the payments received **do not exceed the amounts due**: amounts owed to the beneficiary concerned will be included in the next interim or final payment.

If the JU does not receive the termination report within the deadline (see above), only costs included in an approved periodic report will be taken into account.

If the JU does not receive the report on the distribution of payments within the deadline (see above), it will consider that:

- the coordinator did not distribute any payment to the beneficiary concerned, and that

- the beneficiary concerned must not repay any amount to the coordinator.

After termination, the concerned beneficiary's obligations (in particular Articles 20, 22, 23, Section 3 of Chapter 4, 36, 37, 38 and 40) continue to apply.

SECTION 4 FORCE MAJEURE

ARTICLE 51 — FORCE MAJEURE

'Force majeure' means any situation or event that:

- prevents either party from fulfilling their obligations under the Agreement,
- was unforeseeable, exceptional situation and beyond the parties' control,
- was not due to error or negligence on their part (or on the part of third parties involved in the action), and
- proves to be inevitable in spite of exercising all due diligence.

The following cannot be invoked as force majeure:

- any default of a service, defect in equipment or material or delays in making them available, unless they stem directly from a relevant case of force majeure,
- labour disputes or strikes, or
- financial difficulties.

Any situation constituting force majeure must be formally notified to the other party without delay, stating the nature, likely duration and foreseeable effects.

The parties must immediately take all the necessary steps to limit any damage due to force majeure and do their best to resume implementation of the action as soon as possible.

The party prevented by force majeure from fulfilling its obligations under the Agreement cannot be considered in breach of them.

CHAPTER 7 FINAL PROVISIONS

ARTICLE 52 — COMMUNICATION BETWEEN THE PARTIES

52.1 Form and means of communication

Communication under the Agreement (information, requests, submissions, 'formal notifications', etc.) must:

- be made in writing and
- bear the number of the Agreement.

Until the payment of the balance: all communication must be made through the electronic exchange system and using the forms and templates provided there.

After the payment of the balance: formal notifications must be made by registered post with proof of delivery ('formal notification on paper').

Communications in the electronic exchange system must be made by persons authorised according to the 'Terms and Conditions of Use of the electronic exchange system'. For naming the authorised persons, each beneficiary must have designated — before the signature of this Agreement — a 'Legal Entity Appointed Representative (LEAR)'. The role and tasks of the LEAR are stipulated in his/her appointment letter (see Terms and Conditions of Use of the electronic exchange system).

If the electronic exchange system is temporarily unavailable, instructions will be given on the JU website.

52.2 Date of communication

Communications are considered to have been made when they are sent by the sending party (i.e. on the date and time they are sent through the electronic exchange system).

Formal notifications through the **electronic** exchange system are considered to have been made when they are received by the receiving party (i.e. on the date and time of acceptance by the receiving party, as indicated by the time stamp). A formal notification that has not been accepted within 10 days after sending is considered to have been accepted.

Formal notifications **on paper** sent by **registered post** with proof of delivery (only after the payment of the balance) are considered to have been made on either:

- the delivery date registered by the postal service or
- the deadline for collection at the post office.

If the electronic exchange system is temporarily unavailable, the sending party cannot be considered in breach of its obligation to send a communication within a specified deadline.

52.3 Addresses for communication

The **electronic** exchange system must be accessed via the following URL:

<https://ec.europa.eu/research/participants/portal/desktop/en/projects/>

The JU will formally notify the coordinator and beneficiaries in advance any changes to this URL.

Formal notifications on paper (only after the payment of the balance) addressed **to the JU** must be sent to the following address:

*ECSEL Joint Undertaking
B-1049 Brussels Belgium*

Formal notifications on paper (only after the payment of the balance) addressed **to the beneficiaries** must be sent to their legal address as specified in the 'Beneficiary Register'.

ARTICLE 53 — INTERPRETATION OF THE AGREEMENT

53.1 Precedence of the Terms and Conditions over the Annexes

The provisions in the Terms and Conditions of the Agreement take precedence over its Annexes.

Annex 2 takes precedence over Annex 1.

53.2 Privileges and immunities

Not applicable

ARTICLE 54 — CALCULATION OF PERIODS, DATES AND DEADLINES

In accordance with Regulation No 1182/71²⁸, periods expressed in days, months or years are calculated from the moment the triggering event occurs.

The day during which that event occurs is not considered as falling within the period.

ARTICLE 55 — AMENDMENTS TO THE AGREEMENT

55.1 Conditions

The Agreement may be amended, unless the amendment entails changes to the Agreement which would call into question the decision awarding the grant or breach the principle of equal treatment of applicants.

Amendments may be requested by any of the parties.

55.2 Procedure

The party requesting an amendment must submit a request for amendment signed in the electronic exchange system (see Article 52).

The coordinator submits and receives requests for amendment on behalf of the beneficiaries (see Annex 3).

If a change of coordinator is requested without its agreement, the submission must be done by another beneficiary (acting on behalf of the other beneficiaries).

The request for amendment must include:

- the reasons why;
- the appropriate supporting documents;
- for a change of coordinator without its agreement: the opinion of the coordinator (or proof that this opinion has been requested in writing).

²⁸ Regulation (EEC, Euratom) No 1182/71 of the Council of 3 June 1971 determining the rules applicable to periods, dates and time-limits (OJ L 124, 8.6.1971, p. 1).

The JU may request additional information.

If the party receiving the request agrees, it must sign the amendment in the electronic exchange system within 45 days of receiving notification (or any additional information the JU has requested). If it does not agree, it must formally notify its disagreement within the same deadline. The deadline may be extended, if necessary for the assessment of the request. If no notification is received within the deadline, the request is considered to have been rejected

An amendment **enters into force** on the day of the signature of the receiving party.

An amendment **takes effect** on the date agreed by the parties or, in the absence of such an agreement, on the date on which the amendment enters into force.

ARTICLE 56 — ACCESSION TO THE AGREEMENT

56.1 Accession of the beneficiaries mentioned in the Preamble

The other beneficiaries must accede to the Agreement by signing the Accession Form (see Annex 3) in the electronic exchange system (see Article 52) within 30 days after its entry into force (see Article 58).

They will assume the rights and obligations under the Agreement with effect from the date of its entry into force (see Article 58).

If a beneficiary does not accede to the Agreement within the above deadline, the coordinator must — within 30 days — request an amendment to make any changes necessary to ensure proper implementation of the action. This does not affect the JU's right to terminate the Agreement (see Article 50).

56.2 Addition of new beneficiaries

In justified cases, the beneficiaries may request the addition of a new beneficiary.

For this purpose, the coordinator must submit a request for amendment in accordance with Article 55. It must include an Accession Form (see Annex 3) signed by the new beneficiary in the electronic exchange system (see Article 52).

New beneficiaries must assume the rights and obligations under the Agreement with effect from the date of their accession specified in the Accession Form (see Annex 3).

ARTICLE 57 — APPLICABLE LAW AND SETTLEMENT OF DISPUTES

57.1 Applicable law

The Agreement is governed by the applicable EU law, supplemented if necessary by the law of Belgium.

57.2 Dispute settlement

If a dispute concerning the interpretation, application or validity of the Agreement cannot be settled amicably, the General Court — or, on appeal, the Court of Justice of the European Union — has sole

jurisdiction. Such actions must be brought under Article 272 of the Treaty on the Functioning of the EU (TFEU).

If a dispute concerns administrative or financial penalties or offsetting the beneficiaries must bring action before the General Court — or, on appeal, the Court of Justice of the European Union — under Article 263 TFEU.

ARTICLE 58 — ENTRY INTO FORCE OF THE AGREEMENT

The Agreement will enter into force on the day of signature by the JU or the coordinator, depending on which is later.

SIGNATURES

For the coordinator

For the JU



ANNEX 1 (part A)

ECSEL Research and Innovation Action

NUMBER — 737483 — WInSiC4AP

Table of Contents

1.1. The project summary.....	3
1.2. The list of beneficiaries.....	4
1.3. Workplan Tables - Detailed implementation.....	5
1.3.1. WT1 List of work packages.....	5
1.3.2. WT2 List of deliverables.....	6
1.3.3. WT3 Work package descriptions.....	22
Work package 1.....	22
Work package 2.....	25
Work package 3.....	28
Work package 4.....	33
Work package 5.....	35
Work package 6.....	39
Work package 7.....	42
Work package 8.....	44
Work package 9.....	47
Work package 10.....	55
Work package 11.....	58
Work package 12.....	61
Work package 13.....	65
1.3.4. WT4 List of milestones.....	68
1.3.5. WT5 Critical Implementation risks and mitigation actions.....	69
1.3.6 WT6 Summary of project effort in person-months.....	70
1.3.7. WT7 Tentative schedule of project reviews.....	72

1.1. The project summary

Project Number ¹	737483	Project Acronym ²	WInSiC4AP
-----------------------------	--------	------------------------------	-----------

One form per project

General information

Project title ³	Wide band gap Innovative SiC for Advanced Power
Starting date ⁴	01/06/2017
Duration in months ⁵	36
Call (part) identifier ⁶	H2020-ECSEL-2016-1-RIA-two-stage
Topic	ECSEL-2016-1 ECSEL Key Applications and Essential technologies (RIA)
Fixed EC Keywords	Technology development, Electrical and electronic engineering: semiconductors, components, systems, Electronic components, Manufacturing and fabrication technology, Design-Manufacturing
Free keywords	Wide band gap material

Abstract ⁷

WInSiC4AP core objective is to contribute in developing reliable technology bricks for efficient and cost-effective applications addressing social challenges and market segments where Europe is a recognized global leader as well as automotive, avionics, railway and defence.

WInSiC4AP approach is to rely on the strength of vertical integration allowing optimization, technologies fitting application requirements, developing the full ecosystem and approach relevant issues as reliability in the full scope. That enhances the competitiveness of EU- Industries as well as TIER1 and TIER2 down to the value chain in a market context where other countries today, such as the USA or Japan, are advancing and new players accessing SiC enter in the market.

New topologies and architecture will be developed for targeted application simulating operational environment, at laboratory level, driving the needed and still missed technologies, components and demonstrators to fill the gap between current state of the art and the very high demanding specifications.

WInSiC4AP framework has been built so that companies working in different domains (i.e. automotive car maker and TIER1-2 and avionics, railway and defence TIER1-TIER2) and in the vertical value chain (semiconductor suppliers, companies manufacturing inductors and capacitors) as well as academic entities and laboratories will collaborate to co-design solutions, solve problems and exchange know-how, such that unforeseen results may also emerge.

WInSiC4AP will be supported with synergy between ECSEL JU and ESI funding enabling complementary activities with relevant economic and social impact envisage in a less development region of Union.

1.2. List of Beneficiaries

Project Number ¹	737483	Project Acronym ²	WInSiC4AP
-----------------------------	--------	------------------------------	-----------

List of Beneficiaries

No	Name	Short name	Country	Project entry month ⁸	Project exit month
1	DISTRETTO TECNOLOGICO SICILIA MICROE NANO SISTEMI SCARL	DISMNS	Italy	1	36
2	STMICROELECTRONICS SRL	ST-I	Italy	1	36
3	UNIVERSITA DEGLI STUDI DI CATANIA	UNICT	Italy	1	36
4	NEXTER ELECTRONICS	NEXTER	France	1	36
5	VALEO SYSTEMES DE CONTROLE MOTEUR SAS	VSCM	France	1	36
6	CONSORZIO NAZIONALE INTERUNIVERSITARIO PER LA NANOELETRONICA	IUNET	Italy	1	36
7	UNIVERSITA DEGLI STUDI DI MESSINA	UNIME	Italy	1	36
8	CESKE VYSOKE UCENI TECHNICKE V PRAZE	UNIPRA	Czech Republic	1	36
9	GOTTFRIED WILHELM LEIBNIZ UNIVERSITAET HANNOVER	LUH	Germany	1	36
10	CONSIGLIO NAZIONALE DELLE RICERCHE	CNR	Italy	1	36
11	ZODIAC AERO ELECTRIC SAS	ZODAERO	France	1	36
12	APOJEE	APOJEE	France	1	36
13	APSI3D	APSI	France	1	36
14	S.A.T.SICILIANA ARTICOLI TECNICI SRL	SAT	Italy	1	36
15	WURTH ELEKTRONIK EISOS GMBH & CO KG	WÜRTH	Germany	1	36
16	UNIVERSITE FRANCOIS RABELAIS DE TOURS	UNITOU	France	1	36
17	INSTITUT MIKROELEKTRONICKYCH APLIKACI S.R.O.	IMA	Czech Republic	1	36
18	E-DISTRIBUZIONE SPA	ED	Italy	1	36
19	SOFTECO SISMAT SRL	SOFT	Italy	1	36
20	DISTRETTO TECNOLOGICO AEROSPAZIALE DELLA CAMPANIA SCARL	DAC	Italy	1	36

1.3. Workplan Tables - Detailed implementation

1.3.1. WT1 List of work packages

WP Number ⁹	WP Title	Lead beneficiary ¹⁰	Person-months ¹¹	Start month ¹²	End month ¹³
WP1	1a - Management and Coordination FE/BE for Avionics, Railway and Automotive IPS (JU Funds)	1 - DTSMNS	63.00	1	36
WP2	1b - Management and Coordination FE/BE Low Voltage for Avionics & Engine control (ESI Funds)	1 - DTSMNS	23.00	1	36
WP3	2a - Requirements and Use Case Definition	5 - VSCM	158.00	1	20
WP4	2b - Avionics Interface and Engine Control and Use Case Definition	2 - ST-I	96.00	1	6
WP5	3a - FE/BE Advanced technology bricks development & characterization (1200÷1700V SiC)	2 - ST-I	299.00	6	30
WP6	3b - FE/BE Low Voltage high current technology bricks development & characterization (650V @400A SiC)	2 - ST-I	138.00	6	28
WP7	4 - Open platform and Design Methodologies	2 - ST-I	68.00	9	28
WP8	5a - Reliability 1200÷1700V SiC	6 - IUNET	233.00	10	33
WP9	6a - Avionics, Railway and Automotive IPS and others Demonstrators	18 - ED	792.00	3	36
WP10	6b - Avionics Interface and Engine Control Demonstrators	20 - DAC	495.00	7	36
WP11	5b - Reliability 650V @400A SiC	2 - ST-I	175.00	7	32
WP12	7a - Communication & Dissemination, Exploitation, Standardization for Avionics, Railway & Automotive IPS	10 - CNR	78.00	1	36
WP13	7b - Communication & Dissemination, Exploitation, Standardization for Avionics and engine control	1 - DTSMNS	80.00	1	36
Total			2,698.00		

1.3.2. WT2 list of deliverables

Deliverable Number ¹⁴	Deliverable Title	WP number ⁹	Lead beneficiary	Type ¹⁵	Dissemination level ¹⁶	Due Date (in months) ¹⁷
D1.1	D1a.1.1 - Critical Paths and Risk Assessment	WP1	1 - DTSMNS	Report	Confidential, only for members of the consortium (including the Commission Services)	3
D1.2	D1a.1.2 - Project management handbook	WP1	1 - DTSMNS	Report	Confidential, only for members of the consortium (including the Commission Services)	3
D1.3	D1a.1.3 - Consortium Agreement (CA) and Annex IPR management database: Pre-existing know-how	WP1	1 - DTSMNS	Report	Confidential, only for members of the consortium (including the Commission Services)	4
D1.4	D1a.2.1 - GANTT Chart revalidation	WP1	1 - DTSMNS	Report	Confidential, only for members of the consortium (including the Commission Services)	6
D1.5	D1a.2.2 - First intermediate project report on progress, use of resources and financial statement	WP1	1 - DTSMNS	Report	Confidential, only for members of the consortium (including the Commission Services)	6
D1.6	D1a.2.3 - Second intermediate project report on progress, use of resources and financial statement	WP1	1 - DTSMNS	Report	Confidential, only for members of the consortium (including the Commission Services)	18
D1.7	D1a.2.4 - Last intermediate project report on progress, use of resources and financial statement	WP1	1 - DTSMNS	Report	Confidential, only for members of the consortium (including the Commission Services)	30
D1.8	D1a.3.1 - IPR management database table: Final release	WP1	1 - DTSMNS	Report	Confidential, only for members of the consortium (including the Commission Services)	30

Deliverable Number¹⁴	Deliverable Title	WP number⁹	Lead beneficiary	Type¹⁵	Dissemination level¹⁶	Due Date (in months)¹⁷
D2.1	D1b.1.1 - Critical Paths and Risk Assessment	WP2	1 - DTSMNS	Report	Confidential, only for members of the consortium (including the Commission Services)	3
D2.2	D1b.1.2 - Project management handbook	WP2	1 - DTSMNS	Report	Confidential, only for members of the consortium (including the Commission Services)	3
D2.3	D1b.2.1 - First intermediate project report on progress, use of resources and financial statement	WP2	1 - DTSMNS	Report	Confidential, only for members of the consortium (including the Commission Services)	12
D2.4	D1b.2.2 - Second intermediate project report on progress, use of resources and financial statement	WP2	1 - DTSMNS	Report	Confidential, only for members of the consortium (including the Commission Services)	24
D2.5	D1b.2.3 - Last intermediate project report on progress, use of resources and financial statement	WP2	1 - DTSMNS	Report	Confidential, only for members of the consortium (including the Commission Services)	30
D3.1	D2a.1.1 - OBC converter specifications	WP3	5 - VSCM	Report	Confidential, only for members of the consortium (including the Commission Services)	7
D3.2	D2a.1.2 - OBC converter main component specifications	WP3	5 - VSCM	Report	Confidential, only for members of the consortium (including the Commission Services)	15
D3.3	D2a.2.1 - DCDC converter specifications	WP3	5 - VSCM	Report	Confidential, only for members of the consortium (including the Commission Services)	4

Deliverable Number¹⁴	Deliverable Title	WP number⁹	Lead beneficiary	Type¹⁵	Dissemination level¹⁶	Due Date (in months)¹⁷
D3.4	D2a.2.2 - DCDC main component converter specifications	WP3	5 - VSCM	Report	Confidential, only for members of the consortium (including the Commission Services)	8
D3.5	D2a.3.1 - IPS RA Specifications for specific components	WP3	4 - NEXTER	Report	Confidential, only for members of the consortium (including the Commission Services)	4
D3.6	D2a.3.2 - IPS AA Specifications for specific components	WP3	4 - NEXTER	Report	Confidential, only for members of the consortium (including the Commission Services)	4
D3.7	D2a.3.3 - "Reflex Board" specifications and validation procedure	WP3	4 - NEXTER	Report	Confidential, only for members of the consortium (including the Commission Services)	4
D3.8	D2a.4.1 - High Efficiency Bidirectional SiC based Power Converter Specifications	WP3	18 - ED	Report	Confidential, only for members of the consortium (including the Commission Services)	7
D3.9	D2a.4.2 - Technical report on design and simulation of SiC based 7kW converters for BC and V2G.	WP3	3 - UNICT	Report	Confidential, only for members of the consortium (including the Commission Services)	7
D3.10	D2a.4.3 - Technical report on realization and testing of scaled prototypes of SiC based converters for BC and V2G.	WP3	3 - UNICT	Report	Confidential, only for members of the consortium (including the Commission Services)	7
D3.11	D2a.5.1 - Specification of avionics inverter power module	WP3	11 - ZODAERO	Report	Confidential, only for members of the consortium (including the Commission Services)	9

Deliverable Number¹⁴	Deliverable Title	WP number⁹	Lead beneficiary	Type¹⁵	Dissemination level¹⁶	Due Date (in months)¹⁷
D3.12	D2a.5.2 - Specification of avionics inverter passive components	WP3	11 - ZODAERO	Report	Confidential, only for members of the consortium (including the Commission Services)	9
D3.13	D2a.5.3 - Update of specification for avionics inverter power module	WP3	11 - ZODAERO	Report	Confidential, only for members of the consortium (including the Commission Services)	18
D3.14	D2a.5.4 - Update of specification for avionics inverter passive components	WP3	11 - ZODAERO	Report	Confidential, only for members of the consortium (including the Commission Services)	18
D3.15	D2a.6.1 - Report on core development activities and demonstrator value chain	WP3	2 - ST-I	Report	Confidential, only for members of the consortium (including the Commission Services)	20
D3.16	D2a.6.2 - Report on reliability models development, validation and their exploitation to assess the reliability level in practical cases.	WP3	3 - UNICT	Report	Confidential, only for members of the consortium (including the Commission Services)	18
D3.17	D2a.6.3 - Technical report on prognostic algorithms for demonstrator projects.	WP3	7 - UNIME	Report	Confidential, only for members of the consortium (including the Commission Services)	18
D4.1	D2b.1.1 - Report on LiPo interface specifications	WP4	20 - DAC	Report	Confidential, only for members of the consortium (including the Commission Services)	6
D4.2	D2b.2.1 - Report on Engine Controller-Inverter specifications	WP4	20 - DAC	Report	Confidential, only for members of the consortium (including the Commission Services)	6
D4.3	D2b.3.1 - Report on core development	WP4	20 - DAC	Report	Confidential, only for members	6

Deliverable Number¹⁴	Deliverable Title	WP number⁹	Lead beneficiary	Type¹⁵	Dissemination level¹⁶	Due Date (in months)¹⁷
	activities and demonstrator value chain				of the consortium (including the Commission Services)	
D5.1	D3a.1.1 - Characterization report of 1200V devices with already available design and delivery to partners	WP5	2 - ST-I	Report	Confidential, only for members of the consortium (including the Commission Services)	10
D5.2	D3a.1.2 - Advanced Package Processes and Materials for 1200V SiC – feasibility study	WP5	13 - APSI	Report	Confidential, only for members of the consortium (including the Commission Services)	12
D5.3	D3a.1.3 - Key Advanced Package Processes for 1200V SiC – development report	WP5	13 - APSI	Report	Confidential, only for members of the consortium (including the Commission Services)	30
D5.4	D3a.1.4 - Characterization report of 1200V MOSFET with new design	WP5	2 - ST-I	Report	Confidential, only for members of the consortium (including the Commission Services)	20
D5.5	D3a.2.1 - Characterization report of 1700V devices with already available design and delivery to partners	WP5	2 - ST-I	Report	Confidential, only for members of the consortium (including the Commission Services)	10
D5.6	D3a.2.2 - Advanced Package Processes and Materials for 1700V SiC – feasibility study	WP5	13 - APSI	Report	Confidential, only for members of the consortium (including the Commission Services)	12
D5.7	D3a.2.3 - Key Advanced Package Processes for 1700V SiC – development report	WP5	13 - APSI	Report	Confidential, only for members of the consortium (including the Commission Services)	30
D5.8	D3a.2.4 Characterization report of 1700V devices with new design	WP5	2 - ST-I	Report	Confidential, only for members of the consortium (including the	24

Deliverable Number¹⁴	Deliverable Title	WP number⁹	Lead beneficiary	Type¹⁵	Dissemination level¹⁶	Due Date (in months)¹⁷
					Commission Services)	
D5.9	D3a.5.1 - Discrete gate drive transformers final electrical and mechanical design incl. drawings, schematics, footprint	WP5	15 - WÜRTH	Report	Confidential, only for members of the consortium (including the Commission Services)	15
D5.10	D3a.5.2 - Discrete gate drive transformers final physical prototypes	WP5	15 - WÜRTH	Report	Confidential, only for members of the consortium (including the Commission Services)	17
D5.11	D3a.5.3 - Discrete gate drive transformers characterization report incl. electrical characteristics	WP5	15 - WÜRTH	Report	Confidential, only for members of the consortium (including the Commission Services)	20
D5.12	D3a.5.4 - Microtrafo V1 characterization report	WP5	15 - WÜRTH	Report	Confidential, only for members of the consortium (including the Commission Services)	20
D5.13	D3a.5.5 - Microtrafo V2 characterization report	WP5	15 - WÜRTH	Report	Confidential, only for members of the consortium (including the Commission Services)	28
D6.1	D3b.1.1 - Characterization report of 650V devices with already available design and delivery to partners	WP6	2 - ST-I	Report	Confidential, only for members of the consortium (including the Commission Services)	16
D6.2	D3b.1.2 - Characterization report of 650V MOSFET with new design	WP6	2 - ST-I	Report	Confidential, only for members of the consortium (including the Commission Services)	28
D6.3	D3b.2.1 - Advanced Package Processes and Materials for SiC – feasibility study	WP6	2 - ST-I	Report	Confidential, only for members of the consortium (including the Commission Services)	12

Deliverable Number¹⁴	Deliverable Title	WP number⁹	Lead beneficiary	Type¹⁵	Dissemination level¹⁶	Due Date (in months)¹⁷
D6.4	D3b.2.2 - Demonstrator Module for converters / functional with existing processes	WP6	2 - ST-I	Report	Confidential, only for members of the consortium (including the Commission Services)	12
D6.5	D3b.2.3 - Demonstrator Functional of Module for Converters with selected advanced processes	WP6	2 - ST-I	Report	Confidential, only for members of the consortium (including the Commission Services)	24
D6.6	D3b.2.4 - Advanced Package Processes and Materials for SiC – final report	WP6	2 - ST-I	Report	Confidential, only for members of the consortium (including the Commission Services)	28
D7.1	D4.1.1 - Report on design and application advanced methodologies	WP7	2 - ST-I	Report	Confidential, only for members of the consortium (including the Commission Services)	24
D7.2	D4.2.1 - Report on SiC Open Platform	WP7	2 - ST-I	Report	Confidential, only for members of the consortium (including the Commission Services)	28
D8.1	D5a.1.1 - Tests and test structure description and priorities	WP8	2 - ST-I	Report	Confidential, only for members of the consortium (including the Commission Services)	12
D8.2	D5a.1.2 - Parasitic and Breakdown phenomena in power SiC devices	WP8	2 - ST-I	Report	Confidential, only for members of the consortium (including the Commission Services)	18
D8.3	D5a.1.3 - Characterization with EL and OBIC techniques	WP8	2 - ST-I	Report	Confidential, only for members of the consortium (including the Commission Services)	33
D8.4	D5a.2.1 - Thermomechanical	WP8	2 - ST-I	Report	Confidential, only for members	28

Deliverable Number¹⁴	Deliverable Title	WP number⁹	Lead beneficiary	Type¹⁵	Dissemination level¹⁶	Due Date (in months)¹⁷
	simulations of SiC power MOSFETs				of the consortium (including the Commission Services)	
D8.5	D5a.2.2 - Reliability Assessment Report	WP8	2 - ST-I	Report	Confidential, only for members of the consortium (including the Commission Services)	33
D8.6	D5a.3.1 - TCAD reliability investigations	WP8	6 - IUNET	Report	Confidential, only for members of the consortium (including the Commission Services)	24
D8.7	D5a.3.2 - Failure analysis of power devices	WP8	6 - IUNET	Report	Confidential, only for members of the consortium (including the Commission Services)	24
D9.1	D6a.1.1 - Driver Design Report	WP9	2 - ST-I	Report	Confidential, only for members of the consortium (including the Commission Services)	12
D9.2	D6a.1.2 - IPS AA Power Module prototype with the "reflex board" including drivers	WP9	2 - ST-I	Demonstrator	Confidential, only for members of the consortium (including the Commission Services)	15
D9.3	D6a.1.3 - "Control Board" including SSPC functions	WP9	4 - NEXTER	Demonstrator	Confidential, only for members of the consortium (including the Commission Services)	15
D9.4	D6a.1.4 - Final assembly of IPS AA demonstrator mock up is realized by NEXTER	WP9	4 - NEXTER	Demonstrator	Confidential, only for members of the consortium (including the Commission Services)	18
D9.5	D6a.1.5 - Functional Test Report of SSPC by Nexter	WP9	4 - NEXTER	Report	Confidential, only for members of the consortium (including the	20

Deliverable Number¹⁴	Deliverable Title	WP number⁹	Lead beneficiary	Type¹⁵	Dissemination level¹⁶	Due Date (in months)¹⁷
					Commission Services)	
D9.6	D6a.1.6 - Specification for the integrated IPS will be consolidated between NEXTER and ST Italy for feasibility analysis	WP9	4 - NEXTER	Report	Confidential, only for members of the consortium (including the Commission Services)	24
D9.7	D6a.1.7 - ST-I will provide the integrated IPS Module according to feasibility analysis	WP9	2 - ST-I	Demonstrator	Confidential, only for members of the consortium (including the Commission Services)	15
D9.8	D6a.1.8 - Characterized Demonstrator	WP9	4 - NEXTER	Demonstrator	Confidential, only for members of the consortium (including the Commission Services)	36
D9.9	D6a.2.1 - Functional test report of Zodaero first inverter with Zodaero test	WP9	11 - ZODAERO	Report	Confidential, only for members of the consortium (including the Commission Services)	24
D9.10	D6a.2.2 - Functional test report (TRL3) of Zodaero second inverter	WP9	11 - ZODAERO	Report	Confidential, only for members of the consortium (including the Commission Services)	36
D9.11	D6a.3.1 - DC/DC Converter Architecture	WP9	5 - VSCM	Report	Confidential, only for members of the consortium (including the Commission Services)	5
D9.12	D6a.3.2 - Design Folder	WP9	5 - VSCM	Report	Confidential, only for members of the consortium (including the Commission Services)	10
D9.13	D6a.3.3 - Demonstrator assembly	WP9	5 - VSCM	Demonstrator	Confidential, only for members of the consortium (including the Commission Services)	13

Deliverable Number¹⁴	Deliverable Title	WP number⁹	Lead beneficiary	Type¹⁵	Dissemination level¹⁶	Due Date (in months)¹⁷
D9.14	D6a.3.4 - Functional Test Report	WP9	5 - VSCM	Report	Confidential, only for members of the consortium (including the Commission Services)	18
D9.15	D6a.3.5 - Qualification Report	WP9	5 - VSCM	Report	Confidential, only for members of the consortium (including the Commission Services)	24
D9.16	D6a.4.1 - Battery Charger Architecture	WP9	5 - VSCM	Report	Confidential, only for members of the consortium (including the Commission Services)	12
D9.17	D6a.4.2 - Design Folder	WP9	5 - VSCM	Report	Confidential, only for members of the consortium (including the Commission Services)	21
D9.18	D6a.4.3 - Demonstrator assembly	WP9	5 - VSCM	Demonstrator	Confidential, only for members of the consortium (including the Commission Services)	24
D9.19	D6a.4.4 - Functional Test Report	WP9	5 - VSCM	Report	Confidential, only for members of the consortium (including the Commission Services)	28
D9.20	D6a.4.5 - Qualification Report	WP9	5 - VSCM	Report	Confidential, only for members of the consortium (including the Commission Services)	32
D9.21	D6a.5.1 - Bidirectional DC/DC Converter Architecture	WP9	18 - ED	Report	Confidential, only for members of the consortium (including the Commission Services)	36
D9.22	D6a.5.2 - Design Folder	WP9	18 - ED	Report	Confidential, only for members	36

Deliverable Number¹⁴	Deliverable Title	WP number⁹	Lead beneficiary	Type¹⁵	Dissemination level¹⁶	Due Date (in months)¹⁷
					of the consortium (including the Commission Services)	
D9.23	D6a.5.3 - Demonstrator assembly	WP9	18 - ED	Demonstrator	Confidential, only for members of the consortium (including the Commission Services)	36
D9.24	D6a.5.4 - Functional Test Report	WP9	18 - ED	Report	Confidential, only for members of the consortium (including the Commission Services)	36
D9.25	D6a.5.5 - Qualification Report	WP9	18 - ED	Report	Confidential, only for members of the consortium (including the Commission Services)	36
D9.26	D6a.6.1 - IPS-RA Architecture	WP9	4 - NEXTER	Report	Confidential, only for members of the consortium (including the Commission Services)	8
D9.27	D6a.6.2 - Power Module design	WP9	2 - ST-I	Report	Confidential, only for members of the consortium (including the Commission Services)	12
D9.28	D6a.6.3 - Demonstrator assembly	WP9	13 - APSI	Demonstrator	Confidential, only for members of the consortium (including the Commission Services)	24
D9.29	D6a.6.4 - Functional Test Report	WP9	12 - APOJEE	Report	Confidential, only for members of the consortium (including the Commission Services)	30
D9.30	D6a.6.5 - Qualification Report	WP9	4 - NEXTER	Report	Confidential, only for members of the consortium (including the	32

Deliverable Number¹⁴	Deliverable Title	WP number⁹	Lead beneficiary	Type¹⁵	Dissemination level¹⁶	Due Date (in months)¹⁷
					Commission Services)	
D9.31	D6a.7.1 - Test Bench Architecture	WP9	12 - APOJEE	Report	Confidential, only for members of the consortium (including the Commission Services)	8
D9.32	D6a.7.2 - 30 kW Cell Design	WP9	12 - APOJEE	Report	Confidential, only for members of the consortium (including the Commission Services)	10
D9.33	D6a.7.3 - Rack Design	WP9	12 - APOJEE	Report	Confidential, only for members of the consortium (including the Commission Services)	12
D9.34	D6a.7.4 - Rack working in interleaved mode integration & validation	WP9	12 - APOJEE	Demonstrator	Confidential, only for members of the consortium (including the Commission Services)	15
D9.35	D6a.7.5 - Test bench in interleaved mode complete reception	WP9	12 - APOJEE	Report	Confidential, only for members of the consortium (including the Commission Services)	28
D9.36	D6a.7.6 - Report of Prototypes validation on test bench	WP9	12 - APOJEE	Report	Confidential, only for members of the consortium (including the Commission Services)	36
D9.37	D6a.7.7 - Rack working in interleaved mode integration & validation	WP9	12 - APOJEE	Demonstrator	Confidential, only for members of the consortium (including the Commission Services)	15
D10.1	D6b.1.1 - LiPo Interface Design Report	WP10	20 - DAC	Report	Confidential, only for members of the consortium (including the Commission Services)	18

Deliverable Number¹⁴	Deliverable Title	WP number⁹	Lead beneficiary	Type¹⁵	Dissemination level¹⁶	Due Date (in months)¹⁷
D10.2	D6b.2.1 - LiPo Interface Test Dummy	WP10	20 - DAC	Demonstrator	Confidential, only for members of the consortium (including the Commission Services)	24
D10.3	D6b.2.2 - LiPo Interface Demonstrator	WP10	20 - DAC	Demonstrator	Confidential, only for members of the consortium (including the Commission Services)	30
D10.4	D6b.2.3 - LiPo Interface Testing Report	WP10	20 - DAC	Report	Confidential, only for members of the consortium (including the Commission Services)	36
D10.5	D6b.3.1 - Engine Controller-Inverter Design Report	WP10	20 - DAC	Report	Confidential, only for members of the consortium (including the Commission Services)	18
D10.6	D6b.4.1 - Engine Controller-Inverter Dummy	WP10	20 - DAC	Demonstrator	Confidential, only for members of the consortium (including the Commission Services)	24
D10.7	D6b.4.2 - Engine Controller-Inverter Demonstrator	WP10	20 - DAC	Demonstrator	Confidential, only for members of the consortium (including the Commission Services)	30
D10.8	D6b.4.3 - Engine Controller-Inverter Testing Report	WP10	20 - DAC	Report	Confidential, only for members of the consortium (including the Commission Services)	36
D11.1	D5b.1.1 - Report on device characterization and parasitic effect evaluation	WP11	2 - ST-I	Report	Confidential, only for members of the consortium (including the Commission Services)	32
D11.2	D5b.2.1 - Experimental setup for mechanical	WP11	7 - UNIME	Report	Confidential, only for members	20

Deliverable Number¹⁴	Deliverable Title	WP number⁹	Lead beneficiary	Type¹⁵	Dissemination level¹⁶	Due Date (in months)¹⁷
	and thermal stress measurements				of the consortium (including the Commission Services)	
D11.3	D5b.2.2 - Analisis of failed devices	WP11	7 - UNIME	Report	Confidential, only for members of the consortium (including the Commission Services)	17
D11.4	D5b.2.3 - Device FMEA report	WP11	7 - UNIME	Report	Confidential, only for members of the consortium (including the Commission Services)	20
D11.5	D5b.2.4 - Mathematical models for reliability assessment	WP11	7 - UNIME	Report	Confidential, only for members of the consortium (including the Commission Services)	30
D11.6	D5b.3.1 - Report on failure Analysis and physical modelling	WP11	2 - ST-I	Report	Confidential, only for members of the consortium (including the Commission Services)	32
D11.7	D5b.4.1 - Report on reliability Assessment on state of art and gaps	WP11	2 - ST-I	Report	Confidential, only for members of the consortium (including the Commission Services)	32
D12.1	D7a.1.1 - Project web site	WP12	2 - ST-I	Websites, patents filling, etc.	Public	3
D12.2	D7a.1.2.1 - Database of Dissemination activities	WP12	10 - CNR	Report	Public	6
D12.3	D7a.1.2.2 - Database of Dissemination activities	WP12	10 - CNR	Report	Public	12
D12.4	D7a.1.2.3 - Database of Dissemination activities	WP12	10 - CNR	Report	Public	24
D12.5	D7a.1.2.4 - Database of Dissemination activities	WP12	10 - CNR	Report	Public	30
D12.6	D7a.2.1 - First WInSiC4AP International Workshop	WP12	6 - IUNET	Websites, patents filling, etc.	Public	20

Deliverable Number¹⁴	Deliverable Title	WP number⁹	Lead beneficiary	Type¹⁵	Dissemination level¹⁶	Due Date (in months)¹⁷
D12.7	D7a.2.2 - Second WInSiC4AP International Workshop	WP12	6 - IUNET	Websites, patents filling, etc.	Public	32
D12.8	D7a.3.1 - Report of activities on participation in Avionics, Railway & Automotive Standardization committee	WP12	2 - ST-I	Report	Confidential, only for members of the consortium (including the Commission Services)	36
D12.9	D7a.4.1.1 - Exploitation Plan	WP12	4 - NEXTER	Report	Confidential, only for members of the consortium (including the Commission Services)	24
D12.10	D7a.4.1.2 - Exploitation Plan	WP12	4 - NEXTER	Report	Confidential, only for members of the consortium (including the Commission Services)	36
D13.1	D7b.1.1.1 - Report on Dissemination activities	WP13	1 - DTSMNS	Report	Confidential, only for members of the consortium (including the Commission Services)	6
D13.2	D7b.1.1.2 - Report on Dissemination activities	WP13	1 - DTSMNS	Report	Confidential, only for members of the consortium (including the Commission Services)	12
D13.3	D7b.1.1.3 - Report on Dissemination activities	WP13	1 - DTSMNS	Report	Confidential, only for members of the consortium (including the Commission Services)	24
D13.4	D7b.1.1.4 - Report on Dissemination activities	WP13	1 - DTSMNS	Report	Confidential, only for members of the consortium (including the Commission Services)	36
D13.5	D7b.2.1 - WInSiC4AP International Workshop outcomes	WP13	1 - DTSMNS	Report	Confidential, only for members of the consortium (including the	20

Deliverable Number¹⁴	Deliverable Title	WP number⁹	Lead beneficiary	Type¹⁵	Dissemination level¹⁶	Due Date (in months)¹⁷
					Commission Services)	
D13.6	D7b.2.2 - WInSiC4AP International Workshop outcomes	WP13	1 - DTSMNS	Report	Confidential, only for members of the consortium (including the Commission Services)	32
D13.7	D7b.3.1 - Report of activities of participation to in Avionics Standardization committee	WP13	1 - DTSMNS	Report	Confidential, only for members of the consortium (including the Commission Services)	36
D13.8	D7b.4.1.1 - Partners Exploitation Plan	WP13	1 - DTSMNS	Report	Confidential, only for members of the consortium (including the Commission Services)	24
D13.9	D7b.4.1.2 - Partners Exploitation Plan	WP13	1 - DTSMNS	Report	Confidential, only for members of the consortium (including the Commission Services)	36

1.3.3. WT3 Work package descriptions

Work package number ⁹	WP1	Lead beneficiary ¹⁰	1 - DTSMNS
Work package title	1a - Management and Coordination FE/BE for Avionics, Railway and Automotive IPS (JU Funds)		
Start month	1	End month	36

Objectives

The goal of WP1.a, dedicated to FE/BE Advanced technology bricks development & characterization (1200÷1700V) SiC for “Avionics, Railway and Automotive IPS”, is to ensure that the overall objectives of the WInSiC4AP project, as outlined in the proposal, will be achieved within the planned time and budget. This requires a permanent and close monitoring with all partners in order to enable the project coordinator to control the work progress and act as interface and catalyst for the project under the ECSEL JU rules. It will also works to guarantee synchronized timing for contract negotiation and signature minimizing the risk of funding coming from different sources (JU, national and ESIF) and identifying/implementing the best mitigation measures. In this WP, beside the standard management activities, a risk analysis will be also performed to start the relevant actions to mitigate risks. Moreover the program management will identify, according to the critical paths, the various iterations for GANTT validation. A permanent and close monitoring with all partners is required in order to enable the project coordinator to control the work progress and act as interface and catalyst synchronization with ECSEL JU and/or National Authority.

Objective of this work package is to ensure that all needed actions are highlighted to identify the critical path of the project and to find the necessary amendments in the actions for the identified and/or occurring risks or any other unforeseen event.

Specific structure has been defined as described in the Program Management Section 3.2.

The main objectives of WP1a are to provide:

- Project Management
- IPR Management
- ECSEL JU rules compliance
- Communication with ECSEL JU during the project’s execution

Description of work and role of partners

WP1 - 1a - Management and Coordination FE/BE for Avionics, Railway and Automotive IPS (JU Funds)

[Months: 1-36]

DTSMNS, ST-I

A risk analysis will be performed to start the relevant actions to mitigate risks. Moreover the program management will identify, according to the critical paths, the various iterations for GANTT validation.

Set-up and implementation of all the project structures; organization of the project kick-off meeting and of the periodic reviews, management and technical meetings; execution of day-by-day project administration and progress monitoring; technical project steering; identification of potential risks and definition of appropriate recovery plans; monitoring of the performance of the Consortium partners; implementation of corrective actions to cope with possible misbehaviours of some partners; definition of standards, procedures and templates regarding matters such as documentation and review procedures; preparation and delivery to the ECSEL JU of the required documents and reports; organization and preparation of the project review meetings; preparation of the Consortium Agreement which, among other matters, will set-up proper policy and guideline for intellectual property right (IPR) management, internally and externally to the Consortium, and it will set-up and manage the IPR management database.

Participation per Partner

Partner number and short name	WP1 effort
1 - DTSMNS	43.00
2 - ST-I	20.00

Partner number and short name	WP1 effort
Total	63.00

List of deliverables

Deliverable Number ¹⁴	Deliverable Title	Lead beneficiary	Type ¹⁵	Dissemination level ¹⁶	Due Date (in months) ¹⁷
D1.1	D1a.1.1 - Critical Paths and Risk Assessment	1 - DTSMNS	Report	Confidential, only for members of the consortium (including the Commission Services)	3
D1.2	D1a.1.2 - Project management handbook	1 - DTSMNS	Report	Confidential, only for members of the consortium (including the Commission Services)	3
D1.3	D1a.1.3 - Consortium Agreement (CA) and Annex IPR management database: Pre-existing know-how	1 - DTSMNS	Report	Confidential, only for members of the consortium (including the Commission Services)	4
D1.4	D1a.2.1 - GANTT Chart revalidation	1 - DTSMNS	Report	Confidential, only for members of the consortium (including the Commission Services)	6
D1.5	D1a.2.2 - First intermediate project report on progress, use of resources and financial statement	1 - DTSMNS	Report	Confidential, only for members of the consortium (including the Commission Services)	6
D1.6	D1a.2.3 - Second intermediate project report on progress, use of resources and financial statement	1 - DTSMNS	Report	Confidential, only for members of the consortium (including the Commission Services)	18
D1.7	D1a.2.4 - Last intermediate project report on progress, use of resources and financial statement	1 - DTSMNS	Report	Confidential, only for members of the consortium (including the Commission Services)	30
D1.8	D1a.3.1 - IPR management database table: Final release	1 - DTSMNS	Report	Confidential, only for members of the consortium (including the Commission Services)	30

Description of deliverables

The deliverables will be the outcome of the following tasks:

Task 1a.1: Implementation of project management Structures

Participants: DTSMNS, ST-I;

Leader: DTSMNS.

Task 1a.2: Project management

Participants: DTSMNS, ST-I;

Leader: DTSMNS.

Task 1a.3: IPR management

Participants: DTSMNS, ST-I;

Leader: DTSMNS.

Task 1a.4 Coordination

Participants: DTSMNS;

Leader: DTSMNS.

List of deliverables:

D1.1 : D1a.1.1 - Critical Paths and Risk Assessment [3]

Critical Paths and Risk Assessment

D1.2 : D1a.1.2 - Project management handbook [3]

Project management handbook

D1.3 : D1a.1.3 - Consortium Agreement (CA) and Annex IPR management database: Pre-existing know-how [4]

Consortium Agreement (CA) and Annex IPR management database: Pre-existing know-how

D1.4 : D1a.2.1 - GANTT Chart revalidation [6]

GANTT Chart revalidation

D1.5 : D1a.2.2 - First intermediate project report on progress, use of resources and financial statement [6]

First intermediate project report on progress, use of resources and financial statement

D1.6 : D1a.2.3 - Second intermediate project report on progress, use of resources and financial statement [18]

Second intermediate project report on progress, use of resources and financial statement

D1.7 : D1a.2.4 - Last intermediate project report on progress, use of resources and financial statement [30]

Last intermediate project report on progress, use of resources and financial statement

D1.8 : D1a.3.1 - IPR management database table: Final release [30]

IPR management database table: Final release.

Schedule of relevant Milestones

Milestone number ¹⁸	Milestone title	Lead beneficiary	Due Date (in months)	Means of verification
--------------------------------	-----------------	------------------	----------------------	-----------------------

Work package number ⁹	WP2	Lead beneficiary ¹⁰	1 - DTSMNS
Work package title	1b - Management and Coordination FE/BE Low Voltage for Avionics & Engine control (ESI Funds)		
Start month	1	End month	36

Objectives

The goal of WP1.b, dedicated to FE/BE Low Voltage high current technology bricks development & characterization (650V @400A SiC) for “Avionics and engine control”, is to ensure that the overall objectives of the WInSiC4AP project, as outlined in the proposal, will be achieved within the planned time and budget. This requires a permanent and close monitoring with all partners in order to enable the project coordinator to control the work progress and act as interface and catalyst for the project under the ECSEL JU rules. It will also works to guarantee synchronized timing for contract negotiation and signature minimizing the risk of funding coming from different sources (JU, national and ESIF) and identifying/implementing the best mitigation measures. In this WP, beside the standard management activities, a risk analysis will be also performed to start the relevant actions to mitigate risks. Moreover the program management will identify, according to the critical paths, the various iterations for GANTT validation. A permanent and close monitoring with all partners is required in order to enable the project coordinator to control the work progress and act as interface and catalyst synchronization with ECSEL JU and/or National Authority.

Objective of this work package is to ensure that all needed actions are highlighted to identify the critical path of the project and to find the necessary amendments in the actions for the identified and/or occurring risks or any other unforeseen event.

Specific structure has been defined as described in the Program Management Section 3.2.

The main objectives of WP1b are to provide:

- Project Management
- ECSEL JU rules compliance
- Communication with ECSEL JU during the project’s execution

Description of work and role of partners

WP2 - 1b - Management and Coordination FE/BE Low Voltage for Avionics & Engine control (ESI Funds)
 [Months: 1-36]
DTSMNS, ST-I

A risk analysis will be performed to start the relevant actions to mitigate specific risks for the activities on FE/BE Low Voltage high current technology bricks development & characterization (650V @400A SiC) for Avionics and engine control. Moreover, in this area, the program management will identify, according to the critical paths, the various iterations for GANTT validation, the set-up and implementation of all the project structures, the organization of the project kick-off meeting and of the periodic reviews, the management and technical meetings the identification of potential risks and definition of appropriate recovery plans, the ; monitoring of the performance of the Consortium partners; the implementation of corrective actions to cope with possible misbehaviours of some partners, the definition of standards, procedures and templates regarding matters such as documentation and review procedures, the specific preparation and delivery to the ECSEL JU of the required documents and reports.

Participation per Partner

Partner number and short name	WP2 effort
1 - DTSMNS	3.00
2 - ST-I	20.00
Total	23.00

List of deliverables

Deliverable Number ¹⁴	Deliverable Title	Lead beneficiary	Type ¹⁵	Dissemination level ¹⁶	Due Date (in months) ¹⁷
D2.1	D1b.1.1 - Critical Paths and Risk Assessment	1 - DTSMNS	Report	Confidential, only for members of the consortium (including the Commission Services)	3
D2.2	D1b.1.2 - Project management handbook	1 - DTSMNS	Report	Confidential, only for members of the consortium (including the Commission Services)	3
D2.3	D1b.2.1 - First intermediate project report on progress, use of resources and financial statement	1 - DTSMNS	Report	Confidential, only for members of the consortium (including the Commission Services)	12
D2.4	D1b.2.2 - Second intermediate project report on progress, use of resources and financial statement	1 - DTSMNS	Report	Confidential, only for members of the consortium (including the Commission Services)	24
D2.5	D1b.2.3 - Last intermediate project report on progress, use of resources and financial statement	1 - DTSMNS	Report	Confidential, only for members of the consortium (including the Commission Services)	30

Description of deliverables

The deliverables will be the outcome of the following tasks:

Task 1b.1: Implementation of project management Structures

Participants: DTSMNS, ST-I;

Leader: DTSMNS.

Task 1b.2: Project management

Participants: DTSMNS, ST-I;

Leader: DTSMNS.

Task 1b.3 Coordination

Participants: DTSMNS;

Leader: DTSMNS.

List of deliverables:

D2.1 : D1b.1.1 - Critical Paths and Risk Assessment [3]

Critical Paths and Risk Assessment

D2.2 : D1b.1.2 - Project management handbook [3]

Project management handbook

D2.3 : D1b.2.1 - First intermediate project report on progress, use of resources and financial statement [12]

First intermediate project report on progress, use of resources and financial statement

D2.4 : D1b.2.2 - Second intermediate project report on progress, use of resources and financial statement [24]

Second intermediate project report on progress, use of resources and financial statement

D2.5 : D1b.2.3 - Last intermediate project report on progress, use of resources and financial statement [30]

Last intermediate project report on progress, use of resources and financial statement

Schedule of relevant Milestones

Milestone number¹⁸	Milestone title	Lead beneficiary	Due Date (in months)	Means of verification
--------------------------------------	------------------------	-------------------------	-----------------------------	------------------------------

Work package number ⁹	WP3	Lead beneficiary ¹⁰	5 - VSCM
Work package title	2a - Requirements and Use Case Definition		
Start month	1	End month	20

Objectives

In Workpackage 2a the requirements for components for future SiC based power electronic systems are defined. The defined requirements are input for the following work packages. Thus, the requirements for components can be derived from the application point of view in WP2a. Synthesis of component requirements for the 6 demonstrator projects of the JU pillar is conducted in close cooperation with STMicroelectronics. With the Synthesis of all the requirements in WP2a, a correct basis for technology brick development in WP3 is derived. In Workpackage 2a it is determined how many variants of power components will be necessary to fulfill the requirements for the different demonstrator projects as far as possible.

Description of work and role of partners

WP3 - 2a - Requirements and Use Case Definition [Months: 1-20]
VSCM, ST-I, UNICT, NEXTER, IUNET, UNIME, UNIPRA, ZODAERO, APSI, WÜRTH, IMA, ED
 WInSiC4AP will be driven by application requirements analysed by TIER1 and TIER2 on Automotive, Railway, Avionics directly linked to market roadmap established by OEMs. The work plan will be based on high-level specifications addressing the main challenges.
 Define component requirements for
 - Power module
 - DC link capacitor
 - Power inductors
 - Power transformers
 - Driver circuit
 - EMC components
 A key contribution of this work package consists in defining which of the packaging options is the most suitable. As an outcome, each demonstrator requirement (as defined in each task below) should be linked to a packaging technology. We may expect that, most often, only one packaging technology will be implemented. There may be situations, though, where both packaging technologies would be implemented, for parallel evaluations and comparison purposes.
 Reliability is a factor of paramount importance for SiC based power electronic systems addressed in Tasks 2a.1, 2a.2 and 2a.4.

Participation per Partner

Partner number and short name	WP3 effort
2 - ST-I	35.00
3 - UNICT	8.00
4 - NEXTER	9.00
5 - VSCM	37.00
6 - IUNET	0.00
UNIBO	1.00
7 - UNIME	24.00
8 - UNIPRA	3.00
11 - ZODAERO	7.00
13 - APSI	8.00

Partner number and short name	WP3 effort
15 - WÜRTH	6.00
17 - IMA	8.00
18 - ED	12.00
Total	158.00

List of deliverables

Deliverable Number ¹⁴	Deliverable Title	Lead beneficiary	Type ¹⁵	Dissemination level ¹⁶	Due Date (in months) ¹⁷
D3.1	D2a.1.1 - OBC converter specifications	5 - VSCM	Report	Confidential, only for members of the consortium (including the Commission Services)	7
D3.2	D2a.1.2 - OBC converter main component specifications	5 - VSCM	Report	Confidential, only for members of the consortium (including the Commission Services)	15
D3.3	D2a.2.1 - DCDC converter specifications	5 - VSCM	Report	Confidential, only for members of the consortium (including the Commission Services)	4
D3.4	D2a.2.2 - DCDC main component converter specifications	5 - VSCM	Report	Confidential, only for members of the consortium (including the Commission Services)	8
D3.5	D2a.3.1 - IPS RA Specifications for specific components	4 - NEXTER	Report	Confidential, only for members of the consortium (including the Commission Services)	4
D3.6	D2a.3.2 - IPS AA Specifications for specific components	4 - NEXTER	Report	Confidential, only for members of the consortium (including the Commission Services)	4
D3.7	D2a.3.3 - "Reflex Board" specifications and validation procedure	4 - NEXTER	Report	Confidential, only for members of the consortium (including the Commission Services)	4
D3.8	D2a.4.1 - High Efficiency Bidirectional	18 - ED	Report	Confidential, only for members of the consortium (including	7

List of deliverables

Deliverable Number ¹⁴	Deliverable Title	Lead beneficiary	Type ¹⁵	Dissemination level ¹⁶	Due Date (in months) ¹⁷
	SiC based Power Converter Specifications			the Commission Services)	
D3.9	D2a.4.2 - Technical report on design and simulation of SiC based 7kW converters for BC and V2G.	3 - UNICT	Report	Confidential, only for members of the consortium (including the Commission Services)	7
D3.10	D2a.4.3 - Technical report on realization and testing of scaled prototypes of SiC based converters for BC and V2G.	3 - UNICT	Report	Confidential, only for members of the consortium (including the Commission Services)	7
D3.11	D2a.5.1 - Specification of avionics inverter power module	11 - ZODAERO	Report	Confidential, only for members of the consortium (including the Commission Services)	9
D3.12	D2a.5.2 - Specification of avionics inverter passive components	11 - ZODAERO	Report	Confidential, only for members of the consortium (including the Commission Services)	9
D3.13	D2a.5.3 - Update of specification for avionics inverter power module	11 - ZODAERO	Report	Confidential, only for members of the consortium (including the Commission Services)	18
D3.14	D2a.5.4 - Update of specification for avionics inverter passive components	11 - ZODAERO	Report	Confidential, only for members of the consortium (including the Commission Services)	18
D3.15	D2a.6.1 - Report on core development activities and demonstrator value chain	2 - ST-I	Report	Confidential, only for members of the consortium (including the Commission Services)	20
D3.16	D2a.6.2 - Report on reliability models development, validation and their exploitation to assess the reliability level in practical cases.	3 - UNICT	Report	Confidential, only for members of the consortium (including the Commission Services)	18
D3.17	D2a.6.3 - Technical report on prognostic	7 - UNIME	Report	Confidential, only for members of the consortium (including	18

List of deliverables

Deliverable Number¹⁴	Deliverable Title	Lead beneficiary	Type¹⁵	Dissemination level¹⁶	Due Date (in months)¹⁷
	algorithms for demonstrator projects.			the Commission Services)	

Description of deliverables

The deliverables will be the outcome of the following tasks:

Task 2a.1: On Board battery Charger for PHEV or BEV

Participants: ST-I, UNICT, VSCM, UNIME, UNIPRA, aPSI3D, WÜRTH;

Leader: VSCM.

Task 2a.2: DC-DC Converters for HEV, BEV and FC

Participants: ST-I, UNICT, VSCM, aPSI3D, WÜRTH, UNIME;

Leader: VSCM.

Task 2a.3: Intelligent Power Switch (IPS)

Participants: ST-I, UNICT, NEXTER, VSCM, aPSI3D, Würth;

Leader: NEXTER.

Task 2a.4: Requirements and use case for High efficiency Bidirectional SiC-based Power Converter for V2G/V2H applications

Participants: ST-I, UNICT, IUNET, UNIME, ED;

Leader: ED.

Task 2a.5: Inverter for Avionics Applications

Participants: ST-I, VSCM, ZODAERO, aPSI3D, Würth;

Leader: ZODAERO.

Task 2a.6: Overall Synthesis of WP2a activities for WP3: specifications standardization at components chips, passive, module

Participants: ST-I, UNICT, UNIME, VSCM, ZODAERO, UNIPRA, aPSI3D, Würth, IMA, ED;

Leader: ST-I.

List of deliverables:

D3.1 : D2a.1.1 - OBC converter specifications [7]

OBC converter specifications

D3.2 : D2a.1.2 - OBC converter main component specifications [15]

OBC converter main component specifications

D3.3 : D2a.2.1 - DCDC converter specifications [4]

DCDC converter specifications

D3.4 : D2a.2.2 - DCDC main component converter specifications [8]

DCDC main component converter specifications

D3.5 : D2a.3.1 - IPS RA Specifications for specific components [4]

IPS RA Specifications for specific components

D3.6 : D2a.3.2 - IPS AA Specifications for specific components [4]

IPS AA Specifications for specific components

D3.7 : D2a.3.3 - “Reflex Board” specifications and validation procedure [4]

“Reflex Board” specifications and validation procedure

D3.8 : D2a.4.1 - High Efficiency Bidirectional SiC based Power Converter Specifications [7]

High Efficiency Bidirectional SiC based Power Converter Specifications

D3.9 : D2a.4.2 - Technical report on design and simulation of SiC based 7kW converters for BC and V2G. [7]
 Technical report on design and simulation of SiC based 7kW converters for BC and V2G.

D3.10 : D2a.4.3 - Technical report on realization and testing of scaled prototypes of SiC based converters for BC and V2G. [7]
 Technical report on realization and testing of scaled prototypes of SiC based converters for BC and V2G.

D3.11 : D2a.5.1 - Specification of avionics inverter power module [9]
 Specification of avionics inverter power module

D3.12 : D2a.5.2 - Specification of avionics inverter passive components [9]
 Specification of avionics inverter passive components

D3.13 : D2a.5.3 - Update of specification for avionics inverter power module [18]
 Update of specification for avionics inverter power module

D3.14 : D2a.5.4 - Update of specification for avionics inverter passive components [18]
 Update of specification for avionics inverter passive components

D3.15 : D2a.6.1 - Report on core development activities and demonstrator value chain [20]
 Report on core development activities and demonstrator value chain

D3.16 : D2a.6.2 - Report on reliability models development, validation and their exploitation to assess the reliability level in practical cases. [18]
 Report on reliability models development, validation and their exploitation to assess the reliability level in practical cases.

D3.17 : D2a.6.3 - Technical report on prognostic algorithms for demonstrator projects. [18]
 Technical report on prognostic algorithms for demonstrator projects.

Schedule of relevant Milestones

Milestone number¹⁸	Milestone title	Lead beneficiary	Due Date (in months)	Means of verification
MS1	DCDC converter specification	5 - VSCM	4	Trough deliverable D2a.2.1 at M4
MS2	DCDC converter main component specification	5 - VSCM	8	Trough deliverable D2a.2.2 at M8

Work package number ⁹	WP4	Lead beneficiary ¹⁰	2 - ST-I
Work package title	2b - Avionics Interface and Engine Control and Use Case Definition		
Start month	1	End month	6

Objectives

In WP2b the requirements, specifications and interfaces for the components, modules, systems will be defined. The focus will be on strong consistency between these, in order to achieve smooth and successful integration into the use cases and demonstrators. Parameters to measure progress beyond state of the art on demonstrator efficiency, weight, loss minimization of power converters will be defined.

Description of work and role of partners

WP4 - 2b - Avionics Interface and Engine Control and Use Case Definition [Months: 1-6]
ST-I, DTSMNS, UNICT, SAT, SOFT, DAC
 WInSiC4AP will be driven by application requirements analysed by TIER1 and TIER2 on Aerospace Avionics directly linked to market roadmap established by OEMs. The work plan will be based on high-level specifications addressing the main challenges.

Participation per Partner

Partner number and short name	WP4 effort
1 - DTSMNS	0.00
UNIPA	4.00
2 - ST-I	35.00
3 - UNICT	18.00
14 - SAT	3.00
19 - SOFT	15.00
20 - DAC	3.00
Caltec/REDAM	18.00
Total	96.00

List of deliverables

Deliverable Number ¹⁴	Deliverable Title	Lead beneficiary	Type ¹⁵	Dissemination level ¹⁶	Due Date (in months) ¹⁷
D4.1	D2b.1.1 - Report on LiPo interface specifications	20 - DAC	Report	Confidential, only for members of the consortium (including the Commission Services)	6
D4.2	D2b.2.1 - Report on Engine Controller-Inverter specifications	20 - DAC	Report	Confidential, only for members of the consortium (including	6

List of deliverables

Deliverable Number¹⁴	Deliverable Title	Lead beneficiary	Type¹⁵	Dissemination level¹⁶	Due Date (in months)¹⁷
				the Commission Services)	
D4.3	D2b.3.1 - Report on core development activities and demonstrator value chain	20 - DAC	Report	Confidential, only for members of the consortium (including the Commission Services)	6

Description of deliverables

<p>The deliverables will be the outcome of the following tasks:</p> <p>Task 2b.1: LiPo Interface Participants: DTSMNS, ST-I, SAT, DAC; Leader: DAC.</p> <p>Task 2b.2: Engine Controller-Inverter Participants: DTSMNS, ST-I, UNICT, SAT, SOFT, DAC; Leader: DAC.</p> <p>Task 2b.3: Overall Synthesis of WP2b activities for WP3: specifications standardization at components chips, passive, module Participants: DTSMNS, ST-I, UNICT, SAT, DAC; Leader: ST-I.</p> <p>List of deliverables:</p> <p>D4.1 : D2b.1.1 - Report on LiPo interface specifications [6] Definition of specifications of the LiPo interface</p> <p>D4.2 : D2b.2.1 - Report on Engine Controller-Inverter specifications [6] Definition of specifications of the Engine Controller/Inverter</p> <p>D4.3 : D2b.3.1 - Report on core development activities and demonstrator value chain [6] Analysis and description of the core development activities and demonstrator value chain</p>
--

Schedule of relevant Milestones

Milestone number¹⁸	Milestone title	Lead beneficiary	Due Date (in months)	Means of verification
MS3	LiPo and Engine Controller-Inverter specifications	20 - DAC	6	Comparison with standard products available on the market

Work package number ⁹	WP5	Lead beneficiary ¹⁰	2 - ST-I
Work package title	3a - FE/BE Advanced technology bricks development & characterization (1200÷1700V SiC)		
Start month	6	End month	30

Objectives

Front-end and back-end set up, advanced technology bricks development and relevant characterization for 1200÷1700V SiC application.
 DC-Link prototype components will be developed and defined. Power Inductors, Transformers and EMC components for the 6 project demonstrators will be defined.

Description of work and role of partners

WP5 - 3a - FE/BE Advanced technology bricks development & characterization (1200÷1700V SiC) [Months: 6-30]
ST-I, UNIPRA, LUH, CNR, APSI, WÜRTH, UNITOU, IMA
 Relevant building blocks will be identified, developed and characterized targeting 1200÷1700V SiC. Packaging options, advanced power module, passive components will be developed for the demonstrators. Two major design cycles will be performed in synchronization with demonstrators' development. Technological developments and prototypes of components for the demonstrator will be the outcome for WP6a. Automotive applications need special development and characterization of SiC wafers as: front and back metallization schemes, as well as new interconnections materials and processes for die attachment, including the hard die attach (i.e. diffusion soldering, Silver sintering with and without pressure, ...), special wire bonding like in case of clad wires, and also ribbons, frontside clip that could be soldered or sintered on the structure. To find the best compromise in terms of thermo-electrical, mechanical and reliability performances, and looking at the best structure, a new co-design approach, including both the front-end and the back-end parts and their fusion, will be implemented by means and support of CAD analysis and Finite Elements Models (FEM) using multiphysics simulators, in order to produce predictive and optimized models, reducing time to fabrication and processes & designs debug.

DC-Link and Snubber Components will be developed and defined making use of

- Film technology
- Alu-Elko technology and
- Anti-ferroelectric dielectric ceramic capacitor

where appropriate.

To ensure high efficiency and avoid high switching losses, a low inductive DC-Link design is crucial. Beside a low self-inductance of the capacitors a low inductive connection to the semiconductors is mandatory to allow fast switching of the semiconductors during turn-off without having too high voltage overshoots.

Participation per Partner

Partner number and short name	WP5 effort
2 - ST-I	75.00
8 - UNIPRA	26.00
9 - LUH	66.00
10 - CNR	10.00
13 - APSI	14.00
15 - WÜRTH	26.00
16 - UNITOU	64.00
17 - IMA	18.00

Partner number and short name	WP5 effort
Total	299.00

List of deliverables

Deliverable Number ¹⁴	Deliverable Title	Lead beneficiary	Type ¹⁵	Dissemination level ¹⁶	Due Date (in months) ¹⁷
D5.1	D3a.1.1 - Characterization report of 1200V devices with already available design and delivery to partners	2 - ST-I	Report	Confidential, only for members of the consortium (including the Commission Services)	10
D5.2	D3a.1.2 - Advanced Package Processes and Materials for 1200V SiC – feasibility study	13 - APSI	Report	Confidential, only for members of the consortium (including the Commission Services)	12
D5.3	D3a.1.3 - Key Advanced Package Processes for 1200V SiC – development report	13 - APSI	Report	Confidential, only for members of the consortium (including the Commission Services)	30
D5.4	D3a.1.4 - Characterization report of 1200V MOSFET with new design	2 - ST-I	Report	Confidential, only for members of the consortium (including the Commission Services)	20
D5.5	D3a.2.1 - Characterization report of 1700V devices with already available design and delivery to partners	2 - ST-I	Report	Confidential, only for members of the consortium (including the Commission Services)	10
D5.6	D3a.2.2 - Advanced Package Processes and Materials for 1700V SiC – feasibility study	13 - APSI	Report	Confidential, only for members of the consortium (including the Commission Services)	12
D5.7	D3a.2.3 - Key Advanced Package Processes for 1700V SiC – development report	13 - APSI	Report	Confidential, only for members of the consortium (including the Commission Services)	30
D5.8	D3a.2.4 Characterization report of 1700V devices with new design	2 - ST-I	Report	Confidential, only for members of the consortium (including the Commission Services)	24
D5.9	D3a.5.1 - Discrete gate drive transformers final	15 - WÜRTH	Report	Confidential, only for members of the	15

List of deliverables

Deliverable Number ¹⁴	Deliverable Title	Lead beneficiary	Type ¹⁵	Dissemination level ¹⁶	Due Date (in months) ¹⁷
	electrical and mechanical design incl. drawings, schematics, footprint			consortium (including the Commission Services)	
D5.10	D3a.5.2 - Discrete gate drive transformers final physical prototypes	15 - WÜRTH	Report	Confidential, only for members of the consortium (including the Commission Services)	17
D5.11	D3a.5.3 - Discrete gate drive transformers characterization report incl. electrical characteristics	15 - WÜRTH	Report	Confidential, only for members of the consortium (including the Commission Services)	20
D5.12	D3a.5.4 - Microtrafo V1 characterization report	15 - WÜRTH	Report	Confidential, only for members of the consortium (including the Commission Services)	20
D5.13	D3a.5.5 - Microtrafo V2 characterization report	15 - WÜRTH	Report	Confidential, only for members of the consortium (including the Commission Services)	28

Description of deliverables

The deliverables will be the outcome of the following tasks:

Task 3a.1: FE/BE development and Building blocks for 1200V SiC device
 Participants: ST-I, UNIPRA, LUH, CNR, aPSI3D, UNITOU, IMA;
 Leader: ST-I.

Task 3a.2 : FE/BE development and Building blocks for 1700V SiC device
 Participants: ST-I, UNIPRA, LUH, aPSI3D, UNITOU;
 Leader: ST-I.

Task 3a.5: Gate drive transformers
 Participants: ST-I, UNIPRA, LUH, WÜRTH;
 Leader: WÜRTH.

List of deliverables:

D5.1 : D3a.1.1 - Characterization report of 1200V devices with already available design and delivery to partners [10]
 Characterization report of 1200V devices with already available design and delivery to partners

D5.2 : D3a.1.2 - Advanced Package Processes and Materials for 1200V SiC – feasibility study [12]
 Advanced Package Processes and Materials for 1200V SiC – feasibility study

D5.3 : D3a.1.3 - Key Advanced Package Processes for 1200V SiC – development report [30]
 Key Advanced Package Processes for 1200V SiC – development report

D5.4 : D3a.1.4 - Characterization report of 1200V MOSFET with new design [20]
 Characterization report of 1200V MOSFET with new design

D5.5 : D3a.2.1 - Characterization report of 1700V devices with already available design and delivery to partners [10]
 Characterization report of 1700V devices with already available design and delivery to partners

D5.6 : D3a.2.2 - Advanced Package Processes and Materials for 1700V SiC – feasibility study [12]
 Advanced Package Processes and Materials for 1700V SiC – feasibility study

D5.7 : D3a.2.3 - Key Advanced Package Processes for 1700V SiC – development report [30]
 Key Advanced Package Processes for 1700V SiC – development report

D5.8 : D3a.2.4 Characterization report of 1700V devices with new design [24]
 Characterization report of 1700V devices with new design

D5.9 : D3a.5.1 - Discrete gate drive transformers final electrical and mechanical design incl. drawings, schematics, footprint [15]
 Discrete gate drive transformers final electrical and mechanical design incl. drawings, schematics, footprint

D5.10 : D3a.5.2 - Discrete gate drive transformers final physical prototypes [17]
 Discrete gate drive transformers final physical prototypes

D5.11 : D3a.5.3 - Discrete gate drive transformers characterization report incl. electrical characteristics [20]
 Discrete gate drive transformers characterization report incl. electrical characteristics

D5.12 : D3a.5.4 - Microtrafo V1 characterization report [20]
 Microtrafo V1 characterization report

D5.13 : D3a.5.5 - Microtrafo V2 characterization report [28]
 Microtrafo V2 characterization report

Schedule of relevant Milestones

Milestone number¹⁸	Milestone title	Lead beneficiary	Due Date (in months)	Means of verification
--------------------------------------	------------------------	-------------------------	-----------------------------	------------------------------

Work package number ⁹	WP6	Lead beneficiary ¹⁰	2 - ST-I
Work package title	3b - FE/BE Lov Voltage hight current technology bricks development & characterization (650V @400A SiC)		
Start month	6	End month	28

Objectives

Front-end and back-end set up, advanced technology bricks development (650V @ 400A SiC) and relevant characterization.

Description of work and role of partners

WP6 - 3b - FE/BE Lov Voltage hight current technology bricks development & characterization (650V @400A SiC) [Months: 6-28]
ST-I, UNIME, CNR, SAT
 Relevant building blocks will be identified, developed and characterized.
 Packaging options, advanced power module, passive components will be developed for the demonstrators, as well as new solutions for dielectrics. Two major design cycles will be performed in synchronization with demonstrators' development. Technological developments and prototypes of components for the demonstrator will be inputs for WP6b.

Participation per Partner

Partner number and short name	WP6 effort
2 - ST-I	80.00
7 - UNIME	18.00
10 - CNR	30.00
14 - SAT	10.00
Total	138.00

List of deliverables

Deliverable Number ¹⁴	Deliverable Title	Lead beneficiary	Type ¹⁵	Dissemination level ¹⁶	Due Date (in months) ¹⁷
D6.1	D3b.1.1 - Characterization report of 650V devices with already available design and delivery to partners	2 - ST-I	Report	Confidential, only for members of the consortium (including the Commission Services)	16
D6.2	D3b.1.2 - Characterization report of 650V MOSFET with new design	2 - ST-I	Report	Confidential, only for members of the consortium (including the Commission Services)	28
D6.3	D3b.2.1 - Advanced Package Processes and Materials for SiC – feasibility study	2 - ST-I	Report	Confidential, only for members of the consortium (including	12

List of deliverables

Deliverable Number ¹⁴	Deliverable Title	Lead beneficiary	Type ¹⁵	Dissemination level ¹⁶	Due Date (in months) ¹⁷
				the Commission Services)	
D6.4	D3b.2.2 - Demonstrator Module for converters / functional with existing processes	2 - ST-I	Report	Confidential, only for members of the consortium (including the Commission Services)	12
D6.5	D3b.2.3 - Demonstrator Functional of Module for Converters with selected advanced processes	2 - ST-I	Report	Confidential, only for members of the consortium (including the Commission Services)	24
D6.6	D3b.2.4 - Advanced Package Processes and Materials for SiC – final report	2 - ST-I	Report	Confidential, only for members of the consortium (including the Commission Services)	28

Description of deliverables

The deliverables will be the outcome of the following tasks:

Task 3b.1: FE/BE development and Building blocks for 650V SiC devices

Participants: ST-I, UNIME, CNR;

Leader: ST-I.

Task 3b.2: Process integration for innovative Power Module, development and prototyping

Participants: ST-I, UNIME, ZODAERO, SAT;

Leader: ST-I.

List of deliverables:

D6.1 : D3b.1.1 - Characterization report of 650V devices with already available design and delivery to partners [16]

Characterization report of 650V devices with already available design and delivery to partners

D6.2 : D3b.1.2 - Characterization report of 650V MOSFET with new design [28]

Characterization report of 650V MOSFET with new design

D6.3 : D3b.2.1 - Advanced Package Processes and Materials for SiC – feasibility study [12]

Advanced Package Processes and Materials for SiC – feasibility study

D6.4 : D3b.2.2 - Demonstrator Module for converters / functional with existing processes [12]

Demonstrator Module for converters / functional with existing processes

D6.5 : D3b.2.3 - Demonstrator Functional of Module for Converters with selected advanced processes [24]

Demonstrator Functional of Module for Converters with selected advanced processes

D6.6 : D3b.2.4 - Advanced Package Processes and Materials for SiC – final report [28]

Advanced Package Processes and Materials for SiC – final report

Schedule of relevant Milestones

Milestone number¹⁸	Milestone title	Lead beneficiary	Due Date (in months)	Means of verification
--------------------------------------	------------------------	-------------------------	-----------------------------	------------------------------

Work package number ⁹	WP7	Lead beneficiary ¹⁰	2 - ST-I
Work package title	4 - Open platform and Design Methodologies		
Start month	9	End month	28

Objectives

Advance beyond State-of-the-Art in discrete component modelling and simulation. Design techniques and methodologies to develop in order to secure robustness and efficiency required by next-generation devices: ambition is to cover the abstraction level from technology up to the system. Provide an open platform helping to expedite the design of new applications in SiC starting from reference model hardware.

Description of work and role of partners

WP7 - 4 - Open platform and Design Methodologies [Months: 9-28]
ST-I, VSCM, UNIPRA
 The reliability and demonstrators will drive the identifications and development of an innovative WInSiC4AP approach

Participation per Partner

Partner number and short name	WP7 effort
2 - ST-I	35.00
5 - VSCM	23.00
8 - UNIPRA	10.00
Total	68.00

List of deliverables

Deliverable Number ¹⁴	Deliverable Title	Lead beneficiary	Type ¹⁵	Dissemination level ¹⁶	Due Date (in months) ¹⁷
D7.1	D4.1.1 - Report on design and application advanced methodologies	2 - ST-I	Report	Confidential, only for members of the consortium (including the Commission Services)	24
D7.2	D4.2.1 - Report on SiC Open Platform	2 - ST-I	Report	Confidential, only for members of the consortium (including the Commission Services)	28

Description of deliverables

The deliverables will be the outcome of the following tasks:
 Task 4.1 Design and application advanced methodologies
 Participants: ST-I, VSCM, UNIPRA;
 Leader: ST-I.
 Task 4.2 From Specific Requirements to Open Platform
 Participants: ST-I, VSCM, UNIPRA;

Leader: ST-I.

List of deliverables:

D7.1 : D4.1.1 - Report on design and application advanced methodologies [24]

Report on design and application advanced methodologies

D7.2 : D4.2.1 - Report on SiC Open Platform [28]

Report on SiC Open Platform

Schedule of relevant Milestones

Milestone number ¹⁸	Milestone title	Lead beneficiary	Due Date (in months)	Means of verification
--------------------------------	-----------------	------------------	----------------------	-----------------------

Work package number ⁹	WP8	Lead beneficiary ¹⁰	6 - IUNET
Work package title	5a - Reliability 1200÷1700V SiC		
Start month	10	End month	33

Objectives

Avionics and HEV reliability analysis.
 In Workpackage 5a possible failure modes of the defined technology bricks are evaluated and the fulfilment of lifetime requirements is assessed.

Description of work and role of partners

WP8 - 5a - Reliability 1200÷1700V SiC [Months: 10-33]
 IUNET, ST-I, VSCM, UNIPRA, CNR, ZODAERO, APSI
 Reliability will be assessed particularly addressing the relevant standardization committees in the Avionics and HEV fields. Different analysis will be carried on by exploiting Avionics and HEV partners' competencies and sharing and integration of different practices will be done to explore opportunities for defining a standard approach for SiC.
 Fulfilment of lifetime requirements for passive components is assessed for each demonstrator.

Participation per Partner

Partner number and short name	WP8 effort
2 - ST-I	50.00
5 - VSCM	30.00
6 - IUNET	0.00
UNIPD	55.50
UNIBO	37.50
UNICAL	28.00
8 - UNIPRA	16.00
10 - CNR	10.00
11 - ZODAERO	4.00
13 - APSI	2.00
Total	233.00

List of deliverables

Deliverable Number ¹⁴	Deliverable Title	Lead beneficiary	Type ¹⁵	Dissemination level ¹⁶	Due Date (in months) ¹⁷
D8.1	D5a.1.1 - Tests and test structure description and priorities	2 - ST-I	Report	Confidential, only for members of the consortium (including the Commission Services)	12

List of deliverables

Deliverable Number ¹⁴	Deliverable Title	Lead beneficiary	Type ¹⁵	Dissemination level ¹⁶	Due Date (in months) ¹⁷
D8.2	D5a.1.2 - Parasitic and Breakdown phenomena in power SiC devices	2 - ST-I	Report	Confidential, only for members of the consortium (including the Commission Services)	18
D8.3	D5a.1.3 - Characterization with EL and OBIC techniques	2 - ST-I	Report	Confidential, only for members of the consortium (including the Commission Services)	33
D8.4	D5a.2.1 - Thermomechanical simulations of SiC power MOSFETs	2 - ST-I	Report	Confidential, only for members of the consortium (including the Commission Services)	28
D8.5	D5a.2.2 - Reliability Assessment Report	2 - ST-I	Report	Confidential, only for members of the consortium (including the Commission Services)	33
D8.6	D5a.3.1 - TCAD reliability investigations	6 - IUNET	Report	Confidential, only for members of the consortium (including the Commission Services)	24
D8.7	D5a.3.2 - Failure analysis of power devices	6 - IUNET	Report	Confidential, only for members of the consortium (including the Commission Services)	24

Description of deliverables

The deliverables will be the outcome of the following tasks:

Task 5a.1: Device characterization and parasitic effects evaluation

Participants: ST-I, VSCM, IUNET, UNIPRA, aPSI3D;

Leader: ST-I.

Task 5a.2: Reliability investigation of devices

Participants: ST-I, VSCM, IUNET, UNIPRA, ZODAERO, aPSI3D;

Leader: ST-I.

Task 5a.3: Failure Analysis and physical modelling

Participants: ST-I, VSCM, IUNET, UNIPRA, CNR, ZODAERO, aPSI3D;

Leader: IUNET.

List of deliverables:

D8.1 : D5a.1.1 - Tests and test structure description and priorities [12]

Tests and test structure description and priorities

D8.2 : D5a.1.2 - Parasitic and Breakdown phenomena in power SiC devices [18]

Parasitic and Breakdown phenomena in power SiC devices

D8.3 : D5a.1.3 - Characterization with EL and OBIC techniques [33]

Characterization with EL and OBIC techniques

D8.4 : D5a.2.1 - Thermomechanical simulations of SiC power MOSFETs [28]

Thermomechanical simulations of SiC power MOSFETs

D8.5 : D5a.2.2 - Reliability Assessment Report [33]

Reliability Assessment Report

D8.6 : D5a.3.1 - TCAD reliability investigations [24]

TCAD reliability investigations

D8.7 : D5a.3.2 - Failure analysis of power devices [24]

Failure analysis of power devices

Schedule of relevant Milestones

Milestone number ¹⁸	Milestone title	Lead beneficiary	Due Date (in months)	Means of verification
--------------------------------	-----------------	------------------	----------------------	-----------------------

Work package number ⁹	WP9	Lead beneficiary ¹⁰	18 - ED
Work package title	6a - Avionics, Railway and Automotive IPS and others Demonstrators		
Start month	3	End month	36

Objectives

Avionics/Automotive (HEV)/Railway Demonstrators.

Description of work and role of partners

WP9 - 6a - Avionics, Railway and Automotive IPS and others Demonstrators [Months: 3-36]
ED, ST-I, UNICT, NEXTER, VSCM, IUNET, UNIPRA, ZODAERO, APOJEE, APSI, WÜRTH, IMA
 The activities for Avionics and HEV demonstrators manufacturing will require different steps: circuit design and implementation of topologies and complete architectures, design of hardware and software control integration and assembling (Power Module, Passive components), testing and validation. Also in some cases design of discrete drivers will be part of the design flow.
 Sensors for Intelligent Power Module (IPM):
 To develop an IPM, we need to integrate a current sensor and a temperature sensor. There are two possibilities: monolithically (sensor in the Silicon Carbide die) or sensor in the module.

Participation per Partner

Partner number and short name	WP9 effort
2 - ST-I	53.00
3 - UNICT	28.00
4 - NEXTER	19.00
5 - VSCM	228.00
6 - IUNET	0.00
UNIBO	6.00
8 - UNIPRA	13.00
11 - ZODAERO	163.00
12 - APOJEE	148.00
13 - APSI	12.00
15 - WÜRTH	6.00
17 - IMA	32.00
18 - ED	84.00
Total	792.00

List of deliverables

Deliverable Number ¹⁴	Deliverable Title	Lead beneficiary	Type ¹⁵	Dissemination level ¹⁶	Due Date (in months) ¹⁷
D9.1	D6a.1.1 - Driver Design Report	2 - ST-I	Report	Confidential, only for members of the	12

List of deliverables

Deliverable Number ¹⁴	Deliverable Title	Lead beneficiary	Type ¹⁵	Dissemination level ¹⁶	Due Date (in months) ¹⁷
				consortium (including the Commission Services)	
D9.2	D6a.1.2 - IPS AA Power Module prototype with the “reflex board” including drivers	2 - ST-I	Demonstrator	Confidential, only for members of the consortium (including the Commission Services)	15
D9.3	D6a.1.3 - “Control Board” including SSPC functions	4 - NEXTER	Demonstrator	Confidential, only for members of the consortium (including the Commission Services)	15
D9.4	D6a.1.4 - Final assembly of IPS AA demonstrator mock up is realized by NEXTER	4 - NEXTER	Demonstrator	Confidential, only for members of the consortium (including the Commission Services)	18
D9.5	D6a.1.5 - Functional Test Report of SSPC by Nexter	4 - NEXTER	Report	Confidential, only for members of the consortium (including the Commission Services)	20
D9.6	D6a.1.6 - Specification for the integrated IPS will be consolidated between NEXTER and ST Italy for feasibility analysis	4 - NEXTER	Report	Confidential, only for members of the consortium (including the Commission Services)	24
D9.7	D6a.1.7 - ST-I will provide the integrated IPS Module according to feasibility analysis	2 - ST-I	Demonstrator	Confidential, only for members of the consortium (including the Commission Services)	15
D9.8	D6a.1.8 - Characterized Demonstrator	4 - NEXTER	Demonstrator	Confidential, only for members of the consortium (including the Commission Services)	36
D9.9	D6a.2.1 - Functional test report of Zodaero first inverter with Zodaero test	11 - ZODAERO	Report	Confidential, only for members of the consortium (including the Commission Services)	24
D9.10	D6a.2.2 - Functional test report (TRL3) of Zodaero second inverter	11 - ZODAERO	Report	Confidential, only for members of the consortium (including	36

List of deliverables

Deliverable Number ¹⁴	Deliverable Title	Lead beneficiary	Type ¹⁵	Dissemination level ¹⁶	Due Date (in months) ¹⁷
				the Commission Services)	
D9.11	D6a.3.1 - DC/DC Converter Architecture	5 - VSCM	Report	Confidential, only for members of the consortium (including the Commission Services)	5
D9.12	D6a.3.2 - Design Folder	5 - VSCM	Report	Confidential, only for members of the consortium (including the Commission Services)	10
D9.13	D6a.3.3 - Demonstrator assembly	5 - VSCM	Demonstrator	Confidential, only for members of the consortium (including the Commission Services)	13
D9.14	D6a.3.4 - Functional Test Report	5 - VSCM	Report	Confidential, only for members of the consortium (including the Commission Services)	18
D9.15	D6a.3.5 - Qualification Report	5 - VSCM	Report	Confidential, only for members of the consortium (including the Commission Services)	24
D9.16	D6a.4.1 - Battery Charger Architecture	5 - VSCM	Report	Confidential, only for members of the consortium (including the Commission Services)	12
D9.17	D6a.4.2 - Design Folder	5 - VSCM	Report	Confidential, only for members of the consortium (including the Commission Services)	21
D9.18	D6a.4.3 - Demonstrator assembly	5 - VSCM	Demonstrator	Confidential, only for members of the consortium (including the Commission Services)	24
D9.19	D6a.4.4 - Functional Test Report	5 - VSCM	Report	Confidential, only for members of the consortium (including the Commission Services)	28

List of deliverables

Deliverable Number ¹⁴	Deliverable Title	Lead beneficiary	Type ¹⁵	Dissemination level ¹⁶	Due Date (in months) ¹⁷
D9.20	D6a.4.5 - Qualification Report	5 - VSCM	Report	Confidential, only for members of the consortium (including the Commission Services)	32
D9.21	D6a.5.1 - Bidirectional DC/DC Converter Architecture	18 - ED	Report	Confidential, only for members of the consortium (including the Commission Services)	36
D9.22	D6a.5.2 - Design Folder	18 - ED	Report	Confidential, only for members of the consortium (including the Commission Services)	36
D9.23	D6a.5.3 - Demonstrator assembly	18 - ED	Demonstrator	Confidential, only for members of the consortium (including the Commission Services)	36
D9.24	D6a.5.4 - Functional Test Report	18 - ED	Report	Confidential, only for members of the consortium (including the Commission Services)	36
D9.25	D6a.5.5 - Qualification Report	18 - ED	Report	Confidential, only for members of the consortium (including the Commission Services)	36
D9.26	D6a.6.1 - IPS-RA Architecture	4 - NEXTER	Report	Confidential, only for members of the consortium (including the Commission Services)	8
D9.27	D6a.6.2 - Power Module design	2 - ST-I	Report	Confidential, only for members of the consortium (including the Commission Services)	12
D9.28	D6a.6.3 - Demonstrator assembly	13 - APSI	Demonstrator	Confidential, only for members of the consortium (including the Commission Services)	24
D9.29	D6a.6.4 - Functional Test Report	12 - APOJEE	Report	Confidential, only for members of the	30

List of deliverables

Deliverable Number ¹⁴	Deliverable Title	Lead beneficiary	Type ¹⁵	Dissemination level ¹⁶	Due Date (in months) ¹⁷
				consortium (including the Commission Services)	
D9.30	D6a.6.5 - Qualification Report	4 - NEXTER	Report	Confidential, only for members of the consortium (including the Commission Services)	32
D9.31	D6a.7.1 - Test Bench Architecture	12 - APOJEE	Report	Confidential, only for members of the consortium (including the Commission Services)	8
D9.32	D6a.7.2 - 30 kW Cell Design	12 - APOJEE	Report	Confidential, only for members of the consortium (including the Commission Services)	10
D9.33	D6a.7.3 - Rack Design	12 - APOJEE	Report	Confidential, only for members of the consortium (including the Commission Services)	12
D9.34	D6a.7.4 - Rack working in interleaved mode integration & validation	12 - APOJEE	Demonstrator	Confidential, only for members of the consortium (including the Commission Services)	15
D9.35	D6a.7.5 - Test bench in interleaved mode complete reception	12 - APOJEE	Report	Confidential, only for members of the consortium (including the Commission Services)	28
D9.36	D6a.7.6 - Report of Prototypes validation on test bench	12 - APOJEE	Report	Confidential, only for members of the consortium (including the Commission Services)	36
D9.37	D6a.7.7 - Rack working in interleaved mode integration & validation	12 - APOJEE	Demonstrator	Confidential, only for members of the consortium (including the Commission Services)	15

Description of deliverables

The deliverables will be the outcome of the following tasks:

Task 6a.1 Intelligent Power Switch for Avionics

Participants: ST-I, UNICT, NEXTER, ZODAERO, APOJEE, aPSI3D, Würth, ED;
Leader: NEXTER.

Task 6a.2 Inverter for Avionics

Participants: ST-I, NEXTER, ZODAERO, APOJEE, aPSI3D, Würth, ED;
Leader: ZODAERO.

Task 6a.3 Isolated DC-DC High Voltage to 12V for HEV, EV, FC

Participants: UNICT, NEXTER, VSCM, ZODAERO, APOJEE, aPSI3D, Würth, ED;
Leader: VSCM .

Task 6a.4 On board battery charger demonstrator

Participants: UNICT, NEXTER, VSCM, UNIPRA, ZODAERO, APOJEE, aPSI3D, Würth, IMA, ED;
Leader: VSCM.

Task 6a.5 High efficiency Bidirectional SiC-based Power Converter for V2G/V2H applications

Participants: ST-I, NEXTER, IUNET, APOJEE, Würth, ED;
Leader: ED.

Task 6a.6 Intelligent Power Switch for Railway

Participants: ST-I, UNICT, NEXTER, ZODAERO, APOJEE, aPSI3D, Würth;
Leader: NEXTER.

Task 6a.7 Test Bench Definition and testing

Participants: NEXTER, ZODAERO, APOJEE, IMA;
Leader: NEXTER.

List of deliverables:

D9.1 : D6a.1.1 - Driver Design Report [12]

Driver Design Report (with NEXTER supervision)

D9.2 : D6a.1.2 - IPS AA Power Module prototype with the “reflex board” including drivers [15]

IPS AA Power Module prototype with the “reflex board” including drivers (with NEXTER supervision)

D9.3 : D6a.1.3 - “Control Board” including SSPC functions [15]

“Control Board” including SSPC functions

D9.4 : D6a.1.4 - Final assembly of IPS AA demonstrator mock up is realized by NEXTER [18]

Final assembly of IPS AA demonstrator mock up is realized by NEXTER

D9.5 : D6a.1.5 - Functional Test Report of SSPC by Nexter [20]

Functional Test Report of SSPC by Nexter

D9.6 : D6a.1.6 - Specification for the integrated IPS will be consolidated between NEXTER and ST Italy for feasibility analysis [24]

Specification for the integrated IPS will be consolidated between NEXTER and ST Italy for feasibility analysis

D9.7 : D6a.1.7 - ST-I will provide the integrated IPS Module according to feasibility analysis [15]

ST-I will provide the integrated IPS Module according to feasibility analysis

D9.8 : D6a.1.8 - Characterized Demonstrator [36]

Characterized Demonstrator

D9.9 : D6a.2.1 - Functional test report of Zodaero first inverter with Zodaero test [24]

Functional test report of Zodaero first inverter with Zodaero test

D9.10 : D6a.2.2 - Functional test report (TRL3) of Zodaero second inverter [36]

Functional test report (TRL3) of Zodaero second inverter

D9.11 : D6a.3.1 - DC/DC Converter Architecture [5]

DC/DC Converter Architecture

D9.12 : D6a.3.2 - Design Folder [10]

Design Folder

D9.13 : D6a.3.3 - Demonstrator assembly [13]
Demonstrator assembly

D9.14 : D6a.3.4 - Functional Test Report [18]
Functional Test Report

D9.15 : D6a.3.5 - Qualification Report [24]
Qualification Report

D9.16 : D6a.4.1 - Battery Charger Architecture [12]
Battery Charger Architecture

D9.17 : D6a.4.2 - Design Folder [21]
Design Folder

D9.18 : D6a.4.3 - Demonstrator assembly [24]
Demonstrator assembly

D9.19 : D6a.4.4 - Functional Test Report [28]
Functional Test Report

D9.20 : D6a.4.5 - Qualification Report [32]
Qualification Report

D9.21 : D6a.5.1 - Bidirectional DC/DC Converter Architecture [36]
Bidirectional DC/DC Converter Architecture

D9.22 : D6a.5.2 - Design Folder [36]
Design Folder

D9.23 : D6a.5.3 - Demonstrator assembly [36]
Demonstrator assembly

D9.24 : D6a.5.4 - Functional Test Report [36]
Functional Test Report

D9.25 : D6a.5.5 - Qualification Report [36]
Qualification Report

D9.26 : D6a.6.1 - IPS-RA Architecture [8]
IPS-RA Architecture

D9.27 : D6a.6.2 - Power Module design [12]
Power Module design

D9.28 : D6a.6.3 - Demonstrator assembly [24]
Demonstrator assembly

D9.29 : D6a.6.4 - Functional Test Report [30]
Functional Test Report

D9.30 : D6a.6.5 - Qualification Report [32]
Qualification Report

D9.31 : D6a.7.1 - Test Bench Architecture [8]
Test Bench Architecture

D9.32 : D6a.7.2 - 30 kW Cell Design [10]
30 kW Cell Design

D9.33 : D6a.7.3 - Rack Design [12]
Rack Design

D9.34 : D6a.7.4 - Rack working in interleaved mode integration & validation [15]

Rack working in interleaved mode integration & validation
 D9.35 : D6a.7.5 - Test bench in interleaved mode complete reception [28]
 Test bench in interleaved mode complete reception
 D9.36 : D6a.7.6 - Report of Prototypes validation on test bench [36]
 Report of Prototypes validation on test bench
 D9.37 : D6a.7.7 - Rack working in interleaved mode integration & validation [15]
 Rack working in interleaved mode integration & validation

Schedule of relevant Milestones

Milestone number ¹⁸	Milestone title	Lead beneficiary	Due Date (in months)	Means of verification
MS4	IPS Demonstrator Design	2 - ST-I	12	D6a.6.2 Power Module design (NEXTER ST-I)
MS5	Availability of reliability test plan for DCDC converter	5 - VSCM	17	D5b.2.1 Experimental setup for mechanical and thermal stress measurements
MS6	Working DCDC demonstrator	5 - VSCM	19	D6a.3.4 Functional Test Report
MS7	Reliability test plan for DCDC converter	5 - VSCM	17	D6a.3.5 Qualification Report
MS8	Working OBC demonstrator	5 - VSCM	29	D6a.4.4 Functional Test Report
MS9	Reliability test plan for OBC converter	5 - VSCM	27	D6a.4.5 Qualification Report
MS10	Demonstrator assembly and manufacturing	5 - VSCM	24	D6a.4.3 Intermediate report
MS11	System characterization and validation	12 - APOJEE	28	Performance testing executed, specifications meet target
MS12	Intelligent Power Switch for Railway Functional Report	4 - NEXTER	36	Identification of points of improvements to move faster to higher TRL

Work package number ⁹	WP10	Lead beneficiary ¹⁰	20 - DAC
Work package title	6b - Avionics Interface and Engine Control Demonstrators		
Start month	7	End month	36

Objectives

Technology Airplane Avionics Industrial Demonstrators.

Description of work and role of partners

WP10 - 6b - Avionics Interface and Engine Control Demonstrators [Months: 7-36]
DAC, DTSMNS, ST-I, UNICT, SOFT
 The unmanned aerial vehicle (UAV) referenced for the development of the demonstrator is defined "All Electric", i.e. all control lines and propulsion are electromechanical; the most interesting feature is the line of propulsion power to engine and the command line to high power servos. The components involved in the following program are:

- A. LiPo interface;
- B. Engine controller-inverter.

The need is to handle currents of up to about 400 A and voltages of the order of 100 V having such objectives, to be considered extremely challenging due to aerospace typical requirements, first of all weight and reliability:

1. Benchmarks Programming for Control Loop (Embedded Software DO178B Level A)
2. Telemetry / Signal Interface
3. Light weight (Item (a) <500 g; Item (b) <1000 g)
4. EMC / minimal impact
5. ATEX impact to be assessed
6. MTBF to be evaluated (MTTR irrelevant, it manages replacement)
7. Operational Accelerations 6 g; Impact / Hard Landing to be evaluated
8. Radiant Bodies / heat dissipation to be evaluated (Baseline AL99.9%)

Participation per Partner

Partner number and short name	WP10 effort
1 - DTSMNS	10.00
UNIPA	61.00
2 - ST-I	61.00
3 - UNICT	60.00
19 - SOFT	77.00
20 - DAC	6.00
Caltec/OMI	40.00
Caltec/REDAM	180.00
Total	495.00

List of deliverables

Deliverable Number ¹⁴	Deliverable Title	Lead beneficiary	Type ¹⁵	Dissemination level ¹⁶	Due Date (in months) ¹⁷
D10.1	D6b.1.1 - LiPo Interface Design Report	20 - DAC	Report	Confidential, only for members of the consortium (including the Commission Services)	18
D10.2	D6b.2.1 - LiPo Interface Test Dummy	20 - DAC	Demonstrator	Confidential, only for members of the consortium (including the Commission Services)	24
D10.3	D6b.2.2 - LiPo Interface Demonstrator	20 - DAC	Demonstrator	Confidential, only for members of the consortium (including the Commission Services)	30
D10.4	D6b.2.3 - LiPo Interface Testing Report	20 - DAC	Report	Confidential, only for members of the consortium (including the Commission Services)	36
D10.5	D6b.3.1 - Engine Controller-Inverter Design Report	20 - DAC	Report	Confidential, only for members of the consortium (including the Commission Services)	18
D10.6	D6b.4.1 - Engine Controller-Inverter Dummy	20 - DAC	Demonstrator	Confidential, only for members of the consortium (including the Commission Services)	24
D10.7	D6b.4.2 - Engine Controller-Inverter Demonstrator	20 - DAC	Demonstrator	Confidential, only for members of the consortium (including the Commission Services)	30
D10.8	D6b.4.3 - Engine Controller-Inverter Testing Report	20 - DAC	Report	Confidential, only for members of the consortium (including the Commission Services)	36

Description of deliverables

The deliverables will be the outcome of the following tasks:

Task 6b.1: LiPo Interface Design
 Participants: DTSMNS, ST-I, UNICT, DAC;
 Leader: DAC.

Task 6b.2: LiPo Interface Realization and Testing

Participants: DTSMNS, ST-I, UNICT, SOFT, DAC;
 Leader: DAC.

Task 6b.3 Engine Controller-Inverter Design
 Participants: DTSMNS, ST-I, UNICT, DAC, SOFT;
 Leader: DAC.

Task 6b.4 Engine Controller-Inverter Realization and Testing
 Participants: DTSMNS, ST-I, UNICT, SOFT, DAC;
 Leader: DAC.

List of deliverables:

D10.1 : D6b.1.1 - LiPo Interface Design Report [18]
 Design report of the LiPo Interface

D10.2 : D6b.2.1 - LiPo Interface Test Dummy [24]
 LiPo Interface Test Dummy

D10.3 : D6b.2.2 - LiPo Interface Demonstrator [30]
 LiPo Interface Demonstrator

D10.4 : D6b.2.3 - LiPo Interface Testing Report [36]
 LiPo Interface Testing Report

D10.5 : D6b.3.1 - Engine Controller-Inverter Design Report [18]
 Engine Controller-Inverter Design Report

D10.6 : D6b.4.1 - Engine Controller-Inverter Dummy [24]
 Engine Controller-Inverter Dummy

D10.7 : D6b.4.2 - Engine Controller-Inverter Demonstrator [30]
 Engine Controller-Inverter Demonstrator

D10.8 : D6b.4.3 - Engine Controller-Inverter Testing Report [36]
 Engine Controller-Inverter Testing Report

Schedule of relevant Milestones

Milestone number ¹⁸	Milestone title	Lead beneficiary	Due Date (in months)	Means of verification
MS13	LiPo and Engine Controller-Inverter Design	20 - DAC	18	By document review
MS14	LiPo and Engine Controller-Inverter Dummy	1 - DTSMNS	25	Visual inspection
MS15	LiPo and Engine Controller-Inverter Demonstrators	20 - DAC	30	Visual inspection
MS16	LiPo and Engine Controller-Inverter Demonstrators functional testing	20 - DAC	36	Performance testing executed, specifications meet target

Work package number ⁹	WP11	Lead beneficiary ¹⁰	2 - ST-I
Work package title	5b - Reliability 650V @400A SiC		
Start month	7	End month	32

Objectives

Industrial reliability analysis

Description of work and role of partners

WP11 - 5b - Reliability 650V @400A SiC [Months: 7-32]
ST-I, UNIME, CNR, SAT
 Reliability will be assessed particularly addressing the relevant standardization committees in the industrial field. Different analysis will be carried on by exploiting industrial partners' competencies and sharing and integration of different practices will be done to explore opportunities for defining a standard approach for SiC.

Participation per Partner

Partner number and short name	WP11 effort
2 - ST-I	60.00
7 - UNIME	53.00
10 - CNR	55.00
14 - SAT	7.00
Total	175.00

List of deliverables

Deliverable Number ¹⁴	Deliverable Title	Lead beneficiary	Type ¹⁵	Dissemination level ¹⁶	Due Date (in months) ¹⁷
D11.1	D5b.1.1 - Report on device characterization and parasitic effect evaluation	2 - ST-I	Report	Confidential, only for members of the consortium (including the Commission Services)	32
D11.2	D5b.2.1 - Experimental setup for mechanical and thermal stress measurements	7 - UNIME	Report	Confidential, only for members of the consortium (including the Commission Services)	20
D11.3	D5b.2.2 - Analysis of failed devices	7 - UNIME	Report	Confidential, only for members of the consortium (including the Commission Services)	17
D11.4	D5b.2.3 - Device FMEA report	7 - UNIME	Report	Confidential, only for members of the consortium (including	20

List of deliverables

Deliverable Number ¹⁴	Deliverable Title	Lead beneficiary	Type ¹⁵	Dissemination level ¹⁶	Due Date (in months) ¹⁷
				the Commission Services)	
D11.5	D5b.2.4 - Mathematical models for reliability assessment	7 - UNIME	Report	Confidential, only for members of the consortium (including the Commission Services)	30
D11.6	D5b.3.1 - Report on failure Analysis and physical modelling	2 - ST-I	Report	Confidential, only for members of the consortium (including the Commission Services)	32
D11.7	D5b.4.1 - Report on reliability Assessment on state of art and gaps	2 - ST-I	Report	Confidential, only for members of the consortium (including the Commission Services)	32

Description of deliverables

The deliverables will be the outcome of the following tasks:

Task 5b.1: Device characterization and parasitic effects evaluation

Participants: ST-I, CNR, SAT;

Leader: ST-I.

Task 5b.2: Reliability investigation of devices

Participants: ST-I, UNIME, CNR, SAT;

Leader: UNIME.

Task 5b.3: Failure Analysis and physical modelling

Participants: ST-I, UNIME, CNR, SAT;

Leader: ST-I.

Task 5b.4: Reliability Assessment on state of art and gaps vs. WInSiC4AP application scope

Participants: ST-I, UNIME, SAT;

Leader: ST-I

List of deliverables:

D11.1 : D5b.1.1 - Report on device characterization and parasitic effect evaluation [32]

Report on device characterization and parasitic effect evaluation

D11.2 : D5b.2.1 - Experimental setup for mechanical and thermal stress measurements [20]

Experimental setup for mechanical and thermal stress measurements

D11.3 : D5b.2.2 - Analysis of failed devices [17]

Analysis of failed devices

D11.4 : D5b.2.3 - Device FMEA report [20]

Device FMEA report

D11.5 : D5b.2.4 - Mathematical models for reliability assessment [30]

Mathematical models for reliability assessment

D11.6 : D5b.3.1 - Report on failure Analysis and physical modelling [32]

Report on failure Analysis and physical modelling

D11.7 : D5b.4.1 - Report on reliability Assessment on state of art and gaps [32]

Report on reliability Assessment on state of art and gaps

Schedule of relevant Milestones

Milestone number¹⁸	Milestone title	Lead beneficiary	Due Date (in months)	Means of verification
--------------------------------------	------------------------	-------------------------	-----------------------------	------------------------------

Work package number ⁹	WP12	Lead beneficiary ¹⁰	10 - CNR
Work package title	7a - Communication & Dissemination, Exploitation, Standardization for Avionics, Railway & Automotive IPS		
Start month	1	End month	36

Objectives

The main goal of this work package is to elaborate and coordinate a plan of communication & dissemination, as well as exploitation and standardization the proposed activities (i.e., in the field of Avionic, Railway and HEV, etc.). The objective is structured on three levels:

- 1) Definition and execution of the dissemination activities arranged into a logical sequence during the project life time. The activities are aimed to support the widest adoption of project results in education, research, industry and creation of market opportunities for the participants.
- 2) Definition and execution of the exploitation activities essential to maximize the strategic socio-economic impact and technology transfer to the market. This will be addressed by the Partners specifically involved in the Avionics & HEV activities.
- 3) Definition and execution of the specific activities related to standardization issue, voltages, recommendations for development, process and maintenance in life of new power components.

The activities detailed above will greatly benefit from a well-balanced, competent and comprehensive consortium, including engineers and scientists from industry and SME's, as well as researchers, instructors and students from educational institutions and research centres. Due to the worldwide influence of the material manufacturers, equipment developers and system-integrator partners, the consortium will be able to provide a direct exploitation path and will be able to guarantee dissemination of the developed IPs at the highest level.

Description of work and role of partners

WP12 - 7a - Communication & Dissemination, Exploitation, Standardization for Avionics, Railway & Automotive IPS [Months: 1-36]
CNR, ST-I, UNICT, NEXTER, VSCM, IUNET, UNIME, UNIPRA, LUH, ZODAERO, APOJEE, APSI, WÜRTH, UNITOU, IMA, ED
 Strong communication activities will be carried out to disseminate the progresses and the results obtained during the project duration. Dissemination phase will take place in networks and conference events. Other specific communication means (e.g., press releases) will be used to intercept the Avionic, Railway and HEV community.

Participation per Partner

Partner number and short name	WP12 effort
2 - ST-I	20.00
3 - UNICT	4.00
4 - NEXTER	1.00
5 - VSCM	8.00
6 - IUNET	0.00
UNIPD	2.50
UNIBO	3.50
UNICAL	2.00
7 - UNIME	1.00
8 - UNIPRA	4.00
9 - LUH	3.00

Partner number and short name	WP12 effort
10 - CNR	4.00
11 - ZODAERO	6.00
12 - APOJEE	1.00
13 - APSI	2.00
15 - WÜRTH	4.00
16 - UNITOU	4.00
17 - IMA	2.00
18 - ED	6.00
Total	78.00

List of deliverables

Deliverable Number ¹⁴	Deliverable Title	Lead beneficiary	Type ¹⁵	Dissemination level ¹⁶	Due Date (in months) ¹⁷
D12.1	D7a.1.1 - Project web site	2 - ST-I	Websites, patents filling, etc.	Public	3
D12.2	D7a.1.2.1 - Database of Dissemination activities	10 - CNR	Report	Public	6
D12.3	D7a.1.2.2 - Database of Dissemination activities	10 - CNR	Report	Public	12
D12.4	D7a.1.2.3 - Database of Dissemination activities	10 - CNR	Report	Public	24
D12.5	D7a.1.2.4 - Database of Dissemination activities	10 - CNR	Report	Public	30
D12.6	D7a.2.1 - First WInSiC4AP International Workshop	6 - IUNET	Websites, patents filling, etc.	Public	20
D12.7	D7a.2.2 - Second WInSiC4AP International Workshop	6 - IUNET	Websites, patents filling, etc.	Public	32
D12.8	D7a.3.1 - Report of activities on participation in Avionics, Railway & Automotive Standardization committee	2 - ST-I	Report	Confidential, only for members of the consortium (including the Commission Services)	36
D12.9	D7a.4.1.1 - Exploitation Plan	4 - NEXTER	Report	Confidential, only for members of the consortium (including the Commission Services)	24

List of deliverables

Deliverable Number¹⁴	Deliverable Title	Lead beneficiary	Type¹⁵	Dissemination level¹⁶	Due Date (in months)¹⁷
D12.10	D7a.4.1.2 - Exploitation Plan	4 - NEXTER	Report	Confidential, only for members of the consortium (including the Commission Services)	36

Description of deliverables

The deliverables will be the outcome of the following tasks:

Task 7a.1 Dissemination and Communication Strategies in Avionics, Railway & Automotive HEV fields
 Participants: ST-I, UNICT, NEXTER, VSCM, IUNET, UNIME, UNIPRA, LUH, CNR, ZODAERO, APOJEE, aPSI3D, WÜRTH, UNITOU, IMA, ED;
 Leader: CNR.

Task 7a.2 Publications, Conferences and Workshops
 Participants: ST-I, NEXTER, VSCM, IUNET, UNIME, UNIPRA, LUH, CNR, ZODAERO, APOJEE, aPSI3D, WÜRTH, UNITOU, IMA, ED;
 Leader: IUNET.

Task 7a.3 Participation in Avionics, Railway & Automotive Standardization committee
 Participants: ST-I, NEXTER, VSCM, ZODAERO, APOJEE, aPSI3D, WÜRTH;
 Leader: ST-I.

Task 7a.4 Exploitation in Avionics, Railway & Automotive fields
 Participants: ST-I, NEXTER, VSCM, IUNET, UNIPRA, LUH, CNR, ZODAERO, APOJEE, aPSI3D, WÜRTH, UNITOU, IMA, ED;
 Leader: NEXTER.

List of deliverables:

D12.1 : D7a.1.1 - Project web site [3]
 Project web site

D12.2 : D7a.1.2.1 - Database of Dissemination activities [6]
 Database of Dissemination activities

D12.3 : D7a.1.2.2 - Database of Dissemination activities [12]
 Database of Dissemination activities

D12.4 : D7a.1.2.3 - Database of Dissemination activities [24]
 Database of Dissemination activities

D12.5 : D7a.1.2.4 - Database of Dissemination activities [30]
 Database of Dissemination activities

D12.6 : D7a.2.1 - First WInSiC4AP International Workshop [20]
 First WInSiC4AP International Workshop

D12.7 : D7a.2.2 - Second WInSiC4AP International Workshop [32]
 Second WInSiC4AP International Workshop

D12.8 : D7a.3.1 - Report of activities on participation in Avionics, Railway & Automotive Standardization committee [36]

Report of activities on participation in Avionics, Railway & Automotive Standardization committee

D12.9 : D7a.4.1.1 - Exploitation Plan [24]

Exploitation Plan

D12.10 : D7a.4.1.2 - Exploitation Plan [36]

Exploitation Plan

Schedule of relevant Milestones

Milestone number¹⁸	Milestone title	Lead beneficiary	Due Date (in months)	Means of verification
--------------------------------------	------------------------	-------------------------	-----------------------------	------------------------------

Work package number ⁹	WP13	Lead beneficiary ¹⁰	1 - DTSMNS
Work package title	7b - Communication & Dissemination, Exploitation, Standardization for Avionics and engine control		
Start month	1	End month	36

Objectives

The main goal of this work package is to elaborate and coordinate a plan of communication & dissemination, as well as exploitation and standardization for Avionics activities related to WPnb in synergism with activities related to WP7a. It is remarked that the present WP activities differ from those of WP7a as they focus on stakeholders specific to the aviation field (companies, SME, airlines Universities,...), with particular attention to the National chain.

Also in WP7b objective is structured on three levels:

- 1) Definition and execution of the dissemination activities arranged into a logical sequence during the project life time. The activities are aimed to support the widest adoption of ESIF project results in education, research, industry and creation of market opportunities for the participants.
- 2) Definition and execution of the exploitation activities essentials to maximize the strategic socio-economic impact and technology transfer to the market. This will be addressed to the Partners involved in the Avionics activities.
- 3) Definition and execution of the specific activities related to standardization issue, voltages, recommendations for development, process and maintenance in life of new power components. In particular, execution of necessary activities in order to obtain Part Number for the new power components from the Regulation Agency (ENAC), which will be also involved into the design of certified industrial process and maintenance in life of new power components.

The activities detailed above will greatly benefit from a well-balanced, competent and comprehensive Avionic WInSiC4AP partners: DAC consists of a network of 150 players in Avionics field, in addition DTSMNS - through its linked party UNIPA (DIID & DICAM Departments) will be able to provide a direct exploitation path and it will be able to guarantee dissemination of the developed IP at the highest level.

Description of work and role of partners

WP13 - 7b - Communication & Dissemination, Exploitation, Standardization for Avionics and engine control
 [Months: 1-36]
DTSMNS, ST-I, UNICT, UNIME, CNR, SAT, SOFT, DAC
 Strong communication activities will be carried out to disseminate the progresses and the results obtained during the project duration. Dissemination phase will take place in networks and conference events. Other specific communication means (e.g., press releases) will be used to intercept the Avionic community in synergism with WP7a.

Participation per Partner

Partner number and short name	WP13 effort
1 - DTSMNS	2.00
UNIPA	14.00
2 - ST-I	20.00
3 - UNICT	8.00
7 - UNIME	2.00
10 - CNR	8.00
14 - SAT	3.00
19 - SOFT	5.00
20 - DAC	18.00
Total	80.00

List of deliverables

Deliverable Number¹⁴	Deliverable Title	Lead beneficiary	Type¹⁵	Dissemination level¹⁶	Due Date (in months)¹⁷
D13.1	D7b.1.1.1 - Report on Dissemination activities	1 - DTSMNS	Report	Confidential, only for members of the consortium (including the Commission Services)	6
D13.2	D7b.1.1.2 - Report on Dissemination activities	1 - DTSMNS	Report	Confidential, only for members of the consortium (including the Commission Services)	12
D13.3	D7b.1.1.3 - Report on Dissemination activities	1 - DTSMNS	Report	Confidential, only for members of the consortium (including the Commission Services)	24
D13.4	D7b.1.1.4 - Report on Dissemination activities	1 - DTSMNS	Report	Confidential, only for members of the consortium (including the Commission Services)	36
D13.5	D7b.2.1 - WInSiC4AP International Workshop outcomes	1 - DTSMNS	Report	Confidential, only for members of the consortium (including the Commission Services)	20
D13.6	D7b.2.2 - WInSiC4AP International Workshop outcomes	1 - DTSMNS	Report	Confidential, only for members of the consortium (including the Commission Services)	32
D13.7	D7b.3.1 - Report of activities of participation to in Avionics Standardization committee	1 - DTSMNS	Report	Confidential, only for members of the consortium (including the Commission Services)	36
D13.8	D7b.4.1.1 - Partners Exploitation Plan	1 - DTSMNS	Report	Confidential, only for members of the consortium (including the Commission Services)	24
D13.9	D7b.4.1.2 - Partners Exploitation Plan	1 - DTSMNS	Report	Confidential, only for members of the consortium (including the Commission Services)	36

Description of deliverables

The deliverables will be the outcome of the following tasks:

Task 7b.1 Dissemination and Communication Strategies in Avionics fields
 Participants: DTSMNS, ST-I, UNICT, UNIME, CNR, SAT, SOFT, DAC;
 Leader: DTSMNS.

Task 7b.2 Conferences and Workshops in Avionics
 Participants: DTSMNS, ST-I, UNICT, UNIME, CNR, SAT, SOFT, DAC;
 Leader: DTSMNS.

Task 7b.3 Participation in Avionics Standardization committee
 Participants: DTSMNS, ST-I, SAT, SOFT, DAC;
 Leader: DTSMNS.

Task 7b.4 Exploitation in Avionics fields
 Participants: DTSMNS, ST-I, UNICT, UNIME, CNR, SAT, SOFT, DAC;
 Leader: DTSMNS.

List of deliverables:

D13.1 : D7b.1.1.1 - Report on Dissemination activities [6]
 Report on Dissemination activities

D13.2 : D7b.1.1.2 - Report on Dissemination activities [12]
 Report on Dissemination activities

D13.3 : D7b.1.1.3 - Report on Dissemination activities [24]
 Report on Dissemination activities

D13.4 : D7b.1.1.4 - Report on Dissemination activities [36]
 Report on Dissemination activities

D13.5 : D7b.2.1 - WInSiC4AP International Workshop outcomes [20]
 WInSiC4AP International Workshop outcomes

D13.6 : D7b.2.2 - WInSiC4AP International Workshop outcomes [32]
 WInSiC4AP International Workshop outcomes

D13.7 : D7b.3.1 - Report of activities of participation to in Avionics Standardization committee [36]
 Report of activities of participation to in Avionics Standardization committee

D13.8 : D7b.4.1.1 - Partners Exploitation Plan [24]
 Partners Exploitation Plan

D13.9 : D7b.4.1.2 - Partners Exploitation Plan [36]
 Partners Exploitation Plan

Schedule of relevant Milestones

Milestone number ¹⁸	Milestone title	Lead beneficiary	Due Date (in months)	Means of verification
--------------------------------	-----------------	------------------	----------------------	-----------------------

1.3.4. WT4 List of milestones

Milestone number ¹⁸	Milestone title	WP number ⁹	Lead beneficiary	Due Date (in months) ¹⁷	Means of verification
MS1	DCDC converter specification	WP3	5 - VSCM	4	Trough deliverable D2a.2.1 at M4
MS2	DCDC converter main component specification	WP3	5 - VSCM	8	Trough deliverable D2a.2.2 at M8
MS3	LiPo and Engine Controller-Inverter specifications	WP4	20 - DAC	6	Comparison with standard products available on the market
MS4	IPS Demonstrator Design	WP9	2 - ST-I	12	D6a.6.2 Power Module design (NEXTER ST-I)
MS5	Availability of reliability test plan for DCDC converter	WP9	5 - VSCM	17	D5b.2.1 Experimental setup for mechanical and thermal stress measurements
MS6	Working DCDC demonstrator	WP9	5 - VSCM	19	D6a.3.4 Functional Test Report
MS7	Reliability test plan for DCDC converter	WP9	5 - VSCM	17	D6a.3.5 Qualification Report
MS8	Working OBC demonstrator	WP9	5 - VSCM	29	D6a.4.4 Functional Test Report
MS9	Reliability test plan for OBC converter	WP9	5 - VSCM	27	D6a.4.5 Qualification Report
MS10	Demonstrator assembly and manufacturing	WP9	5 - VSCM	24	D6a.4.3 Intermediate report
MS11	System characterization and validation	WP9	12 - APOJEE	28	Performance testing executed, specifications meet target
MS12	Intelligent Power Switch for Railway Functional Report	WP9	4 - NEXTER	36	Identification of points of improvements to move faster to higher TRL
MS13	LiPo and Engine Controller-Inverter Design	WP10	20 - DAC	18	By document review
MS14	LiPo and Engine Controller-Inverter Dummy	WP10	1 - DTSMNS	25	Visual inspection
MS15	LiPo and Engine Controller-Inverter Demonstrators	WP10	20 - DAC	30	Visual inspection
MS16	LiPo and Engine Controller-Inverter Demonstrators functional testing	WP10	20 - DAC	36	Performance testing executed, specifications meet target

1.3.5. WT5 Critical Implementation risks and mitigation actions

Risk number	Description of risk	WP Number	Proposed risk-mitigation measures
1	Synthesis of overall specifications	WP3, WP4	It's highlighted as critical path, it will be the focus of the first months of the project
2	Link between Reliability and failure model analysis and change of design rule	WP11, WP5, WP6, WP8	Different design cycle have been identified to mitigate the risk
3	Advanced processes and materials technology implementation	WP5, WP6	Identification of the minimum target for project success
4	Module prototype delay	WP5, WP6	2 design cycle are identified and decision points have been planned
5	Passive Components delay	WP5	2 design cycle are identified
6	Demonstrators success	WP10, WP9	Dedicated project management by demonstrator will identify critical path ad risk mitigation measures
7	WInSiC4AP ESIF delayed as planned for the project starting date	WP1	The proposal has been structured defining Task/ WPna supported by JU/National funding and Task/WPnb supported by ESIF. If ESIF grant agreement with National Authorities will delay, WInSiC4AP will start anyway with setting up of the not related activities. If this will happen (6 months delay) from WInSiC4AP starting date, remedial actions will be implemented. The modular and scalable approach followed in WInSiC4AP will ensure anyway the project execution for JU Pillar activities and Italian key partners involved in WPna can start to work anyway having part of budget covered by JU/National funding. This risk is low because National Authorities have already officially addressed 15MEuro to the RIA Call.

1.3.6. WT6 Summary of project effort in person-months

	WP1	WP2	WP3	WP4	WP5	WP6	WP7	WP8	WP9	WP10	WP11	WP12	WP13	Total Person/ Months per Participant
1 - DTMNS	43	3	0	0	0	0	0	0	0	10	0	0	2	58
· UNIPA	0	0	0	4	0	0	0	0	0	61	0	0	14	79
2 - ST-I	20	20	35	35	75	80	35	50	53	61	60	20	20	564
3 - UNICT	0	0	8	18	0	0	0	0	28	60	0	4	8	126
4 - NEXTER	0	0	9	0	0	0	0	0	19	0	0	1	0	29
5 - VSCM	0	0	37	0	0	0	23	30	228	0	0	8	0	326
6 - IUNET	0	0	0	0	0	0	0	0	0	0	0	0	0	0
· UNIPD	0	0	0	0	0	0	0	55.50	0	0	0	2.50	0	58
· UNIBO	0	0	1	0	0	0	0	37.50	6	0	0	3.50	0	48
· UNICAL	0	0	0	0	0	0	0	28	0	0	0	2	0	30
7 - UNIME	0	0	24	0	0	18	0	0	0	0	53	1	2	98
8 - UNIPRA	0	0	3	0	26	0	10	16	13	0	0	4	0	72
9 - LUH	0	0	0	0	66	0	0	0	0	0	0	3	0	69
10 - CNR	0	0	0	0	10	30	0	10	0	0	55	4	8	117
11 - ZODAERO	0	0	7	0	0	0	0	4	163	0	0	6	0	180
12 - APOJEE	0	0	0	0	0	0	0	0	148	0	0	1	0	149
13 - APSI	0	0	8	0	14	0	0	2	12	0	0	2	0	38
14 - SAT	0	0	0	3	0	10	0	0	0	0	7	0	3	23
15 - WÜRTH	0	0	6	0	26	0	0	0	6	0	0	4	0	42
16 - UNITOU	0	0	0	0	64	0	0	0	0	0	0	4	0	68
17 - IMA	0	0	8	0	18	0	0	0	32	0	0	2	0	60
18 - ED	0	0	12	0	0	0	0	0	84	0	0	6	0	102
19 - SOFT	0	0	0	15	0	0	0	0	0	77	0	0	5	97

	WP1	WP2	WP3	WP4	WP5	WP6	WP7	WP8	WP9	WP10	WP11	WP12	WP13	Total Person/ Months per Participant
20 - DAC	0	0	0	3	0	0	0	0	0	6	0	0	18	27
· Caltec/OMI	0	0	0	0	0	0	0	0	0	40	0	0	0	40
· Caltec/REDAM	0	0	0	18	0	0	0	0	0	180	0	0	0	198
Total Person/Months	63	23	158	96	299	138	68	233	792	495	175	78	80	2698

1.3.7. WT7 Tentative schedule of project reviews

Review number ¹⁹	Tentative timing	Planned venue of review	Comments, if any
RV1	14	ECSEL or consotium location choice	planned venue/timing may change for duly justified reason
RV2	26	ECSEL or consotium location choice	planned venue/timing may change for duly justified reason
RV3	36	ECSEL or consotium location choice	planned venue/timing may change for duly justified reason

1. Project number

The project number has been assigned by the Commission as the unique identifier for your project. It cannot be changed. The project number **should appear on each page of the grant agreement preparation documents (part A and part B)** to prevent errors during its handling.

2. Project acronym

Use the project acronym as given in the submitted proposal. It can generally not be changed. The same acronym **should appear on each page of the grant agreement preparation documents (part A and part B)** to prevent errors during its handling.

3. Project title

Use the title (preferably no longer than 200 characters) as indicated in the submitted proposal. Minor corrections are possible if agreed during the preparation of the grant agreement.

4. Starting date

Unless a specific (fixed) starting date is duly justified and agreed upon during the preparation of the Grant Agreement, the project will start on the first day of the month following the entry into force of the Grant Agreement (NB : entry into force = signature by the JU). Please note that if a fixed starting date is used, you will be required to provide a written justification.

5. Duration

Insert the duration of the project in full months.

6. Call (part) identifier

The Call (part) identifier is the reference number given in the call or part of the call you were addressing, as indicated in the publication of the call in the Official Journal of the European Union. You have to use the identifier given by the Commission in the letter inviting to prepare the grant agreement.

7. Abstract

8. Project Entry Month

The month at which the participant joined the consortium, month 1 marking the start date of the project, and all other start dates being relative to this start date.

9. Work Package number

Work package number: WP1, WP2, WP3, ..., WPn

10. Lead beneficiary

This must be one of the beneficiaries in the grant (not a third party) - Number of the beneficiary leading the work in this work package

11. Person-months per work package

The total number of person-months allocated to each work package.

12. Start month

Relative start date for the work in the specific work packages, month 1 marking the start date of the project, and all other start dates being relative to this start date.

13. End month

Relative end date, month 1 marking the start date of the project, and all end dates being relative to this start date.

14. Deliverable number

Deliverable numbers: D1 - Dn

15. Type

Please indicate the type of the deliverable using one of the following codes:

- R Document, report
- DEM Demonstrator, pilot, prototype
- DEC Websites, patent filings, videos, etc.
- OTHER
- ETHICS Ethics requirement
- ORDP Open Research Data Pilot

16. Dissemination level

Please indicate the dissemination level using one of the following codes:

- PU Public
- CO Confidential, only for members of the consortium (including the Commission Services)
- EU-RES Classified Information: RESTREINT UE (Commission Decision 2005/444/EC)
- EU-CON Classified Information: CONFIDENTIEL UE (Commission Decision 2005/444/EC)
- EU-SEC Classified Information: SECRET UE (Commission Decision 2005/444/EC)

17. Delivery date for Deliverable

Month in which the deliverables will be available, month 1 marking the start date of the project, and all delivery dates being relative to this start date.

18. Milestone number

Milestone number: MS1, MS2, ..., MSn

19. Review number

Review number: RV1, RV2, ..., RVn

20. Installation Number

Number progressively the installations of a same infrastructure. An installation is a part of an infrastructure that could be used independently from the rest.

21. Installation country

Code of the country where the installation is located or IO if the access provider (the beneficiary or linked third party) is an international organization, an ERIC or a similar legal entity.

22. Type of access

- VA if virtual access,
- TA-uc if trans-national access with access costs declared on the basis of unit cost,
- TA-ac if trans-national access with access costs declared as actual costs, and
- TA-cb if trans-national access with access costs declared as a combination of actual costs and costs on the basis of unit cost.

23. Access costs

Cost of the access provided under the project. For virtual access fill only the second column. For trans-national access fill one of the two columns or both according to the way access costs are declared. Trans-national access costs on the basis of unit cost will result from the unit cost by the quantity of access to be provided.



WInSiC4AP
Wide band gap *Innovative SiC* for Advanced *Power*

ANNEX 1 (part B)

ECSEL Research and Innovation Action

NUMBER — 737483 — WInSiC4AP

History of changes

Version:	Data	Notes
Technical Annex <i>WInSiC4AP</i>	20/09/2016 at 16:47:23	Version uploaded in the Participial Portal and approved.
Annex 1 Part B (Technical Annex <i>WInSiC4AP</i>)	10/05/2017	This version

Notes to the Version 08/05/2017

This document is an updated version of the approved Part B: Technical Annex as posted in the Participant portal on 20/09/2016 at 16:47:23.

The changes in this release are due:

- a) to the withdrawal from the project of the partners EPCSOS-DE, EPCOS-AT, CEA, INSA;
- b) to the PAB decision to have all Italian partners (except DTSMNS, IUNET, and ED) financed only by ESI funds.

The activities of the retired partners were "not_core", their actions have been in a minor part deleted, in great part redistributed among the other partners (see for details the below Table "Reshape of activities"). The Project remains in this new configuration truly solid and sustainable, no impact is in place considering objectives, milestones and demonstrators. This version reports just a slight time reschedule of a few activities, without impacts on final demonstrators availability.

Table Reshape of activities

WInSiC4AP Reprogram due to the withdrawal of CEA, EPCOS-AT, EPCOS -DE, and INSA partners.

WP	WP leader	WP Description	Task	Task leader	Task Description	Remarks
2a	VSCM	Requirements and use cases definition	All except 2a4	VSCM, NEXTER, ZODAERO, ST-I	Requirements for the different components	EPCOS-AT, EPCOS-DE not in a core requirements definition. Other partners in the WP will take care of the requirements activities.
3a	ST-I	FE/BE Advanced technology bricks development & characterization (1200+1700V SiC)	3a.1	ST-I	FE/BE development and Building blocks for 1200V SiC device	INSA not in a core WP3 activities, its technical tests with draw will just need a proper time rescheduling. Other partners will take care of characterization activities.
			3a.2	ST-I	FE/BE development and Building blocks for 1700V SiC device	INSA not in a core WP3 activities, its technical tests with draw will just need a proper time rescheduling. Other partners will take care of characterization activities.
			3a.3	CEA	Smart Power substrate and Process Integration	The task will be deleted . CEA substrates parallel investigation will be skipped without impact on WInSiC4AP application deliverables. INSA activities will be deleted because of its marginal core contribution.
			3a.4	EPCOS-DE	Components: Capacitors, Inductive Components, EMC-Filters	The task will deleted . EPCOS-AT, EPCOS-DE and INSA development of passive components are not core activities in the WInSiC4AP project. All activities related to design, characterization of passive components will be deleted. WInSiC4AP will benefit of passive components available on the market.
4	ST-I	Open platform and Design Methodologies	4a.1	ST-I	Design and application advanced methodologies	EPCOS-AT, EPCOS-DE and INSA activities will be deleted because of its marginal core contribution. ST will lead the task.
			4a.2	ST-I	From Specific Requirements to Open Platform	EPCOS-AT, EPCOS-DE and INSA withdraw without impact on the task.
5a	IUNET	Reliability 1200+1700V SiC	5a.1	ST-I	Device characterization and parasitic effects evaluation	INSA was not in core activities in this WP, its technical tests withdrawal will just need slight rescheduling among partners.
			5a.2	ST-I	Investigation of devices	INSA not in a core WP activities, its technical tests with draw will just need slight rescheduling among partners.
			5a.4	EPCOS-AT	Reliability on passive component for WInSiC4AP application scope	Task will be deleted . EPCOS-AT and EPCOS-DE passives will be replaced by market availability
6a	NEXTER	Avionics, Railway and Automotive IPS Demonstrators and others	All	NEXTER, ZODAERO, VSCM, ED, APOJEE.	Demonstrators	EPCOS-AT and EPCOS-DE is not more required because WInSiC4AP will use passive components already available on the market.

Table of Contents

TECHNICAL ACRONYMS USED IN THE DOCUMENT 4

1. EXCELLENCE 5

 1.1 Objectives 5

 1.2 Relation to the work plan 10

 1.3 Concept and approach 12

 1.4 Ambition 20

 1.4.1 Ambitions in key applications 20

 1.4.2 Ambitions in essential capabilities 35

 1.4.3 Ambition in Smart System Integration 41

2. IMPACT 49

 2.1 Expected impacts 49

 2.2 Measures to maximise impact 56

3. IMPLEMENTATION 66

 3.1 Work plan — Work packages, deliverables and milestones 66

 3.1.1 Brief presentation of the overall structure of the work plan 66

 3.1.2 Macro Planning Schedule 70

 Table 3.1a: Work package description (removed) 72

 Table 3.1b: List of work packages (removed) 115

 Table 3.1c: List of Deliverables (removed) 115

 3.2 Management structure and procedures 118

 Table 3.2a: List of milestones (removed) 122

 Table 3.2b: Critical risks for implementation (removed) 122

 3.3 Consortium as a whole 123

 3.4 Resources to be committed 127

 Table 3.4a: Summary of staff effort (removed) 127

 Table 3.4b: Other direct cost items (travel, equipment, other goods and services, large research infrastructure) 129

 Table 3.4c: Support through ESI Funds 132

SECTION 4: MEMBERS OF THE CONSORTIUM 134

 4.1. Participants (applicants) 134

 Table 1: Legal Entity Tables 134

 Table 2: Relevant Publications (Journals, Conferences, IP deposition) 173

 4.2. Third parties involved in the project (including use of third party resources) 182

SECTION 5: ETHICS AND SECURITY 192

 5.1 Ethics 192

 5.2 Security 192

6 PUBLISHABLE SUMMARY 193

Technical Acronyms used in the document

AFM	Atomic Force Microscopy
AMB	Active Metal Brazing
ATC	Air Traffic Control
BEV	Battery Electric Vehicle
CAD	Computer Aided Design
DSO	Distribution System Operator
EMC	Electromagnetic Compatibility
ESIF	European Structural Investment Funding
EV	Electric Vehicle
FC	Fuel Cell
FCEV	Fuel Cell Electric Vehicle
FEM	Finite Elements Models
GaN	Gallium Nitride
HEV	Hybrid Electric Vehicle
HTB	High Temperature Bias
HTFB	High Temperature Forward Bias
HTS	High Temperature Storage
IoT	Internet Of Things
KGD	Known Good Dice
LiPo	lithium-ion polymer
MEA	More Electrical Aircraft
MRO	Maintenance, Repair and Operation
NIT	Near Interface Trap
OAT	Outside Ambient Temperature
OBC	On Board battery Charger
OBIC	Optical Beam Induced Current
OEM	Original Equipment Manufacturer
OLT	Operative Life Test
PHEV	Plug-in Hybrid vehicles
R&D	Research and Development
S&T	Science and Technology
SiC	Silicon Carbide
SSRM	Scanning Spreading Resistance Microscopy
TCAD	Technology Computer Aided Design
THB	Temperature Humidity Bias
TSO	Transmission system Operator
UAV	unmanned aerial vehicle
XRD	X-Ray Diffraction

1.Excellence

1.1 Objectives

As it is well known, Silicon Carbide (SiC) represents, together with Gallium Nitride (GaN), the forthcoming alternative to Silicon (Si), for to get higher efficiency and higher power density. This is due to SiC devices capabilities to withstand

- very high temperatures
- high breakdown voltages
- high frequency
- high electric field.

For these reasons, power systems based on SiC semiconductors can present a much higher efficiency (lower $R_{DS(on)}$) and power density, also with smaller dimensions and lower losses for passive components (higher switching frequency) and miniaturized auxiliary cooling systems (higher operation temperature). On the contrary SiC poses strong challenges from the electromagnetic compatibility (EMC) point of view.

For many years only Schottky diodes have been available on the market because of technological problems in the elimination of doping defects. Also the difficulty in realizing sufficiently good oxide interfaces with SiC have initially tampered the development of transistors, which are the basis for the development of power converters. In 2008, the first commercial junction field effect transistors (JFET) rated at 1200V were introduced to the market, followed in 2011 by the first commercial metal oxide semiconductor field effect transistors (MOSFET) rated at 1200V. However, performance and reliability issues are still limiting the growth of SiC technology.

Moreover, additional challenges for fully unleashing the capabilities of SiC power devices are to be addressed, namely:

- Gate drivers: SiC devices often require gate voltages much different from their silicon counterparts, and also sometimes asymmetric (e.g. +20V and -5V).
- Packaging: SiC chips may have a higher power density than silicon power devices and are able to handle higher temperatures exceeding the actual silicon limit of 150 °C. New die attach technologies are required to efficiently get the heat out of the devices and ensure a reliable interconnection.
- Again, the packaging requires thorough studies for what concerns the parasitic effects (mainly inductances) to work at high frequency.
- Auxiliary devices: the control stages in a power conversion systems will still be made on Si devices which shall coexist with SiC running at higher temperature and higher frequency: proper shielding for both electromagnetic compatibility (EMC) and heat dissipation must be applied.

Figure 1 show the well-known merit curve by comparing Si to SiC and GaN. High temperature and frequency switching are reported against the behaviour of energy gap, electric field, thermal conductivity, melting point and electron velocity.

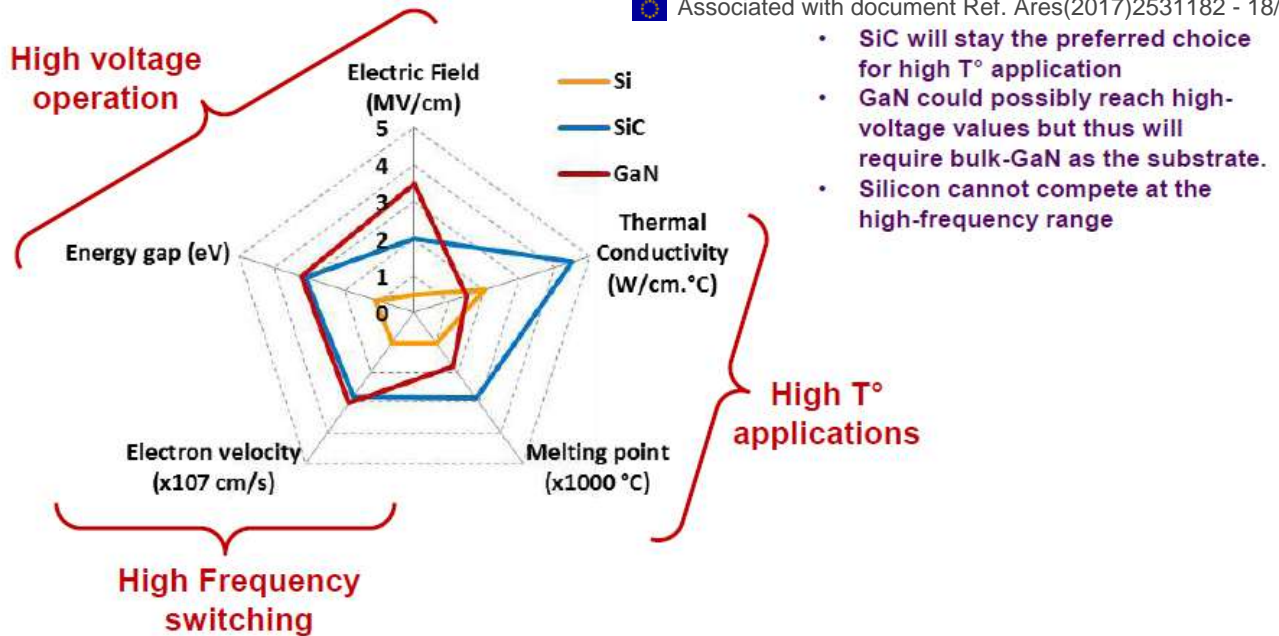

Figure 1: Merit curve of Si, SiC and GaN [Source: Yole Développement]

Aviation industry encompasses operation, maintenance, and production of aircrafts, primarily heavier-than-air aircrafts. Aerospace sector, on the other hand, includes engineering and business of flying in the space (astronautics) and atmosphere of Earth (aeronautics). Aviation and aerospace sector can be segmented into air transport & logistics, civil aircraft, airlines, airports, civil avionics, ATC & sensors, civil aviation MRO, civil aviation & airport security, civil helicopters, civil aviation engines & fuel, civil unmanned aerial vehicles, general aviation & aerospace, civil aviation training and simulation, space, and aerospace parts & materials.

Global aerospace and aviation market is anticipated to grow at a moderate pace, primarily fuelled by high replacement rate, increased aircraft size, change in technologies and growing demand from emerging economies, primarily in some Asian countries because of their burgeoning middle class.

Aviation industry is facing number of challenges such as safety and security concerns, growing consumer expectations, pressure to reduce cost and improve operational efficiency. To overcome these challenges, aviation industry need to put in place adequate security measures and increase investment in advanced security equipment; provide personalized services to customers and initiate modernisation drive to improve aircraft interior and provide in-flight entertainment options. Aerospace and aviation industry is striving to reduce carbon dioxide emissions in response to tight environment regulations in North America and Europe. Consequently, the industry has announced to cap emissions from 2020 and cut emissions by half till 2050 compared to 2005. More specifically, reduction of NO_x emissions of 80% by 2020 and 90% by 2050, reduction of fuel consumption and CO₂ emissions of 50% by 2020 and 75% by 2050.

New avionics architecture and solutions are needed for:

- Energy optimization (Low Power WIPS, Electrical Landing gears, EPGDS, E-ECS, ..)
- Fuel & noise reduction
- Lower Maintenance costs through upgraded capabilities
- Health Monitoring (architectures, integration in avionics, data collection, advanced model)
- Advanced Fly-by-Wire (Advanced and affordable flight control system architecture, Load control and Load Alleviation System).

Availability of technology that can guarantee reduced mass keeping the same functionalities, or increased functionalities with the same mass, or both reduced mass and increased functionalities is one of the important aspects to let aerospace to grow. In particular, all this is true and applicable in the avionics sector and availability of SiC-based components or equipment will help.

Although SiC devices are already available at 1200V applications, with production primarily in PV-Windmills inverters, the technology is not yet fully deployed in all applications forecasted for the Project and where it could be a key enabling technology with breakthrough impacts. Figure 2 shows application field vs. operative voltages.

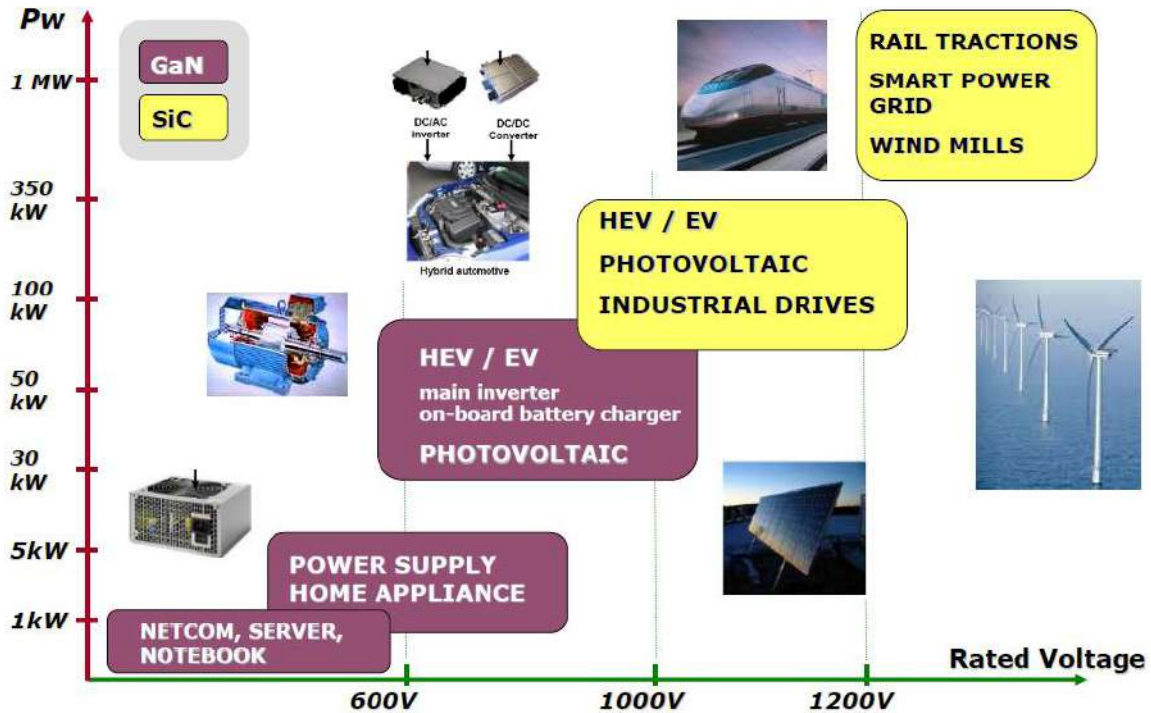

Figure 2: Voltage range vs. application

Now that nearly the full spectrum of devices is available in SiC, still the components are not yet tailored for the different applications or does not comply with the standard requirements of each sector. As from these premises it is evident that future use of SiC, in particular in the key sectors of mobility (electric road vehicles, railway systems, airplanes aerospace avionics) and energy distribution and conversion, require a co-design of the system, of the semiconductors (together with its packaging) and of the passive components.

The major aim of the WInSiC4AP Project is therefore to design, prototype and demonstrate SiC based highly integrated power demonstrators, ready for a successful industrialization, by bringing together the semiconductor and packaging producers (STMicroelectronics, aPSI^{3D}), advanced processes (SAT), the passive component producers (WÜRTH), the power converter utilizers (VALEO, NEXTER, ZODAERO, APOJEE), systems electronics (IMA), software development (SOFTECO) and the final users (ED, DAC), all supported by RTO and Universities Labs under the whole coordination of DTSMNS. In synthesis the outcome of the WInSiC4AP project will be the design and the demonstration of enhanced SiC components for automotive, railway and avionic qualification driven by the following applications:

1. On Board battery Charger for PHEV or BEV (VSCM)
2. Isolated DC-DC Converter for HEV, BEV and FC (VSCM)
3. Intelligent Power Switch (IPS-RA) (NEXTER)
(IPS-RA): High Voltage Power Converters (<10 kV) for embedded railway equipment's
4. Intelligent Power Switch (IPS-AA) (NEXTER)
(IPS-AA): AC & DC Intelligent Power Switch (IPS) for power distribution in avionics at module and component levels.
5. High efficiency Bidirectional SiC-based Power Converter for V2G/V2H applications in a nano/microgrid scenario (ED)
6. Inverter for Avionics Applications (ZODAERO)

- 7. LiPo Interface for Aerospace (DAC)
- 8. Engine Controller-Inverter for Aerospace (DAC)

The strategy of the project is to design the power switching starting from the applications by standardizing the requirements coming from different application field into application specific dies and power modules which can be made ready for qualification in the different regulatory scenarios. Particular care will be given to the design tools and methodologies with the ambition to cover the abstraction level from technology up to the power system through a reliable modelling ready to be used in system simulators. This will also address EMC issues correlated with high switching frequencies. The models, the components and the demo-systems will be validated together against the desired requirements.

As showed in Figure 3 working at application will enable to drill down to the whole components and to tailor them to the application requirements.

Therefore, **objectives at application level will be supported by the following Essential capabilities:**

- An extensive reliability and failure modelling analysis to drive chip design;
- advanced packaging options: materials, bonding processes
- innovative materials and components like passive components and interconnection technologies
- Design methodologies for co-development of reliable and high efficiency applications

In particular, two approaches will be followed on Power Module integration:

- **Incremental innovations** will be implemented in the Prototype Demonstrators according to their development maturity during the project and when mandatory for the performance of the Demonstrators. It will become part of the WInSiC4AP development platform.
- **Radical innovations** will not be used in Prototype Demonstrators but will be conceived for compatibility with a future development, industrialization and use if results are positive, in the platform. They will be studied using prototypes or at technology brick level.

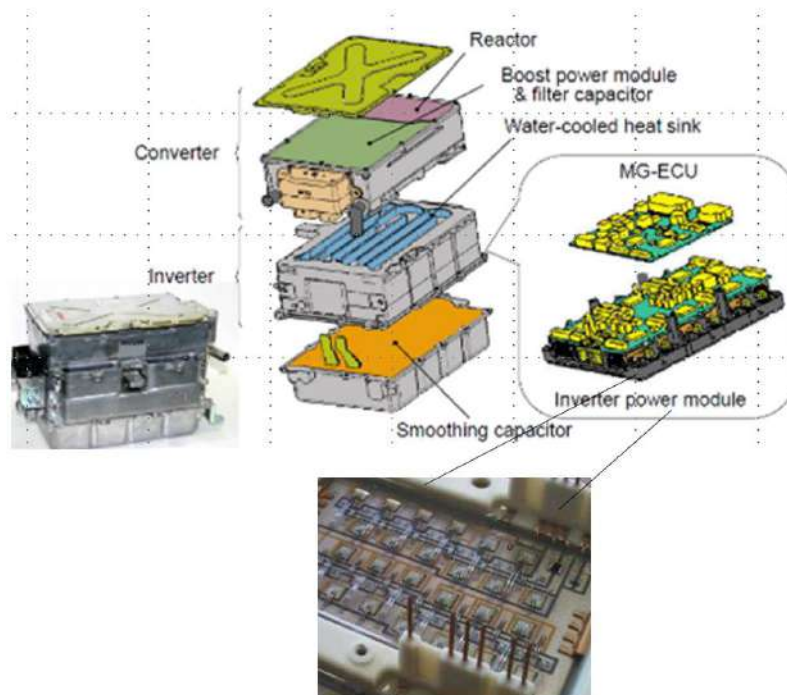

Figure 3. An inverter consists of four different parts: the power electronics drive board, the power module, the capacitor and the cooling system

Societal and Economic impact is relevant as few percent of efficiency improvements in power conversion can lead to impressive energy saving effects.

Reliability, efficiency improvements, cost and size reductions, designed-and-manufactured-in-EU are the most relevant challenges addressed in the WInSiC4AP project that are expected to lead to a strong European supply chain for SiC converters for the addressed applications; **the ambition of WInSiC4AP is to play a primary role towards excellence in Europe: first generations of prototype and components, primary access to IPs for the relevant essential capabilities, competitiveness of manufacturing in Europe.**

In the next paragraphs, detailed explanations of the whole project work plan are reported.

1.2 Relation to the work plan

In the WInSiC4AP approach, the MASP topics are related to **Key Applications** and **Essential capabilities**.

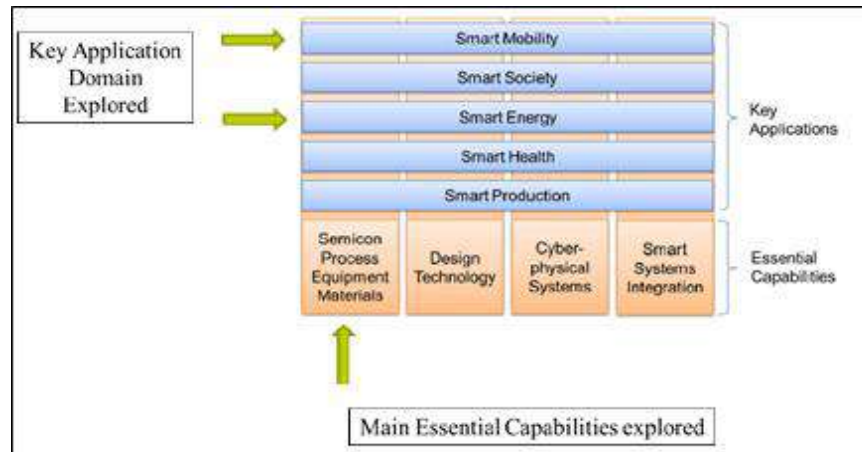

Figure 4. MASP topics, arrows indicate the key applications and essential capabilities addressed by WInSiC4AP

Addressed MASP chapters challenges vs WP key applications

MASP chapters	WP key applications
6 Smart mobility	1.1 ECS for resource efficient vehicles ECS for resource
8 Smart energy	3.2 Reduction of energy consumption

The Key Application objectives explored in the frame of the WInSiC4AP project will have a direct impact on both MASP objectives in terms of the cost – efficiency curve.

These topics are explored and linked to other initiatives supported by ECSEL, like the European Green Vehicles Initiative PPP, JTIs such as Clean Sky 2 (see 2016 MASRIA).

Cost-effective high performance directly impacts the market with new affordable solutions for electrical vehicles.

In figure below the chart represents how the SiC technology structure generates added value in the requirements of an overall power system:

- Low losses → fewer cooling needs
- High switching frequency → Small filters and passives

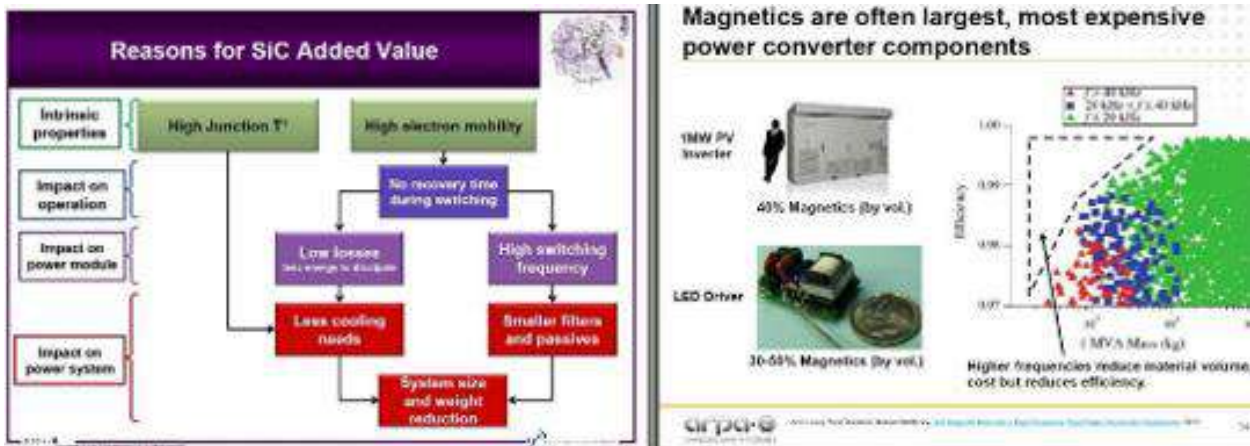

Figure 5: SiC require less cooling needs and smaller filters and passives, therefore reduction of system size and weight; today only magnetics impacts for 40 % (Source Yole Development Report – DOE report)

SiC added value in terms of power system size and weight reduction has a direct link with the cost of the solution. These effects are also valid in the industrial domain, even if not directly addressed in the WInSiC4AP project. SiC adoption makes it possible to have electrical vehicles with higher efficiency and power density, according to the roadmap of ECS for resource efficient vehicle point 1.6 [Power electronics (form factors, efficiency, automotive quality) for drive train and auxiliaries] the targets of which are:

- By 2020 mass production of EV as well as medium scale production of FCEV shall be established in Europe. In addition, conventional ICE (internal combustion engine based) vehicles will be largely transformed to hybrid concepts to achieve the European CO2 reduction goals: SiC can contribute by reducing 5% of CO2 emission and by 2-3% efficiency point.
- By 2025 mass production of a 3rd generation commodity priced EVs as well as mass market FCEVs are foreseeable and 15 Mio units accumulated will be on the road. Japan has announced industrialization of SiC-Inverters for EV/PHEVs in 2018 (e.g., Toyota): WInSiC4AP project results will help European industries to compete in the future market of e-mobility.

Similar targets are defined in the aerospace field (reported in EU, Clean Sky 2, ACARE and SRIA documents) in relation to higher performance airplanes including reduction of costs and environment impact. In particular, beyond 2020, new efforts should be employed to achieve the ACARE goals for the year 2035 and, on a longer perspective, the 2050 targets of a 75% reduction in CO2 emissions, a 90% reduction in NOx emissions and a 65% reduction of the perceived noise with reference to passenger aircraft engines performance of year 2000. Moreover, the challenging environmental and operating goals for a sustainable and competitive aviation sector set by the ACARE Strategic Research and Innovation Agenda (SRIA) and Flightpath 2050 require new aircraft technologies, including higher power density on board electronics and components able to nominally operate in relatively relaxed environmental conditions.

Addressed MASP chapters challenges in essential capabilities vs WP essential capabilities

MASP chapters challenges	WP essential capabilities
11 Semiconductor manufacturing, technology equipments and materials	6.4 Process Technologies for Semiconductor Process Differentiation
	6.5 Process Technologies for System in Package
	6.2 Equipment and Materials for “More than Moore”

SiC components are able to provide an answer to the needs of applications addressed. However so far, the inability to fully exploit the high temperature operation capability of SiC in a reliable manner is impeding to extend its use to the very critical targeted applications needing a long life time, full safety and/or functioning in a harsh environment and at higher frequencies than today. Eliminating water cooling, reducing global system weight is also a must. This needs brand new technology solutions to fulfil these expectations, which will be fully addressed by the WInSiC4AP Consortium.

Moreover WinSiC4AP relates also Smart System Integration Essential Capabilities addressing specific challenge and scope of that topic as better detailed in Ambition Section (cfr. 1.4)

1.3 Concept and approach

Concept: Silicon Carbide Technology toward innovative and reliable applications

The origins of the Silicon Carbide technology for electronics are at the beginning of the 20th century when SiC was used as a detector ¹in the first radios. In 1907 Henry Joseph Round produced the first LED by applying a voltage to a SiC crystal and observing yellow, green and orange emission at the cathode. Those experiments were later repeated by O. V. Losev in the Soviet Union in 1923². However for the first use of SiC as a Semiconductor we must go up to 1961 when it was first advertised as a breakthrough technology due to its higher temperature resistance properties compared to Si or germanium transistors³. Since that, big leaps have been made and research in Silicon Carbide has revealed more interesting properties in particular on high electric field withstand capabilities, which translates into a very low resistance when turned on, key for additional important steps towards more efficient converters.

At present, SiC penetration in PV inverters, as well as in specific niche markets (Windmills), is well established. However, from a global perspective, the SiC pervasiveness roadmap is far from stabilisation and needs further effort for demonstrating the additional benefits compared to silicon technology. Also the availability of SiC-based final products is still limited to prototypes and small-scale production, in that several technical challenges at the application level are to be addressed before a mass deployment.

In the recent times intense research activities to characterize the technology, demonstrate the additional benefits compared to traditional silicon technology, and to integrate the value chain from material and equipment suppliers (who have by now a nearly-ready supply chain for mass production) to the intermediate users, has been the focus of several research and EU-funded projects (e.g. “Last Power”, 2010).

This effort has allowed pursuing a significant cost reduction in the manufacturing of Silicon Carbide devices and it has enabled a more extensive distribution of the related know-how.

However, even if demonstrators have been developed in some cases, they all have been driven from the basic-technology point of view, trying to adapt the application to the specific characteristics of the device. **The WInSiC4AP approach is totally different and oriented to the market approach: start from the applications to address the underlying supply chain towards the requirements coming from the final-user across the system integrators** (Figure 6).

Moreover in the WInSiC4AP project concept research activities are focused around all the ingredients for new profitable products to be developed in a pan-European ecosystem.

In this context, the target of the WInSiC4AP project is to complement existing European know-how in SiC technologies focusing on the specific application value chain as showed later on in the S&T implementation.

¹ Dunwoody, Henry H.C. (1906) U.S. Patent 837,616 *Wireless telegraph system*(silicon carbide detector)

² Hart, Jeffrey A.; Stefanie Ann Lenway; Thomas Murtha. "A History of Electroluminescent Displays", <http://www.indiana.edu/~hightech/fpd/papers/ELDs.html> visited the 2nd of September 2015

³ Loran M 1961 Silicon Carbide Transistor, New High-Temperature Device *Wireless World* January 1961

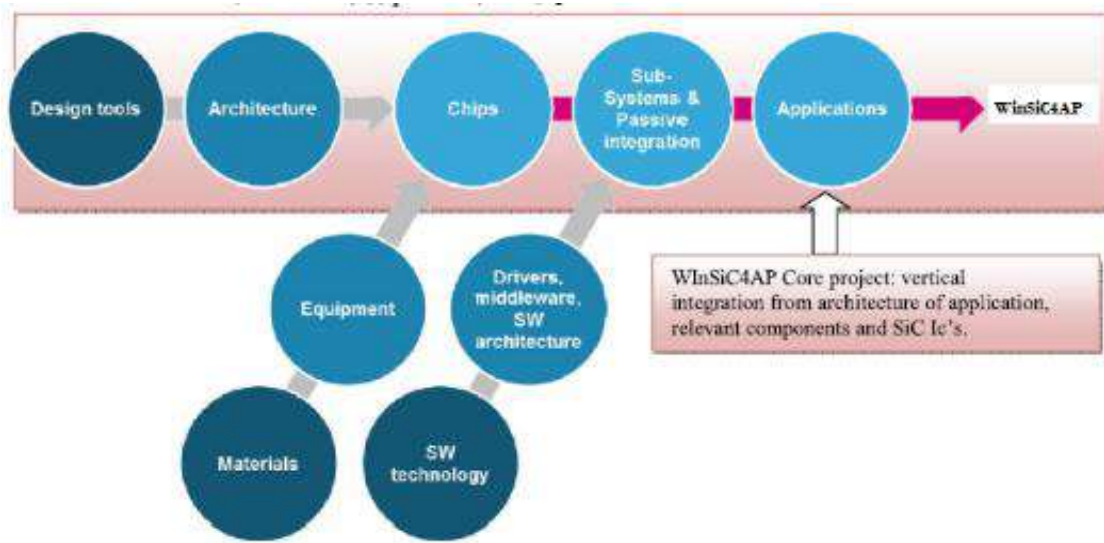

Figure 6: Simplified value chain: from chip design and architecture definition at system level to chips and integration in final applications. This is the core of the WInSiC4AP project.

Approach: vertical integration along value chain of key components and design methodologies

WInSiC4AP approach is to rely on the strength of a vertical approach by allowing the optimization of the technologies by fitting application requirements, by developing the full ecosystem and by tackling the relevant issues (i.e. the reliability and the EMC) inside the project scope. This will enhance the competitiveness of EU Semicons as well as of TIER1 and TIER2 down to the value chain as it will be showed later on, in the work plan description.

This approach will require a strong project steering effort that will be undertaken by DTSMNS and for technical-scientific coordination by STMicroelectronics.

The **Distretto Tecnologico Sicilia Micro e NanoSistemi (DTSMNS)** is within the 25 districts promoted by the Ministry of Education, University and Research (MIUR), in Italy in collaboration with the regions concerned, as provided by the National Research Programme 2005-2007. Participating in the DTSMNS, in addition to the University and the Region of Sicily, are leading companies in the field of micro and nano systems at the international level and major research institutes and industry associations.

DTSMNS Cluster has managed research and development and training large public-private projects that were funded by the Ministry of University and Research, like:

- ***PLAST_Ics - Electronics on Plastic Disposable Smart Systems***
- ***ENERGETIC - Technologies for Energy and Energy Efficiency***
- ***HYPPOCRATES - Micro-and nanotechnology and advanced systems for human health.***

STMicroelectronics (ST-I) is a global independent semiconductor company developing and delivering semiconductor solutions across the spectrum of microelectronics applications. Among the several Facilities, the STMicroelectronics Sites in Catania and Tours are Competence Center for POWER Domain going through a recognized leadership on SiC processes, design of discrete, modules and packages.

Today Catania hosts a pilot line for SiC in 4” that will be soon updated at 6”.

ST-I long-run experience in large JU projects (for example Project Last Power “Large Area silicon carbide Substrates and heteroepitaxial GaN for POWER device applications”) and participation to International Conferences on SiC (for example 16th International Conference on Silicon Carbide and Related Materials (ICSCRM 2015) -organized by CNR-IMM with 638 participants from all over the world) will ensure that the various broken-down activities are always triggered and synchronized with the objective of completing the

demonstrators within the project time-frame. A continuous risk analysis will be performed, with DTSMNS, from the very beginning to early commence the relevant mitigating actions where appropriate.

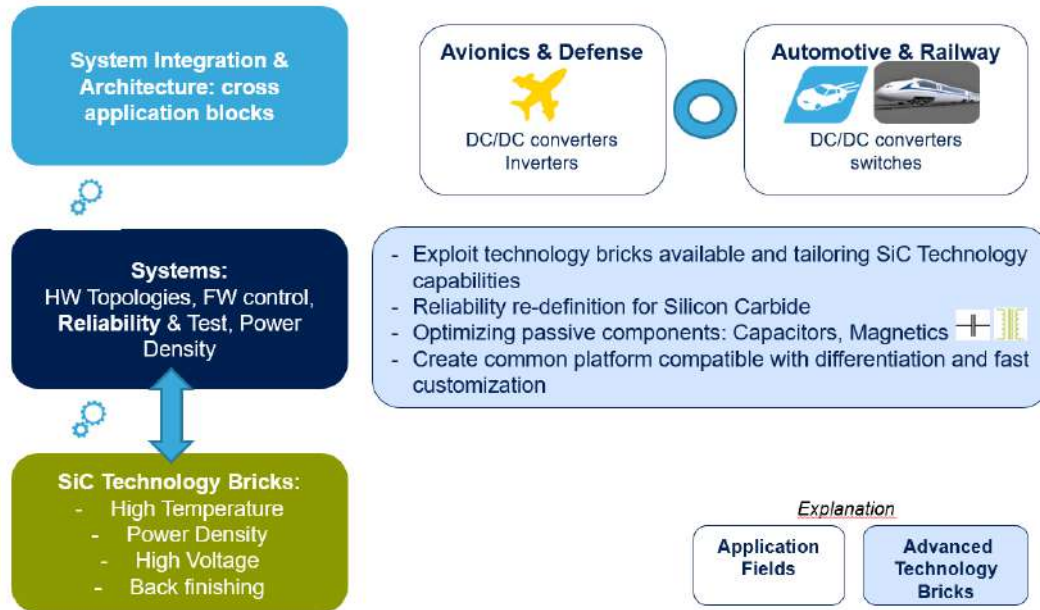

Figure 7: WInSiC4AP Project @ Glance with Objectives in Blue

This vertical integration will also require two major tasks to be done at the beginning of the project:

Applications requirement and technology development activities synchronisation

Starting from the specific requirements analysis that will be carried out during the first 3 months of the project, a synthesis of the common application blocks and requirements matching with technology development activities to identify a “Project Core” will be made.

Organization of the demonstrator value chain

The identified applications will be developed taking care of advanced topologies and architectures (as well as multilevel converters), all main components (MOSFET, Drivers, Power Module, passive components). Demonstrator test benches will be part of the activities.

The demonstrator value chain will help to ensure all the key elements for the demonstrator are built up and are made visible the contribution of each partner.

Figure 8 shows, as an example, the value chain from one of the selected application with main contributes and results obtained.

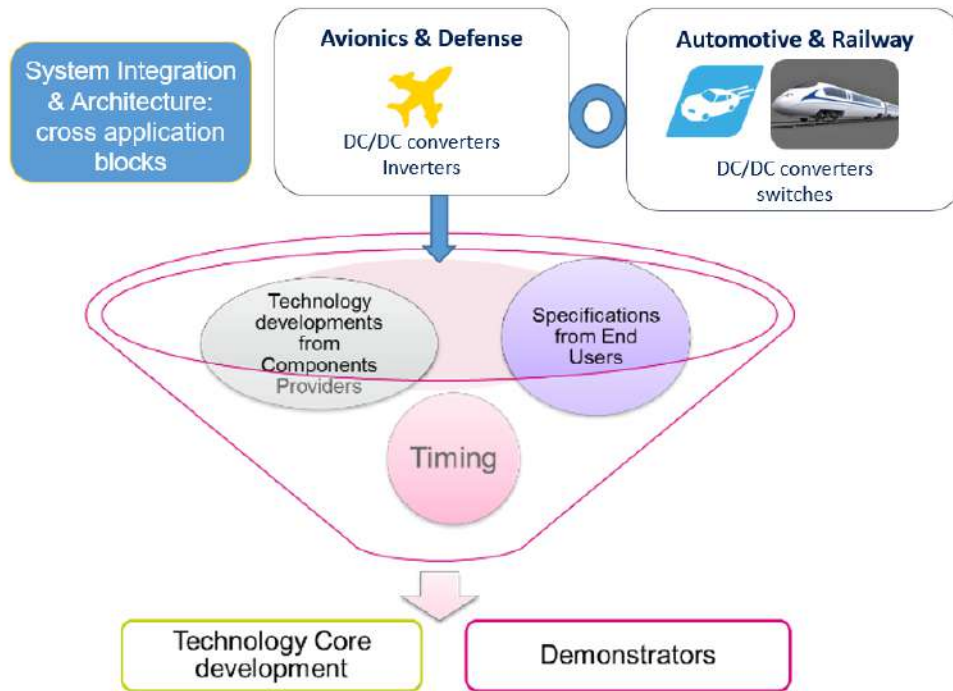

Figure 8: Matching specifications and technology requirements to focus on demonstrators

The above mentioned approach is translated in the work plan represented in the Figure 10 that will be broken down in details later in the S&T implementation.

- *As regards the positioning of the project and Technology Readiness Levels*

WInSiC4AP technology readiness level

WInSiC4AP project key applications and essential technologies addressed are on the range TRL3/4 and *the major objective is applied research, technology development and/or method/tool and integration, testing and validation on a small-scale prototype in a laboratory or simulated environment laboratory.* Moreover ambition is to have a complete validation to have a fast industrialization, after Project conclusion.

As above described WInSiC4AP is situated in the spectrum from “technology/component to system application” for the following demonstrators

1. On Board battery Charger for PHEV or BEV (VSCM)
2. Isolated DC-DC Converter for HEV, BEV and FC (VSCM)
3. Intelligent Power Switch (IPS-RA) (NEXTER)
(IPS-RA): High Voltage Power Converters (<10 kV) for embedded railway equipment's
4. Intelligent Power Switch (IPS-AA) (NEXTER)
(IPS-AA): AC & DC Intelligent Power Switch (IPS) for power distribution in avionics at module and component levels.
5. High efficiency Bidirectional SiC-based Power Converter for V2G/V2H applications in a nano/microgrid scenario (ED)
6. Inverter for Avionics Applications (ZODAERO)
7. LiPo Interface for Aerospace (DAC)
8. Engine Controller-Inverter for Aerospace (DAC)

WInSiC4AP will demonstrate technology/elementary bricks/systems basic functionality, critical test environments and associated performance for validation in laboratory environment. Performance predictions will be defined relative to the final operating environment (TRL4) to enable, at the end of project, subsequent

development phases in an operational environment reducing overall time to market of the delivered smart energy and smart mobility applications.

- As regards any national or international research and innovation activities could be linked with the project, especially where the outputs from these will feed into the project; describing for those activities how they complement (not overlap) with the present proposal;

National or International research and innovation activities linked with WInSiC4AP

The WInSiC4AP project is directly linked to the main past European funded projects for technology bricks development, but its approach is different.

In fact past project have been mainly focused to the value chain for Silicon Carbide chip developments and production as highlighted in the Figure below.

WInSiC4AP is represented in the purple box to highlight the different approach (Figure 9) and instead it complements some running projects as showed in the Table 1 below.

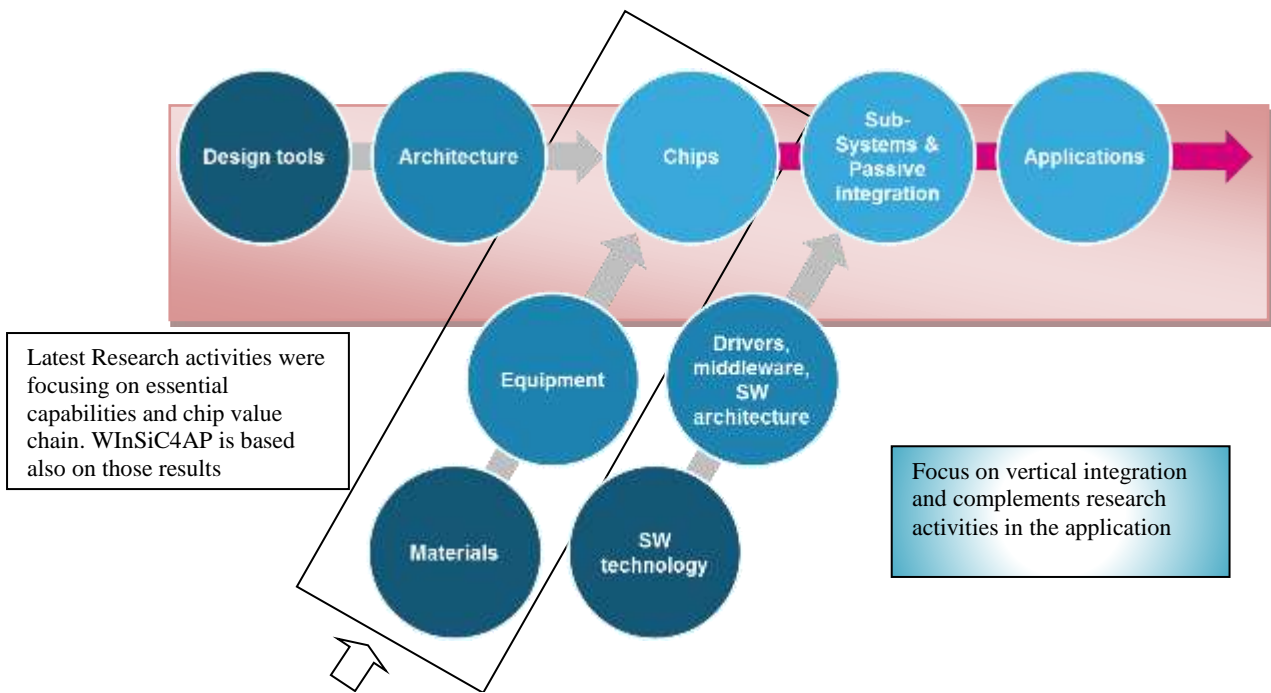



Figure 9: Previous research activities have focused on the value chain for SiC chip developments and production

In particular, the “Last Power” and “Thor” projects are used as the baseline of the project. Moreover, WInSiC4AP complements national and international research activities that focus on hybridization of ECS in HEV Vehicles (E3CAR), Photovoltaic Inverters (NEUMAN) and High Power Applications like SPEED.

WInSiC4AP is strictly linked also with other R&D projects running in the framework of TOURS2015 and particularly with “Sicrates” in continuity with “Thor”.

Other european and national funding programs are: IDEAS, ERG, E2SG (ENIAC JU), AMBITION POWER, ENERGETIC (national PON) etc., mainly targeting low TRL, where STMicroelectronics has acted as coordinator or partner.

Table 1 WInSiC4AP link and complementarity to some of the European and National Research activities

Addressed topic	Funding Entities	Project Name	Start Date	Amount	Content	WInSiC4AP break-through
Technology bricks: WInSiC4AP is enabled	 europa.eu	“Last Power”	2010-2014	4.5Meuro	SiC and GaN substrates	Complete SiC performing devices
		“THOR”	2008-2011	70Meuro	1st generation of DCDC converter based on phase shift technology at conventional switching frequency (80kHz).	In WinSiC4AP project, it will develop the 2nd generation, based on optimized topology (flyward expected) for high switching frequencies (250kHz) using SiC mosfets for efficiency and compactness optimization.
	France	FiSiC	2012-2017	10Meuro	Establishment of an industrial French chain about High Voltage (more than 3.3 kV) SiC Power Devices	Characterization of SiC devices at 1200V and 1700V

<p>Application: WInSiC4AP is complementary</p>		<p>E3Car Energy Efficient Electric Car</p>	<p>2009-2012</p>	<p>44Meuro</p>	<p>Heterogeneous integration of ECS and Module</p>	<p>To control and reduce complexity while enhancing functionality, safety, and robustness in smart electrified vehicles. Novel nano-electronic components and smart integrated and embedded systems for improved cost efficiency. Following up E3Car with a SiC power components in a smart actuator for automotive systems.</p>	
		<p>ENIAC JU/CALL 2011-1/296131 E2SG "Energy to smart grid"</p>	<p>2012-2015</p>	<p>33,5MEuro</p>	<p>Power device in smart grid application</p>	<p>New approach with SiC-based power converter for V2G/V2H applications in a nano/micro grid scenario</p>	
		<p>Italy</p>	<p>Italian MIUR PON R&C 2007-2013 PON01_00700 "Ambition power"</p>	<p>2010-2014</p>	<p>18,5MEuro</p>	<p>Components in Si, SiC and GaN technology.</p>	<p>The project will exceed first generation of SiC already studied in Ambition Power</p>
		<p>Italian MIUR PON R&C 2007-2013 PON02_00355_3391233 "Energetic"</p>	<p>2012-2015</p>	<p>20Meuro</p>	<p>Tecnologie per l'ENERGia e l'Efficienza energETICa</p>	<p>It will enhance bricks for demonstrator in new applications respect to ENERGETIC ones.</p>	

- As regards the overall approach and methodology, distinguishing, as appropriate, activities indicated in the relevant section of the work programme, e.g. for research, demonstration, piloting, first market replication, etc;

The overall WInSiC4AP project is positioned in the TRL 3-4 for research and demonstrators as it focuses on technology bricks, technologies for passive components or advanced packaging options driven by application requirement of products not yet on the market. Starting from WP on specs definition the overall Workplan includes technical workpackages dedicated to SiC FE/BE technology and workpackage to validate system demonstrators. The project consists of two pillars created to guarantee ECSEL/National cost and ESIF cost segregation as better explained in the paragraph 3.3 Consortium as a whole.

The work plan is represented in the Figure below.

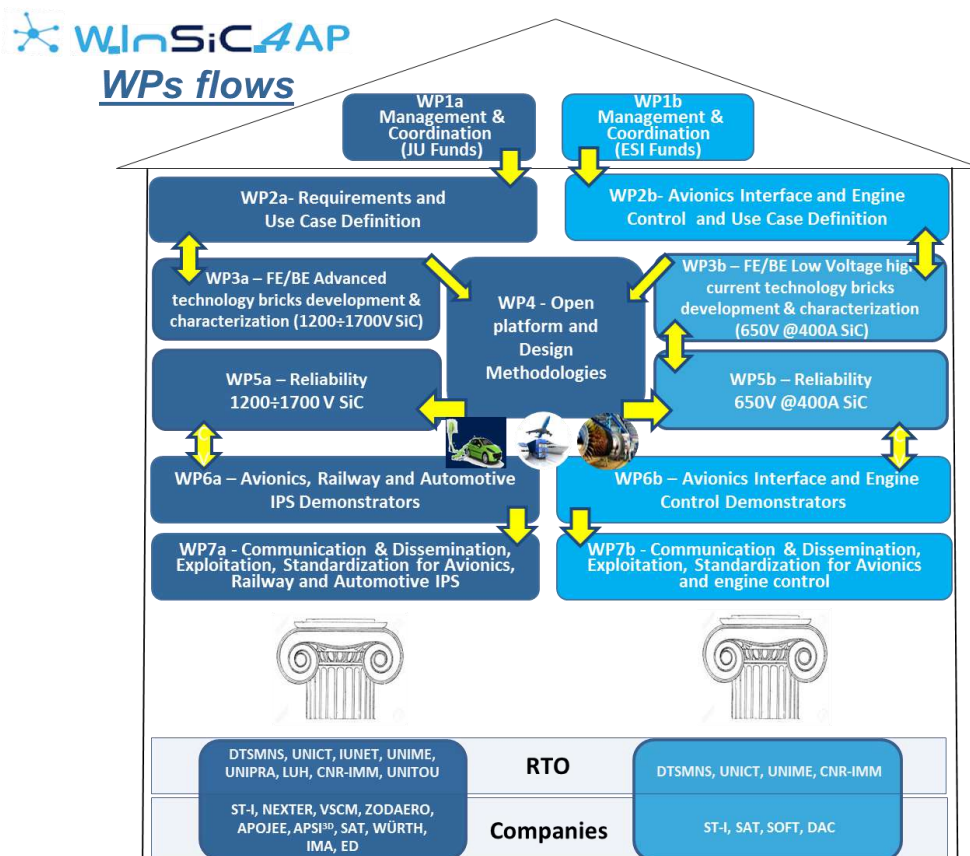

Figure 10: WPs structures and interconnections

There are no gender related aspects addressed in WInSiC4AP.

1.4 Ambition

Current Si-based converters existing on the market are designed at a maximum switching frequency of 80 kHz, this leading to bulky magnetic components which makes the layout of the system very challenging. This difficult mechatronic integration induce significant parasitic inductances that perturb the switches commutation and generate losses, ripple, overvoltage and EMC perturbation. Nevertheless, when such problems arise only at the debug time, designers are obliged to further slowdown the commutations frequency, thus increasing switching losses, reducing the conduction time and therefore the maximum available power. It is obvious that the passive component size can be reduced by increasing the switching frequency, but Si-based components have limited performances at frequency higher than 100 kHz, where commutation becomes the predominant source of losses which cannot be easily dissipated.

In case of DCDC converters for automotive applications, current efficiency ranges around 90-91 %, in a volume of about 800 W/L. Latest generation of DCDC converters has enhanced efficiency thanks to Si components improvements, but 93 % seems to be a physical limit, within a power density of 1 kW/L.

Further improvements can be made possible with the usage of components based on wide band gap semiconductors like SiC, which, thanks to their very low switching losses, can make the increase of the switching frequency easier.

However a simple Si-to-SiC replacement is not sufficient to justify the increase of costs of the semiconductor module: indeed, as these components are quite expensive compared to Si components, other improvements must be accomplished in order to justify them. The most effective approach is to redesign the complete architecture of the energy conversion in order to get all the benefits from the use of these components.

The project demonstrators will therefore be designed and prototyped on an innovative architecture aiming at reducing the size of the magnetic components, scaling down the output filtering and relax constraints on output MOSFETs, finally improving the overall efficiency up to 94-95 %.

Multi-level converters topologies will be also explored especially for high conversion-ratio applications.

1.4.1 Ambitions in key applications

WInSiC4AP main application scope is on automotive railways and avionics as it is one of the major markets of power devices expected in the next years. In this domain **Smart Mobility** and **Smart Energy** as key application will be addressed. As below detailed inside 1.4.1 paragraph, the key WInSiC4AP Consortium Partners who will drive the project ambition in the relevant key application will be VSCM, ED, NEXTER, ZODAERO and DAC as the applications partners.

These key application targets are reported in Table 2 with breakthrough goals.

Table 2 Summary of Ambitions in Key Application MASP Smart Mobility and Smart Energy

Demonstrator	State-of-the-art	Breakthrough
Battery charger for BEV or PHEV (VSCM)	On board battery charger 3,5 kW based on slow switching Si-IGBT-Technology. Compactness at 1kW/L and efficiency around 93-94%	SiC-Inverter, handling the SiC technology potential in case of fast switching (20KA/μs) and higher Tj in order to reduce losses and system volume / cost. Optimization of gate driver, commutation cells and DC Capacitor Link. Validation with 800V electrical machine and electric drive train performed by CAR Maker.

<p>DC-DC Converters for HEV, BEV and FC (VSCM)</p>	<p>Current generation of DCDC converter is improving thanks to Si components improvements, but efficiency of 93% seems to be a technical limit, within a power density of 1kW per liter.</p>	<p>Innovative architecture of DCDC converter, reducing magnetic components, reducing output filtering and constraints on output mosfets, within improving efficiency up to 94-95%.</p>
<p>High efficiency Bidirectional SiC-based Power Converter for V2G/V2H applications in a nano/microgrid scenario (ED)</p>	<p>DC HV-HV existing on the market based on silicon are too expensive and too big for the function they are supposed to provide. Major technical difficulties are remaining with current technologies: Si components (mainly IGBT) are limited in switching frequency (25kHz), inducing a design of very big magnetic components.</p>	<p>Bidirectional DCDC converter High voltage systems (450-850V) to low voltage battery (230-420V).</p> <p>It will be developed along with a bidirectional AC/DC converter</p> <p>5kW continuous power conversion cell compatible with parallelization (to provide a complete range of product from 5, 10, 15kW).</p> <p>98% of efficiency</p> <p>power density > 25kW/L</p>
<p>Intelligent Power Switch (IPS-RA) (NEXTER)</p>	<p>Energy management and distribution in rail domain is mainly achieved using electromechanical contactors and relays, and PLC . The use of intelligent power switches for the management and distribution of energy (voltage conversion, line protection, ..) will improve gravimetric and volumetric power density and the implementation of new functions.</p>	<p>High Voltage Power Converters (<10 kV) for embedded railway equipment's.</p> <p>Improvements expected:</p> <ul style="list-style-type: none"> -Increase the internal operational temperature range to 85°C (today limited @ 40°C outside (natural cooling) and 70°C inside the box) -Improve the Power Pack Volumetric power density by a factor of two. -Increase the voltage capability up to 3,3 kV using a series design topology
<p>Intelligent Power Switch (IPS-AA) (NEXTER)</p>	<p>The aircraft electrification increase to meet the power management requirements. In terms of energy distribution is planned to use bipolar HVDC power networks (+/- 270V). To protect and control this power networks, new intelligent power switches are required.</p>	<p>AC & DC Intelligent Power Switch (IPS) for power distribution in avionics. At module and component levels.</p> <p>Improvements expected:</p> <ul style="list-style-type: none"> -Gravimetric and volumetric power density of SiC IPS in the range 1,2 kV. -Packaging interconnections in terms of insulation -SiC Drivers integration inside the IPS module (different solutions will be analysed)

<p>Inverter for Avionics Applications (ZODAERO)</p>	<p>Actual More Electrical Aircraft power distribution architectures aims to increase the level of performances by using multirole power electronics. Actual power converters use Si-IGBT-Technology which makes them too big for the MEA to be competitive.</p>	<p>New 45kW multirole inverter for power distribution in avionics, embedding the following innovations:</p> <ul style="list-style-type: none"> -Use of SiC technology to reduce losses, volume of magnetic components -Intelligent driver providing control of dV/dt, dI/dt, embedding tunable quick protections and being capable of withstanding high temperatures -Optimized isolated power module embedding power transistors, drivers, current sensing, temperature sensing with a definition being deeply thought for its coupling to the cooling system -Integrated input and output filters with low volume and weight.
<p>LiPo Interface for Aerospace (DAC)</p>	<p>Digital interfaces existing on the market for aerospace applications and based on silicon are expensive, big and necessitate to be thermally conditioned since they cannot sustain typical aerospace environmental conditions.</p>	<p>Digital interface for airborne LiPo Batteries power supply and reload (50V, 400A)</p>
<p>Engine Controller-Inverter for Aerospace (DAC)</p>	<p>Digital interfaces existing on the market for aerospace applications and based on silicon are expensive, big and necessitate to be thermally conditioned since they cannot sustain typical aerospace environmental conditions.</p>	<p>Controller for Electric Engine (1-25kW), Outside Operating Temperatures (-50°C / 50°C)</p>

1.4.1.1 VSCM Ambition on key application by its target demonstrators

State of the art for power energy conversion and Associated Challenges.

Current Si converters (DC/DC or AC/DC) existing on the market are commonly designed at approx. 80kHz switching frequency, leading to quite big magnetic components that are difficult to integrate in the product because of their dimensions.

Passive components represent a large part of the product in term of price, volume and weight in energy conversion products, either for the conversion itself, or to filter the perturbations caused by the switches of the converter. As example, the DCDC converter developed by VSCM in THOR project where passive components take more than 2/3 of the product final volume :

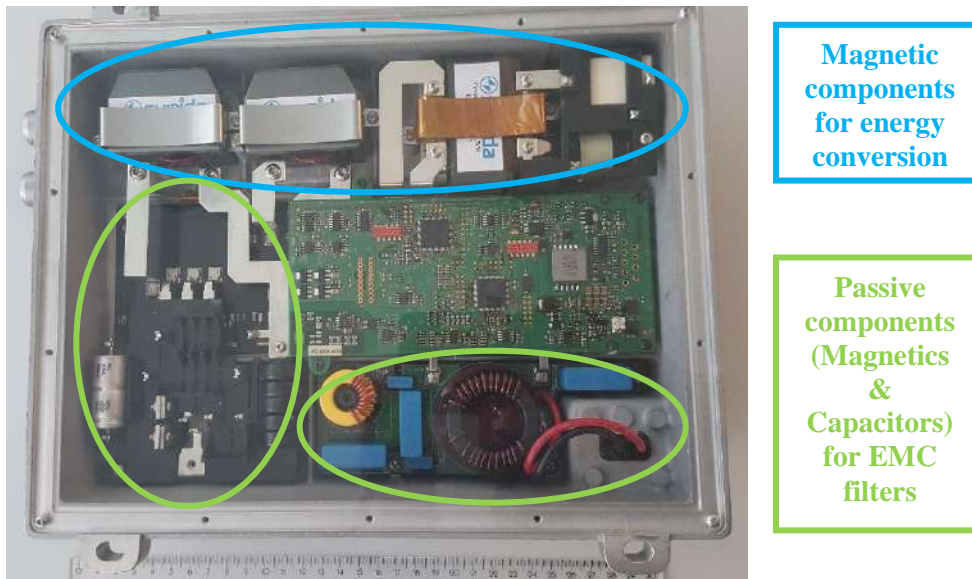

Figure 11: Example of application board with Passive components

This issue becomes more and more critical with the power increase of the product specification as passive component size is roughly proportional to the power transferred.

It is well known that increasing switching frequency will improve passive component sizing, but with current Si components, higher frequency than 100kHz causes an important increase of losses, that cannot be dissipated easily and that reduce dramatically efficiency of product.

State of the art for DCDC HV-LV converter

First generation of DCDC converters for automotive applications had efficiency of 90-91 %, and the volume of the packaging was about 800W/L. Current generation of DCDC converter has improved thanks to Si components progress.

THOR project (2009-2012) has largely contributed to the current DCDC converter development, based on these optimized Si components and an intensive work on the 3D packaging. As output of this interesting project, Valeo succeed to put the ‘phase shift DCDC demonstrator’ to a sufficient maturity level, and production has started beginning of 2016. But we have to recognize that efficiency of 93% achieved in this DCDC seems to be a technical limit, within a power density of 1kW per liter. A better result was obtained in the 2nd phase of THOR project, with a 94% efficiency DCDC converter (LLC topology), but the output filter was so big and costly that the product had no chance to come on the market.

State of the art for OBC On Board Chargers :

The first generation of On Board Chargers efficiency was also very poor: 91-92%. In 2012, a new generation has been developed, based on knowledge from telecom converters. This topology is called LLC resonant converter, is very high efficiency (up to 95% at medium power), but very difficult to design and tune for a repetitive and robust function. End of 2013, Valeo started the mass production of this new platform in the Volvo V40. But High Voltage components were not available as automotive grade, and the power was limited to 3 kW. The current platform has evaluate now to 100% automotive grade components, with full compliance with worldwide grids and is rated to 3.5kW.

This product is today the reference of the market for its efficiency and compactness (1,1kW/L), is in production for BMW, and we gain businesses also with French and Chinese OEMs.

In 2025, VSCM evaluates a market share of 25%. This is mainly due to the excellent product we can propose and the fact that our competitors were late on technology. But competitors worked hardly since the 2 past years on 3,5kW OBC and we see our advance decreasing.

Solutions and innovative breakthrough to improve power energy conversion

To improve these converters, usage of **wide band gap components** like SiC is obvious thanks to their capability of switching without losses; it means that with SiC components, increasing switching frequency becomes easy and as direct consequence, reduction of **passive components** will be important.

This is almost not sufficient if we want to use these components for highest benefits. Indeed, as these components are quite expensive compare to Si components, we must find out other breakthrough in order to justify interest of use. The most accurate approach is to rethink the complete **architecture** of energy conversion in order to get maximum benefits from these SiC components. In parallel to these major improvements, an **optimized control** of the converter is needed to control the switches commutations and reduce constraints on component specifications such as EMC filters, capacitors ripple, switches losses. In addition, an important work on mechatronic integration and technologies is needed: integration of components in the pcb to reduce size and interconnections, optimization of component **cooling** to increase efficiency and robustness...

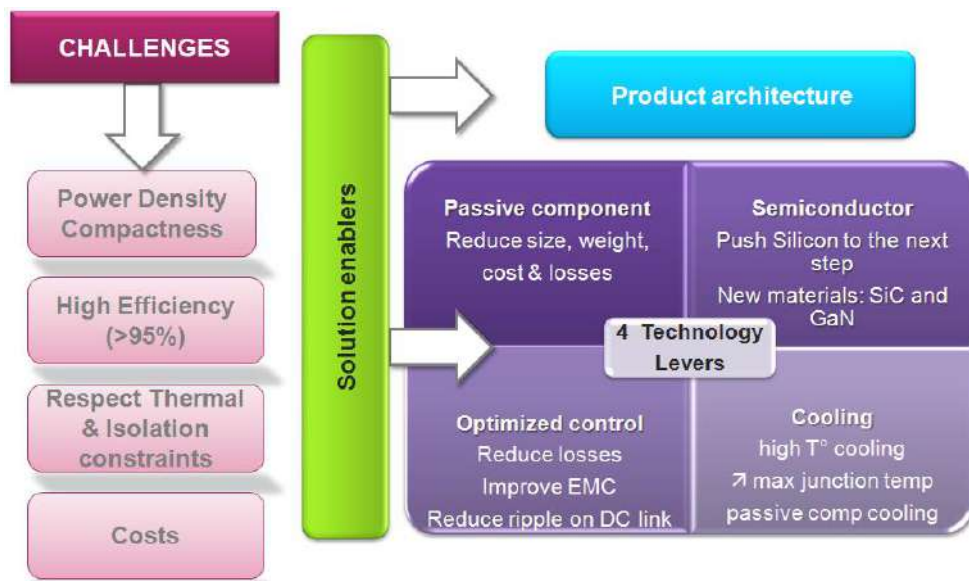

Figure 12: Architecture topology in power conversion

Application to DCDC converter

Since mid of 2014 VSCM is evaluating and searching new possible topologies to address next DCDC platform having in mind the weaknesses and lessons learned from previous projects. Flyward conversion topology was defined and patented. The proof of concept is now confirmed, based on simulations and a rapid mockup.

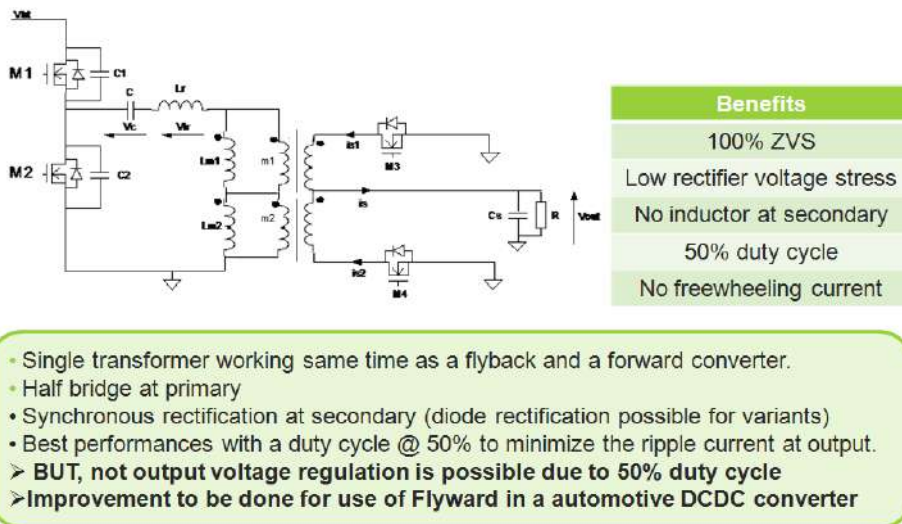

Figure 13: DC/DC converter topology

In WInSiC4AP project, VSCM wants to apply this architecture for an automotive DCDC converter application (mockup for concept proof was just a part of a converter as shown above). Some adaptation will be needed (add of a pre regulator) in order to be able to provide an output voltage regulation. VSCM will verify the pertinence of this new topology for high switching frequencies using SiC components, reducing magnetic components, reducing output filtering and constraints on output mosfets, within improving efficiency up to 94-95%.

Breakthrough also is needed to integrate more close to the switches passive components (magnetic and capacitive). Reduce stray inductances and skin effect due to high output currents and high frequency switching: innovation in pcbs and dies integration.

Valeo will deliver a demonstrator in **WP6a task 6a.3** integrating components developed in **WP3a** by skilled partners in WInSiC4AP project (capacitance, inductors, transformers, switches...), based on specifications elaborated in **WP2a task 2a.2**. Modelling and reliability of these components will be achieved in **WP4 and 5a**.

Application to On Board Chargers (OBC)

Thanks to WInSiC4AP VSCM will prepare the next generic platform for OBC, to maintain its market share on 3,5kW chargers, and also to adapt to market needs evolution:

One of the main limitations of the BEV is the autonomy. Thanks to impressive progress in battery cells technologies and manufacturing processes, power density is increased, and price of kWh is decreasing. Some OEM wants to take the opportunity to integrated more capacity in the vehicle, in a given volume and for more reasonable cost. Current average capacity is about 25kWh in a B/C segment vehicle, in 3 to 5 years, average capacity will rise up to 40kWh. It means that the charging time will increase in proportion: from 8-10 hrs today to 11-13hrs in the next years. This charging time, already considered as excessive will not be affordable in some years. Specifications for OBC are then moving to 7kW power.

According to the results of WInSiC4AP VSCM will have the opportunity to take the lead on this new market with an optimized solution (dedicated design for 7kW, new component technology reducing losses and passive component size) , in order to be the market leader on a mature market :

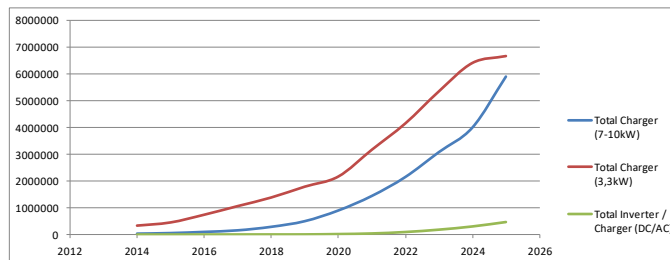

Figure 14: Worldwide market for chargers (in units)

This new platform will be developed in WInSiC4AP collaborative project starting with a comparison of existing topologies, in order to select the most appropriate one for this new power and to be compatible with higher witching frequencies and SiC components. For the detailed design phase, a close collaboration with ST on SiC components will be needed and their innovative packaging solutions will be an important topic. Passive components will be completely redesigned, it will required several loops of optimization, in link with the mechatronic integration of the product and the associate thermal simulations.

With these new technologies developed by consortium in **WP3a**, VSCM will rise the power density of the charger demonstrator up to 1,5kW/L. This 7kW On Board Charger is the deliverable of the **task 6a.4** out of the specifications issued in **task 2a.1**.

Project Demonstrators	Operative Voltage	Imax	T	Ambition
DCDC Converter for Automotive (VSCM) <ul style="list-style-type: none"> • 1/2 volume & weight passive components • high switching frequency 200-250Khz (80kHz currently) • efficiencies up to 95% (91%) • 1,2 kW/L (0,8 state of the art) 	170-450V input (240-420V today) 10-16,5V output	230A (180A now)	Cooling temp 65°C	Reduction of magnetic components to increase compactness and overall cost with high efficiency
Powerfull on board charger for Automotive (VSCM) <ul style="list-style-type: none"> • high switching frequency, • higher charge speed 7kW (3,5kW), • high efficiency 96% (94%), • higher power density 1,5kW/L (1,1kW/L state of the art) 	Input : worldwide grid 170-450V output (200-420V today)	32A	Cooling temp 65°C	Reduce charging time, within increasing power and efficiency, and reduce size of OBC for affordable cost.

Reliability for automobile demonstrator DCDC converter & On Board Charger.

Reliability is well known as major criteria for automobile applications. This explains the need of specific components class, and specific qualification plans for electric components in the cars.

But with electric and hybrids applications, some new requirements are growing: with the example of US regulations that requires 15 year of warranty for electric components dedicated to HEV or EVs, most of the OEM (even in Europe) are following the trend, and are requiring this level as standard. 15years of warranty means 300 000 km (for conventional vehicles, warranty is due 3 years, and durability is calculated for 150 000 km.

The function itself of the component is also to be taken into account. In conventional vehicle, ECUs are used approx. 4 000 - 6 000 hrs all along the life of the car. For a charger this value rises up to 40 000hrs of use (with an average use of 8h each day during 15 years). The charger is use only during the charging time at night. During this charging sequence 12V consuming auxiliaries like waterpump, fans, dashboard etc. could be used, so that 12V battery must be fed. The DCDC HV-12V converter is then used during charging. But is also for sure needed during driving phases. Consequently, this DCDC converter shall withstand more than 50 000 hrs of function. 10 times the conventional requirement!

It is then critical to introduce reliable and durable technologies, so that SiC components, packaging solutions, passive component... shall be tested and validated in endurance and their failure mode have to be understood in detail.

That is why VSCM will be involved in **WP5a**, doing the link between customer requirement and mission profiles, component requirement in term of reliability, and integrating results of reliability test of each components into the complete system reliability computation. With help of APOJEE, endurance tests of complete system will be done in order to validate reliability results at system level.

Market of hybrid and electric vehicle is growing and analysts see a important acceleration in 2020. To catch up the business, VSCM has to propose rapidly a product with clear competitive advantages (cost, packaging volume, efficiency) as competition is very intense and a lot of new players from industry are trying to enter the automotive game.

Threats about DC/DC converters business are to not be ready or sufficiently competitive for 2020 market :as mentioned before, VSCM suffers today from bad competitiveness level with current product, and risk is high not to be anymore in the race for this kind of products later on.

Main key market players are for sure conventional players, but the fear comes from new players like Delta company, well implanted in industrial conversion since years and thanks to their high purchasing volume in power components and localization in China, able to propose very competitive price. Other type of competitors are Japanese suppliers of components that are entering the market with full product proposal (Nichicon, Panasonic, Hitachi..)

WinSiC4AP project will then help a lot VSCM to recover a good competitiveness on DC/DC converter and for On Board Charge to maintain market share and be the leader for new growing business of 7 kW chargers.

1.4.1.2 NEXTER Ambition on key application by its target demonstrators

Testing and validation of SiC inverters

Conventionally, converters are tested with test benches build from several standard bricks such as DC power supply, motor emulator, battery emulator, mains emulator.

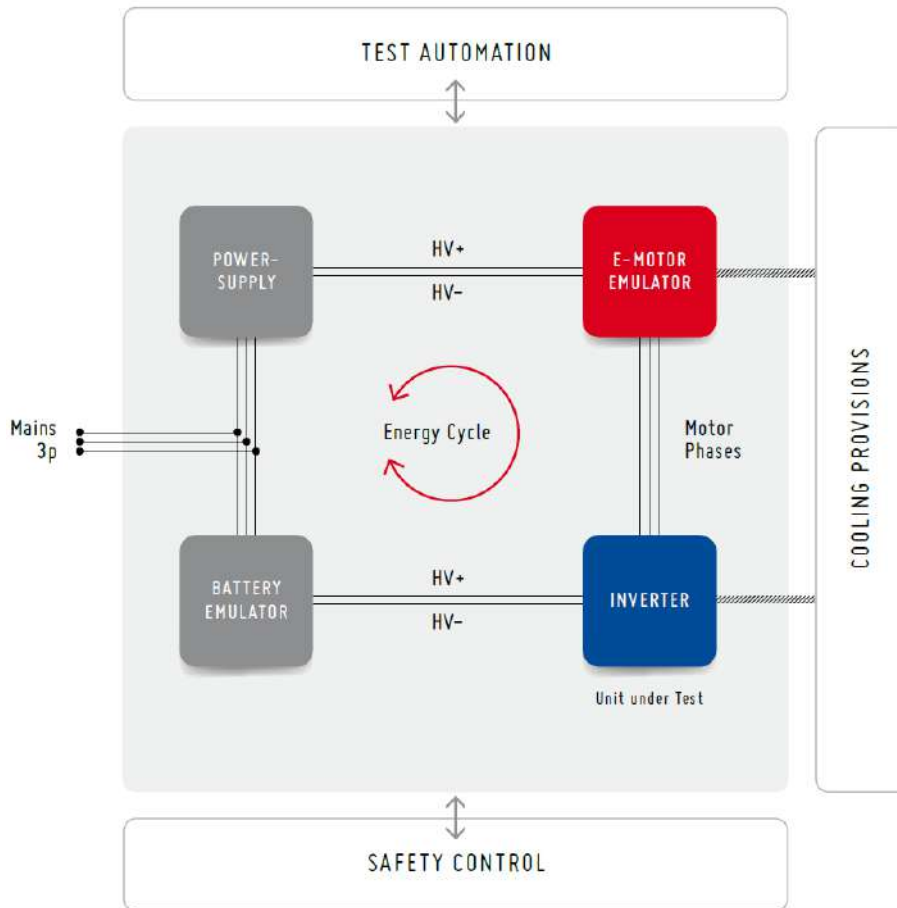

Typical System Topology for the testing of Drive Inverters

Figure 15. Typical System Topology for Drive Inverters testing

This approach has several limitations:

- energy is exchanged through several subsystems made by various suppliers. With this architecture, inter-regulation problems can occur and therefore decoupling power filters and/or limited the bandwidth for the control loops must be used
- subsystems interconnection result in high parasitic parameters (parasitic inductance of cables between cabinets, or common mode parasitic inductance of the test bench). The system under test being defined for a totally different environment, as a matter of facts, is never tested in real conditions.
- the subsystems come as black-boxes: as a consequence a failure might require several days or weeks to be fixed due to the limited availability of spare parts.
- the set-up of a test sequence on the test bench is difficult and long, due to the needed interaction between the several subsystems.
- but even more important only one single device can be tested in a single shot

The approach proposed here by APOJEE is radically different and is able to efficiently test several devices in parallel, in particular for end-of-production-line testing.

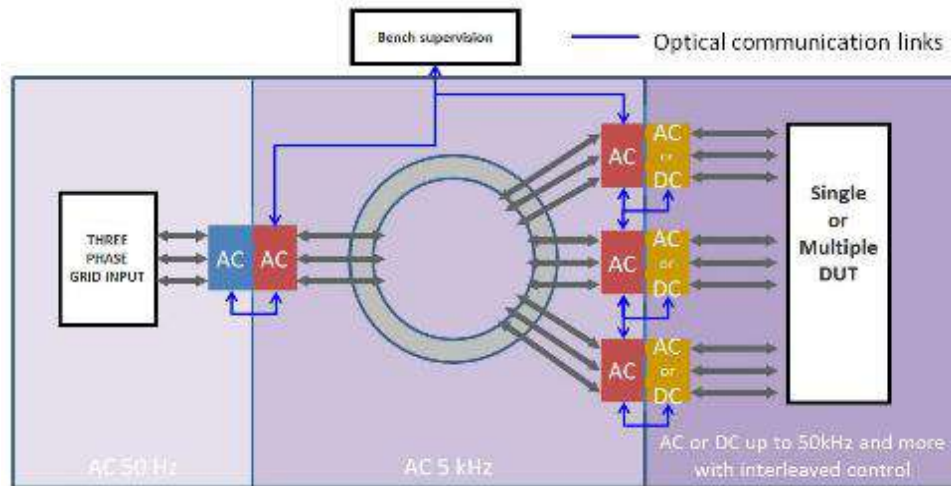

Figure 16: architecture of test bench

- The heart of the system is a very robust SiC inverter (on the left) providing the grid connection to the bench and connected into a cell designed to get ultra-low common mode parasitic capacitance
- Several devices under test (DUT) are connected into the cell, clustered into racks (the simplest option could be one AC and one DC, four AC and two DC being possible for example to test a four wheel drive configuration with one electric motor per wheel). The energy flow is internal to the system, allowing to simulate situations much more representative of the reality
- The communication links are isolated through optical fibers, in order to have a negligible EMC effects coming from the power side.
- Several racks can be grouped to compose a test bench, working in interleaved mode allowing an effective switching frequency in the range of MHz and therefore a bandwidth of 50 kHz on the outputs. This arrangement has also others advantages because in case of a failure, the time needed to exchange a failing rack could be of less than one minute because the switch off of one cells does not affect the others.

In this context the application identified as IPS-RA has been identified in an AC Power generation station (400V AC 50 kHz) for ancillaries in railway transportation: tramway, metro, regional lines, with two options:

- AC conditioning (100 kVA)
- Pumps (hydraulic, pneumatic circuits for braking or open doors (20 kVA)



SiC Electronic Smart Systems key applications enclose trains:

- Power Conversion in electrical traction (auto, trains, aircraft, industrial motor drivers)
- DC-DC conversion for battery charging and DC distribution (auto, trains, aircraft)
- HVDC in Grid

Currently on the railway transport sector, the issues are mainly on the drivetrain system level. Inside the Project one of the goal is to realize a significant gain on the entire drivetrain system level and to be able to redesign the entire conversion chain to reach a sufficient level of integration addressing the following challenges:

- High operating temperatures up to 250 °C
- Higher switching frequencies
- reduction in the weight /volume of the converter
- Voltage up to 10 kV
- Chip operate under a temperature of 250 °C
- Have a switching frequency: 2 kHz and >15 kHz

The introduction of Wide Band Gap (WBG) components is expected to reduce the overall cost of the traction function, to reduce its weight and dimensions with increased reliability. For the rail sector, the proposed applications will involve WBG intelligent switches.

The architecture requires the implementation of a topology with several switches in parallel and in series.

Intelligent Power Switch (IPS-AA) (NEXTER)

IPS-AA demonstrator will be used as an SSPC in AC (115V/220V) or HVDC (270V/540V) power networks.

- Power Part: the Figure presents the power part of the actual IPS with the following characteristics:
 - Bipolar IPS from NE : “Common source topology”
 - Use 8 Infineon CoolMos Power Switches: 650V/30 A: 45 mΩ IPB65R045C7.
 - Address 270VDC (+/-135VDC) Power Networks, embedded on aeronautical platforms

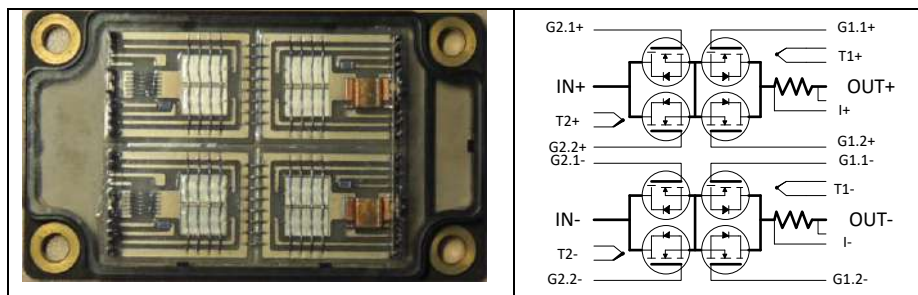

Figure 17: IPS without Gate Driver, from NEXTER Electronics

Broadening the range of products marketed by NEXTER integrating IPS (Intelligent Power Switches) in air-land areas, mainly in the railway and aviation segments. Improvements on the Power density are expected by the implementation of IPS HV and VHV SiC technology monolithic or hybrid versions, non-available on the market today.

The Figure hereafter presents the two topologies of IPS expected, to test the IPS-AA.

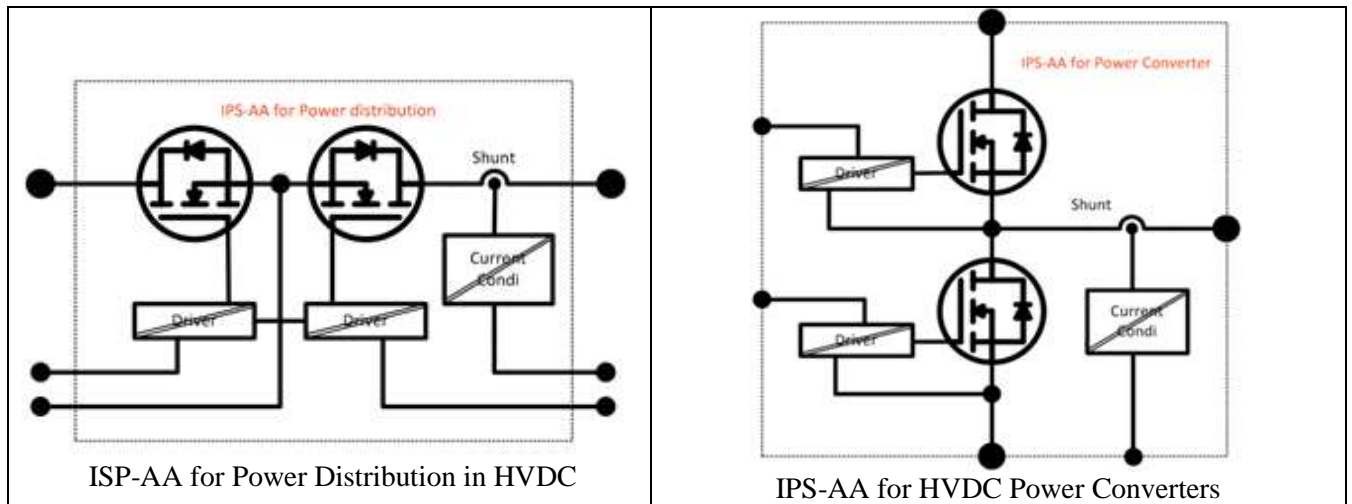

Figure 18: Intelligent Power Switches Topologies

On both topologies the final objective is to integrate the drivers and current conditioning inside a power module.

Driver Part : Two versions of control board are expected on the frame of WInSiC4AP:

- V1: Mockup implementing the global functionality. With gate drivers realized outside of power module, and using discrete components.
- V2: More integrated prototype implementing the gate drivers inside the power module (on the same dimensions of mockup).

Improvements expected into WInSiC4AP project:

- Gravimetric and volumetric power density of SiC IPS at component level (1,2 kV)
- Insulated Current measurement integrated into the IPS component
- Insulated Drivers integrated inside the IPS component

1.4.1.3 ED Ambition on key application by its target demonstrators

High efficiency Bidirectional SiC-based Power Converter for V2G/V2H applications in a nano/microgrid scenario

Enel Distribuzione (hereafter ED) will coordinate and lead the implementation of an AC/DC bidirectional converter that could be used for AC and DC nano/microgrids application, in order to promote the integration of local assets (DER, Storage, EV charging stations) with the AC electricity grid and simultaneously optimize the operational expenses of small-medium enterprises during their expected transition towards electric vehicle fleets. This is a necessary equipment to foster DC and AC nanogrids as useful tool to foster higher percentages of renewable sources in national energy mix, in line with EU 2030 Energy Strategy, particularly with regards to the expected transition towards de-carbonized transport.

In a fast evolving energy business framework where decentralized resources are becoming widely adopted and both EVs and residential storage approach their market feasibility, DC nano/microgrids might find become a sustainable and interesting alternative for emerging markets where the conventional AC grid is either obsolete or unreliable. The bidirectional AC/DC converter developed within this project will be the state of the art of bidirectional conversion systems, allowing smooth integration of EVs and residential storage into DC nano/microgrid as well as the bigger AC grid system or AC nano/microgrids.



ED, in combination with ST-I and IUNET will develop the system architecture, system requirements and draw out the possible detailed use cases for this subsystem.

Enel, leveraging its experience on DC charging systems for EVs, will coordinate the design and implementation of the system by using the state of the art technology of Silicon Carbide power transistors, provided by STMicroelectronics.

The system implementation will be built on top of the ongoing cooperation at industrial level between ED and STMicroelectronics (ST-I) for what regard the SiC-based power converters, of which state of art is an unidirectional implementation is currently being engineered for ED's EV fast charging stations targeted for deployment at national level within 2016-2017, where the ED Fast Recharge Plus product will be used (see Figure below).

Enel Fast Recharge Plus

High-speed EV charging on highways

Outputs: **CCS, CHAdeMO, Type 2 @ 43kW, Type 2 @ 22 kW**
First Live Demo February 2015

10/05/2016 All rights reserved, Enel SpA



Full recharge in less than **20 minutes**

Up to **3 EVs** simultaneously charging



Enel's **Smart Meter** inside





Figure. 19 State of the art for SiC based EV charging products

In principle, the bidirectional power converter could be used as part of V2G/V2H (Vehicle To Grid / Vehicle To Home) electric vehicles charging product and installed in DC nano/microgrid scenario as well as AC nano/microgrid scenario. In the Figure below the former scenario is represented, using the bidirectional power converter being developed in this project.

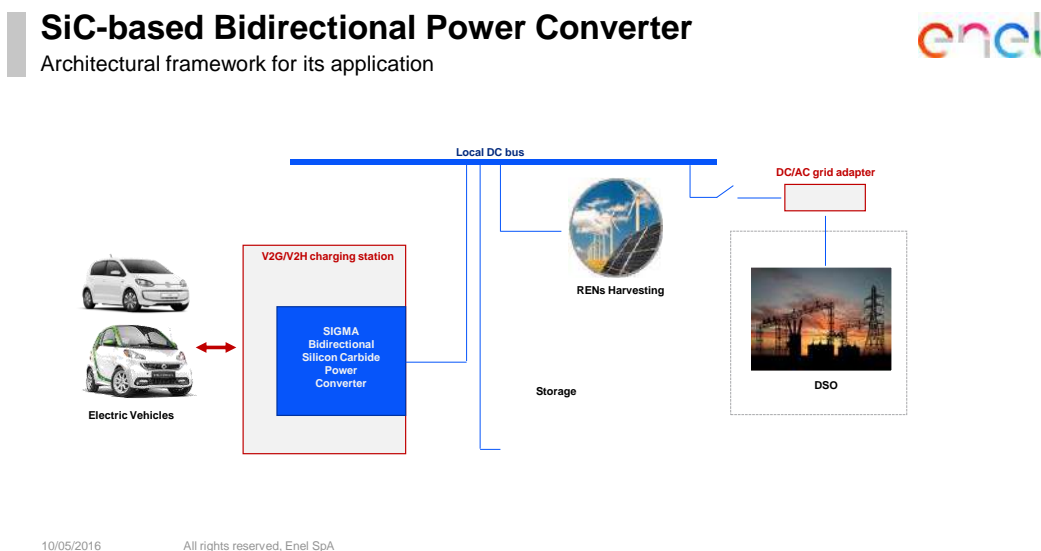

Figure 20: Possible application of SiC bidirectional power converter

A lab-level bidirectional power converter based on STMicroelectronics' customized Silicon Carbide power modules will be developed by ED jointly working with a specific subcontractor which will support ED for the design validation, assembly and testing phases. Functional and reliability tests will be performed at lab level on the power converter, in order to validate its usage in product level V2G/V2H EV charging stations to be installed in combination with decentralized RENs installations and local electrical storage. Functional validations will be performed targeting the scenario depicted in Figure 20.

ED will run the pilot by leveraging the contribution of IUNET at system specifications, scientific dissemination and system validation and STMicroelectronics for power modules customization, testing and supply. Once the design will be completed, lab-level validation will be conducted interfacing the power converter with EV simulator on one side and a DC bus (storage input / PV output) on the other side.

V2G/V2H markets are expected to grow in the near future, due to the uptake of EVs at mass rollout, as well as DC/AC-based nano/microgrids.

The high-efficiency bidirectional power converter developed in this project will be at the core of this class of products and will enable new combination of value added services delivered by ED to its customers in the medium TRL range (3 to 5 years).

1.4.1.4 ZODAERO Ambition on key application by its target demonstrators

Inverter for Avionics Applications

A significant increase in the power demand for the next generations of aircraft is expected. with total installed electrical power up to 200 kW because of

- Electric Flight Controls, Air conditioning, More Electric Landing Gear, Deicing systems
- Electrical Energy Distribution, Equipment's for a more Electrical Engine: Lubrication & Cooling pump
- Smart actuators for variable Geometries, nacelle anti-icing, thrust reverser EMA's, Power & Fuel Pump and signal harnesses.

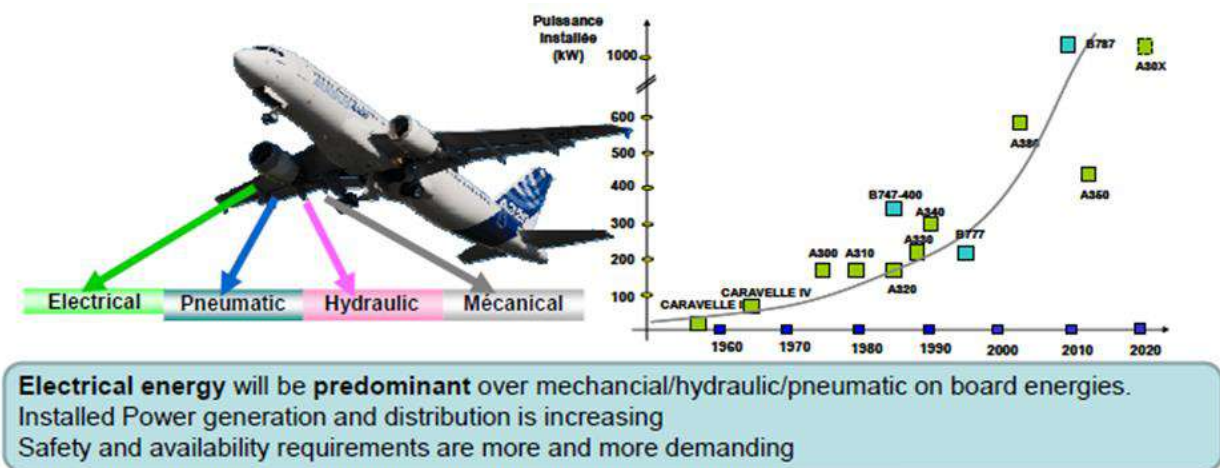

Figure 21: Evolution of power demand through time on aircrafts

Key requirements are:

- increased reliability of electronic equipment
- increased power density of components
- reduction in volume and weight,
- increased efficiency
- increased operating temperature: from 150 °C to 200 °C (to work in the engine compartment)

ZODAERO will develop a 45 kW multi-purpose power converter, based on a six switch topology able to perform different functions:

- to drive a speed-controlled a synchronous motor;
- to drive a position/speed induction motor;
- to provide a 115V AC/230 V AC 3 phases network (400 Hz) from the HVDC network (DC/AC converter);
- to provide a HVDC network from AC network or from ground power supply (AC/DC converter).

Main expectations from ZODAERO power converter are the following:

- Nominal input voltage 540 VDC, maximum up to 900Vdc
- Output voltage (depending on the mission) from 115Vac to 230VAC
- Output power: 45 kW
- Forced air cooling
- Ambient temperature close to 100°C
- Switching frequency >20kHz
- Efficiency greater than 98%
- Low volume/weight in comparison with Si-based IGBT inverters.

1.4.1.5 DAC Ambition on key application by its target demonstrators

LiPo Interface for Avionics

LiPo is the abbreviation of very slim, extremely lightweight batteries based on the Polymer Lithium Ion chemistry. This can be considered the highest energy density storage system currently in production. Several applications are arising recently, for airborne LiPo weight features is out of topic and day by day improving due to LiPo technologies; interface to control LiPo still remains an open issue, since typical heavy weight ground recharger units is the only device retrievable from market. A new airborne light device will enable new opportunities for avionics, in order to control charge status, recharge and optimize power output, due to typical LiPo functional features. In this case, also ambient temperature, pressures, vibration and acceleration must be taken in account in order to afford airworthiness safety requirements for airborne equipment.

LiPo Interface must be connected between the battery pack and recharge system (i.e. fuel cell system or other); this component is intended to recharge the batteries as soon as they reach a certain programmable threshold. Airborne battery packs can be multiple, for multiple purpose and may have different characteristic required (and consequently power absorption in terms of current/voltage and timing). Output voltage and LiPo charge status are parameters to be controlled in order to optimize power supply.

The basic requirements are high reliability, low weight and withstand extreme operating conditions (OAT: -50°C to 50°C). Reference voltage is between 100-200V, the maximum current is 400 A, the maximum temperature reached for the equipment is 250 ° C; as critical condition minimum operating temperature is -50 ° C and 6 g accelerations during flight operations; crash landing condition is 9g for equipments.

In order to fulfil the above requirements, a deep investigation will be carried out starting from the behaviour of selected power devices, the subsystems and the whole recharging system (UNIPA). Particular care will be given to the design and implementation of an intermediate demonstrator, capable to exploit the capabilities of the selected power devices (made in SiC) as well as the suitable gate drivers and the needed control section. This intermediate lab test-bed will be designed with several built-in sensors, not necessary in the final prototype, in order to give a deep insight for an early performance evaluation of the most important subsystem. In particular military enabled components will be used and military temperature range will be tested. Moreover acceleration sensors will be embedded, thus enabling the subsystem to carry out shock test for avionic purposes.

Engine Controller-Inverter for Avionics

Airborne electric engine can be suitably chosen as Brushless DC electric motors, due to their simple mechanics and controllable features; these devices are also known as electronically commutated motors (ECMs, EC motors), asynchronous motors that are controlled and powered by a DC electric source via an integrated inverter/switching power supply. The inverter produces an AC electric, not necessary a sinusoidal waveform, but rather a bi-directional current with no restriction on waveform. Additional sensors and electronics control the inverter output amplitude and waveform (and therefore percent of DC bus usage/efficiency) and frequency (i.e. rotor speed).

The electric engine controller/inverter must so be demanded to a device that is located between the power sources and the engine connection group; it is also connected to the signal receiver for command inputs. The purpose of this component is to modulate the power to provide to the engine in relation to the signal coming from the pilot via the receiver/flight control system. Model scale aircrafts for entertainment usually are equipped by DC controllers but these non-professional applications are limited in power (current/voltage) and control features; commercial inverters for general industrial application even if capable of high power control are limited by the heavy weight, not suitable for airborne applications; more over operating conditions (OAT: -50°C to 50°C). Vibration and accelerations during flight operations complete the list of basic requirements to comply in order to approach airworthiness and safety condition for flight equipment.

The basic requirements are high reliability, low weight and withstand severe operating conditions.

Voltage is between 100-200V, the maximum current is 400 A, the maximum temperature for the equipment is 250 ° C; the minimum critical temperature is -50 ° C. In terms of loads, 6g accelerations during operations and 9g for crash landing are applicable. The rated power are included in the range (1-25kW).

Also for the controller-inverter, the stringent requirements suggest the design and implementation of an intermediate laboratory test-bed in order to study the capabilities of the most important parts of the system such as SiC power devices, their suitable drivers and the logic control subsystem (UNIPA-DEIM). This intermediate demonstrator will be equipped with several extra sensors, not necessary in the final controller-inverter, in order to test the performance of the subsystem bricks and conduct an early investigation on potential weaknesses both at devices and board layout levels. In particular military enabled components will be used and military temperature range will be tested.

Voltage and current sensors will allow the test of electric performances while the design will also let to vary the working frequency in order to study the behaviour of needed passive components while exploring the maximum attainable power density in order to get the minimum overall weight. Moreover acceleration sensors will be embedded, thus enabling the subsystem to carry out shock test for avionic purposes.

1.4.2 Ambitions in essential capabilities

To enable the key domains of Smart Mobility and Smart Energy applications, **essential capabilities** are mandatory to be provided by the enabling technology Consortium partners; both on power device technology (ST-I) and on passive components one (WÜRTH and LUH): those partners will drive the project ambition in the relevant essential capabilities field.

Regarding Essential Capabilities target here below a resuming Table:

Table 3: Summary of Ambition in Essential Capabilities MASP

	State-of-the-art	Breakthrough	Impact on MASP
Innovation on power device technology FE/BE	1200V SiC planar MOSFET available in the market	1200V – 1700V SiC trench MOSFET with very low on resistance and improved dynamic performances	MASP 11 Process Technologies
Passive components technologies: Tailored Magnetics and capacitors for SiC Application	No standard magnetics and capacitors for SiC Applications	New materials tailored for SiC	MASP 11 Process Technologies
Open platform: reference designs for cross-segment applications, a first step to boost Disruptive Innovation in Power Domain	Ecosystem is still under Development	Reference Designs across different segments allow faster customization and industrialization.	MASP 12 Design Technologies
Reliability and Design Methodologies: Co-development Of design methodology across the application valuechain: from application to SiC IC's	As of today, Co-development methodologies are already used, although not standardized, in other technology platforms. SiC requires different parameters to be taken into account and tailored models of behaviour for the key components of an application. In particular reliability is a key topic for SiC exploitation.	Having defined a standard flow tailored for Silicon Carbide allow improvement of the design cycle and simulation can guarantee a faster understanding of optimization loops and a common outlook for the stakeholders.	MASP 12 Design: Technologies
	Key reliability issues		MASP 12 Design:

<p>Reliability and Design Methodologies</p> <p>Chip Robustness</p>	<p>have not been fully resolved and not direct link between failures and SiC structure:</p> <ul style="list-style-type: none"> - avalanche mode; - stability of the device threshold voltage, VT - the reliability of the gate oxide 	<ul style="list-style-type: none"> - Design of peripheral protections associated to the target of robustness in avalanche mode; - OBIC experimental verification of the efficiency of the peripheral protections; -Electroluminescence to experimentally verify the efficiency of on-state design - Definition of measurements procedures to avoid underestimation in Vth shift 	<p>Technologies</p>
---	---	--	---------------------

1.4.2.1 ST-I Ambition in power device technology FE/BE

Semiconductor device makers involved in SiC activity have been mainly focused to diode production which right now are well accepted components and widely used devices in many applications from industrial to solar to automotive, SiC MOSFET are starting to be commercialized with some volumes and challenges to win in order to reach mass market are in two branches: performances and quality.

Due to the high cost of the raw material, forcing to high cost of single component, very high end performances but also very high quality are requested.

The ambition of the project is to let ST-I target the best performances ever obtained in high voltage power devices with improved quality level.

To obtain such result an innovative trench structure will be developed and adopted to 650V and 1.2kV MOSFETs. Fabricated devices will be assembled in innovative packages able to emphasize device thermal behaviour even with very high current densities. Moreover, the highest standard of quality will be applied in order to guarantee best quality performances in end user hands.

Trench MOSFET structure will allow to target Figure of Merit On Resistance*Area as low as 3 mΩcm² at a off state voltage 1.2 kV while today, in commercially available SiC planar MOSFET, it's close to 10 mΩcm². A big improvement is also targeted for Dynamic performances with a Qg*Area as low as 20 nCcm², starting from 120 nCcm² value measured on commercially available SiC planar MOSFET. This is mainly due to strong increase of channel mobility and JFET resistance component reset.

1.4.2.2 WÜRTH and LUH Ambition in hybrid integration and passive components technologies

Innovation in process technologies is particularly needed in Passive components like Capacitors and Magnetics.

A significant breakthrough is needed to integrate switches and passive components (magnetics and capacitive) more closely: in order to reduce stray inductances and skin effect due to high output currents and high frequency switching requires significant effort for to redesign interconnections and dies integration. Breakthrough is needed to integrate more closely to the switches passive components (magnetics and capacitive). Reduce stray inductances and skin effect due to high output currents and high frequency switching require innovation in PCB and dies integration.

The integration of active and passive components into the FR4 based PCB laminates is a trend in smart system integration. According to project specific targets the new technology components required in order to reduce package size (miniaturization), increase of switching frequency for better energy efficiencies improving the affordability of SiC applications (strengthening the EU industry). Finally the developed components should be used as the standard components for SiC applications.

The target of WInSiC4AP is to evaluate the adaption of novel magnetic and capacitive technologies for application fulfilling the isolation and insulation barrier requirements. This involves the development of new materials and the optimization of existing and/or introduction of new manufacturing processes.

Those activities will be performed via:

- developing of the new passive components for SiC applications;
- developing of the new technologies and processes for manufacturing ultrathin foil-like electronic devices with respect to the application within SiC based components.
- adapting a novel low profile MtM technology based on magnetics-on-silicon for applications with high insulation barrier requirements, defining the suitable materials and manufacturing processes;
- building the application specific component prototypes (gate drive transformer) and evaluation of their performance and reliability as a part of the integrated demonstrators.

State-of-the-art wire wounded gate drive transformers are bulky components which are not suitable to allow system-in-package approach. Typically used EP5 standard package has dimensions of 8,5x7x6mm.



To fully utilize the size reduction of SiC transistors compared to MOS transistors, also auxiliary devices like gate drive transformers need to be shrunk. Ideally the gate drive transformer should be capable of being integrated together with active gate drive components in one package. Studies have been made based on copper sheets realized on FR4 laminates to build smaller transformers. However this approach shows performance limitations since it doesn't allow the manufacturing of closed soft magnetic cores.

Miniaturization and increasing of power density were studied by some researchers. A good example of fabrication coreless planar transformer by using common PCB technologies is shown in [TAN01]. There is another aim – to build a transformer smaller and cheaper than traditionally coiled. In order to reduce the package size the innovative components are required. The fabrication strategy is different. In the above mentioned work a 0.4 mm thick double-sided PCB laminate with a copper sheet thickness of 35 μm were used. The area of the whole device is of 0.6648 cm^2 . This fabrication strategy has no capability to manufacture a closed magnetic core transformer as soon as no PCB board includes any soft magnetic materials at the moment. So this transformer is suited for a specific frequency range in consideration to the efficiency.

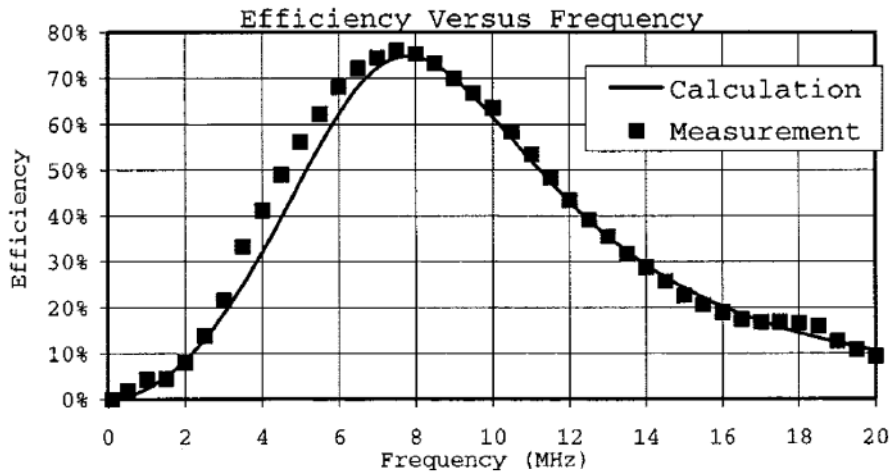

Figure 22: Efficiency vs frequency

To provide a wider high efficiency range the fabrication of magnetic core based planar transformer is defined as breakthrough [CHE03]. In the work an eight-layer PCB is manufactured with integrated planar coil windings. The copper thickness of each layer is 0.14 mm and the insulation barrier is 0.15 mm. The windings are enclosed in an E-I magnetic core. Three different building strategies are presented. All of them are not well suited for high frequency applications.

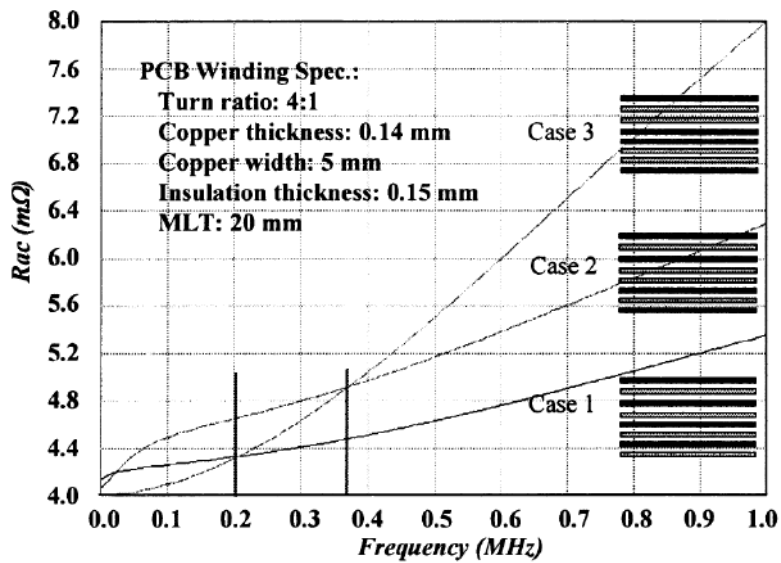

Figure 23

WÜRTH and LUH are working since 2013 on an innovative batch manufacturing process of micro-transformers. The footprint area of such micro-transformers is compatible to Electronic Industry Agency standard size 1008.

[TAN01] Tang, S. C.Hui, S. Y. Chung, Henry Shu Hung; A low-profile low-power converter with coreless PCB isolation transformer; IEEE Trans. on Power Electronics, 16 (3) p. 311- 316, 2001

[CHE03] Chen, Wei, Yan, Yipeng, Hu, Yuequan, Lu, Qing; Model and Design of PCB Parallel Winding for Planar Transformer; 39 (5 II) p. 3202-3204, 2003

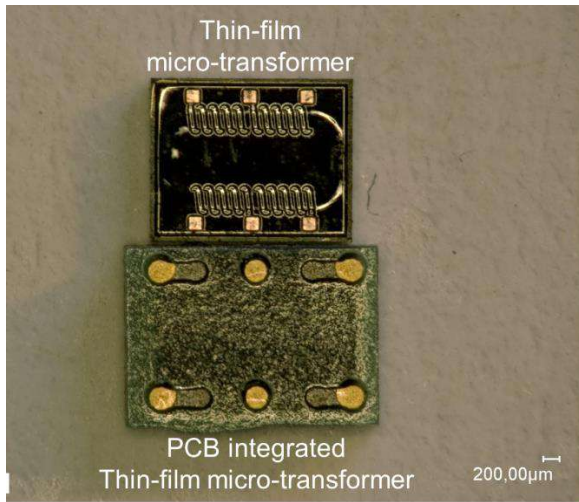

Figure 24

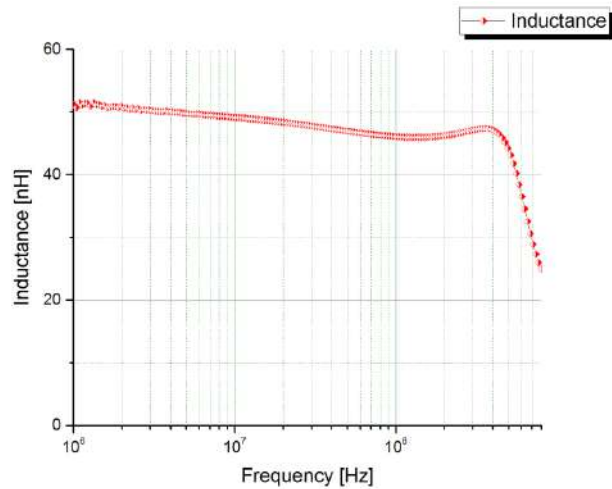

Figure 25

Nevertheless the performance of the transformers is limited by thin-film technology and in its current state is now an optimal solution to be integrated into SiC Gate Drive Transformer solutions.

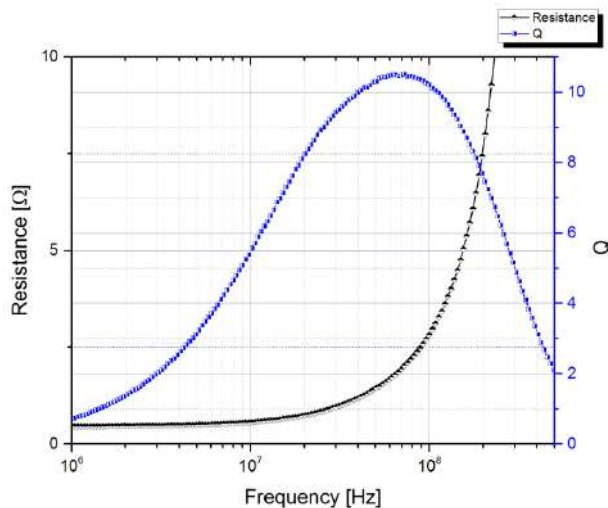

Figure 26

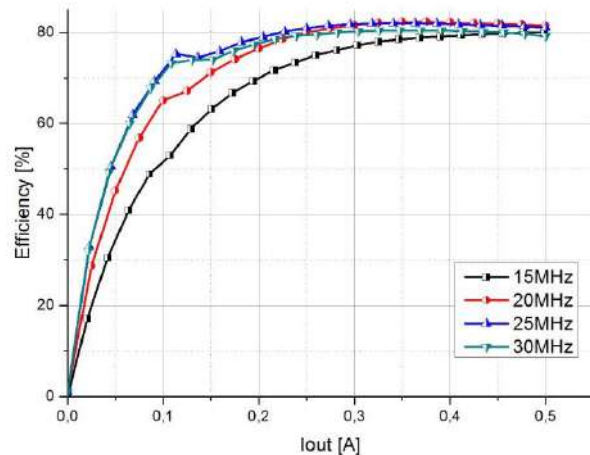

Figure 27

To maintain the smallest possible package and fulfilling the requirements of power electronics the high performance materials are needed. The properties of the magnetic parts of the components are confined within those which can be deposited with thin-film technology. Another restriction is driven by high breakthrough voltage requirement for power electronics. The use of thick polyimide foils looks promising. Similarly it can be used via preconditioned magnetic laminates. The innovative fabrication strategy outperforms the capabilities of generic thin film technology. The usage of preconditioned foils is well known in the PCB fabrication.

During WInSiC4AP project WÜRTH and LUH will be in charge of the component definition, design, evaluation and characterization whereas LUH will focus on material and process development and implementation.

1.4.2.3 ST-I Ambition in design methodologies

Open platform: reference designs for cross-segment applications, a first step to boost disruptive innovation in Power Domain (ST-I)

In this historical framework, disruptive innovations are changing the life and the economic model of markets as well as in the case of digital economy.

We witness each day digital platforms that are accessible worldwide and support economy of sharing (e.g. AirBnB, Uber). Assets required in that case have a low cost access and creativity can be exploited as much as possible.

Also in other domains like healthcare, we are going to assist to revolutions: remote monitoring or dispensing thanks to low cost of access to technologies.

In 2014 Google has launched for the first time a global competition to design and build a kW- scale inverter with the highest power density (at least 50 Watts per cubic inch, for reference visit the web site of the initiative: <https://www.littleboxchallenge.com/>).

Google has in fact research activities in the Power Conversion domain as it designs its Data Centers targeting relentless efficiency.

WInSiC4AP foster to develop opportunities to access advanced technologies like Silicon Carbide to boost disruptive innovation in Power Domain.

WInSiC4AP's ambition is to develop power bricks based on SiC technologies across different domains (e.g. *Automotive vs. Avionics*).

Having identified the user specifications, appropriate topologies, passive components and working conditions, it will be possible to approach an "Open Base" platform providing references for other market to be eventually customized to fit the application or to work around for additional breakthroughs.

These results will be further exploited in a second step to produce an Open SiC platform to boost innovation in power domain by giving access to SiC to innovators like Start Up.

In this framework: *ST-I, IUNET, CNR, UNIME* will be the major players in the investigation of the degradation phenomena at SiO₂/SiC interfaces and MOSFET devices, both experimentally and by means of numerical simulations.

Moreover WInSiC4AP addresses advancement beyond state of art on regard MASP Smart System Integration.

1.4.3 Ambition in Smart System Integration

WInSiC4AP Consortium cannot avoid to underline that its project ambition will affect heavily *Smart System Integration* too (*MASP ECSEL-GB-2015.46 on chapter 14^l*). In this respect an important project breakthrough, at the end-user application level, is to develop *systems* in SiC with higher power density and efficiency than currently available solutions. WInSiC4AP will use, accordingly, available technology bricks and will focus on new technology bricks that allow a deeper scale integration of components in modules as below more detailed.

Power modules are currently manufactured in a 2-dimension (2D) array for power devices. This standard industrial 2D architecture for power packaging, however, has the following intrinsic limitations shown in Table 4.

From the aerospace end user point of view in particular, one of the main target of the sector is systematically fostering mass reduction at all level of the system (spacecraft, airplane, UAV). The availability of components able to guarantee better performances and/or functionality at harder environmental conditions (i.e. higher temperature) certainly offers the possibility to reduce the mass of the system. Thus, SiC-based electronics represent an important advancement beyond the state of the art technology for the future of aerospace systems.

Table 4: *Current limitations of two dimension array used in power module today*

<i>Parameter</i>	<i>2D limitations</i>	<i>System impact</i>
<i>Thermal efficiency</i>	<i>evacuation of the heat produced in operation only by one side of the component.</i>	<i>Put a lot of constraints on heat management solution design, size, weight and cost. Set a limit to maximum power density.</i>
<i>Electromagnetic Coupling</i>	<i>the 2D-arrangement of devices, interconnects and capacitive coupling generate electromagnetic radiations.</i>	<i>Specific filters required to comply with electrical standards increase the system cost</i>
<i>Reliability</i>	<i>Wire bond failure due to strong thermal expansion difference between materials (especially for large die).</i>	<i>Module lifetime in severe use cases.</i>
<i>Thermal uniformity</i>	<i>asymmetry of 2D architecture generates die to die thermal differences within a module.</i>	<i>Additional die to die thermal margin limits the module performances.</i>
<i>Manufacturability</i>	<i>Minimum of collective operations.</i>	<i>Cost</i>

The WInSiC4AP project foresees innovation in the development of advanced packaging options to overcome these limitations.

For the packaging technologies, WInSiC4AP will focus on introducing a breakthrough in the robustness of the full assembly solution at high temperature on one hand, and on clamping the temperature evolution in the Package on the other hand. The ultimate goal will be to break new records in reliability:

- more than 5 times the state of the art, and also in performance at high temperature;
- ability to work at 200 °C or above.

A new generation of Power Modules, in particular moulded or using a three dimensional approach, optimized for integrating SiC devices will be developed.



Figure 28: A new generation of Power Module (here 3D)

The package reliability and robustness enhancement will be made through the use in the Power Module of new or advanced materials, processes and designs.

Table 5: Summary of Ambition in Smart System Integration MASP to reach >5times the state of art in reliability at working conditions >200°C

Packaging Activities	state-of-the-art	Breakthrough	Impact on MASP
Reliability	See table 4	-more than 5 times the state of the art ,and also in performance at high temperature; -ability to work at 200°C or above.	14 Smart System Integration
Materials: a- innovative substrates , potting materials, gels b- new green molding compounds for Molded Module, with specialcompound structure	See table 4	-a high reliability level, functioning at temperature higher than 200°C. -low leakage currents is the critical parameter	
Advanced Processes: c- Ultrasonic process to weld pins directly in the substrate d- Innovative and lead free Die Attach dedicated to SiC to improve electrical Performances f- Advanced Interconnection /Bonding less: -Al/Cu or Heavy Cu bonding on Cu front metal for homogenousjoint Cu-Cu - Tailored and customized front side clip (by ES and MR)	See table 4	1-Low contact resistance, high current capability, thermally and electrically stable joints, long life time. 2-RDSON reduced by 20%; Avalanche and Short Circuit resistance increased by a factor 5; Thermal Performances Rth reduced by 30%, ; Quality & Reliability (Life time in Power Cycling multiplied by 10 times); Zero voids in the die attach joint. -4-5 times of TC improvement -drastically improve the reliability performances (~1 to 10 global life time) and increase the load carrying capability.	

<p>g-Innovative methodologies for copper deposition on the front side of the SiC wafers as copper printing or sintering may be envisaged.</p> <p>h-3D approach using PowerBumps</p>		<p>-enhance the electrical performances by reducing all parasitic elements linked to bonding and enable a use at higher frequencies</p>	
<p>Innovative Designs:</p> <p>i- Cooling of both sides of the Power Modules</p> <p>l-3D design</p>	<p>See table 4</p>	<p>-Improvement of thermal capability increase in efficiency of converters.</p>	
<p>Thermal Management at substrate level for highest miniaturization</p>	<p>See Table 4</p>	<p>-$R_{th} < 0.3K/W$, $E_c > 10MV/cm$</p>	<p>MASP 14 SmartSystem Integration</p>
<p>High reliability using smart substrate</p>	<p>See table 4</p>	<p>- increase the thermal dissipation with an equivalent E_c</p>	
<p>Advanced SiC Module for Avionics:</p> <p>-New substrate materials like AMB Si₃N₄, diamond, carbon will be investigated with particular focus on integrated substrate with built-in cooling fins and DBA: light materials like Al (as the weight of Al used in the baseplate/substrate is about 1/4 vs. Cu)</p> <p>-Grinding will be performed on SiC</p>	<p>Current solutions still in SI 110μ is current thickness</p>	<p>-reduce the global weight of Power Module of 25-30% with DBA integrated substrates (Al substrates without and with pin fins).</p> <p>-50μ thickness for R_{th} improvement</p>	
<p>Advanced SiC Module for Railway and Defence Application:</p> <p>-bondless solution</p>		<p>-Stray inductance reduction by 50%</p> <p>- more than 20% improvement of electrical performance in high frequency, as well as thermal performances by avoiding the necessity to use forced cooling</p>	<p>MASP 14 SmartSystem Integration</p>

1.4.3.1 Ambition in *Materials for SSI*

In terms of materials will be considered innovative substrates, potting materials, gels... able to support and guarantee, with a high reliability level, functioning at temperature higher than 200°C). New green molding compounds, epoxy and non-epoxy based, for Molded Module, with special compound structure for low leakage will be used. Adhesion and thermal properties of such molding compounds formulated with organic phosphorus based flame retardant and polyaromatic organic matrices will be studied through a well consolidated laboratory procedure. Molding compound for Hi temperature will be also used for special TO247 power discrete with SiC able to guarantee till 250 °C, will be used in the WInSiC4AP project for SiC prototype characterization (thermal, electrical, reliability, robustness in the application).

1.4.3.2 Ambition in *Advanced Processes for SSI*

SiC trench MOSFET development will drive, in Front End, many advanced process activity and many steps of the process flow are innovative:

- trench formation process in hard material like SiC has to be developed by identifying the right equipment and the right process;
- trench filling process has many aspects to be investigated and solved mainly because high voltage application requires thick oxide in the bottom of the trench in order to minimize electrical field crowding at the bottom of the trench;
- trench surface recovery has to be optimized in order to maximize channel mobility and reduce final device On resistance;
- moreover in order to allow high current density flowing through SiC MOSFET new material and process has to be adopt for front and backside metallization in order to exploit entirely SiC benefits and don't limit device current capability with package limits.

Advanced Processes will be developed or improved for advanced Power Module fabrication.

Ultrasonic process to weld pins directly in the substrate with high quality ensuring low contact resistance, high current capability, thermally and electrically stable joints, long life time; **Innovative and lead free Die Attach** dedicated to SiC to improve Electrical performance (RDSon reduced up to 20%, Avalanche and Short Circuit resistance increased by a factor of 5), Thermal Performances Rth reduced by 30%), Quality & Reliability (Life time in Power Cycling multiplied by 10 times). Zero voids in the die attach joint shall be targeted.

This will also imply to improve the Front End and Back End fusion, meaning co- designing since the early beginning of both the SiC technology and the Assembly processes, in order to get an optimal result at the finished product level. This requires to identify and implement a customized and dedicated metallization for the front and back sides of the SiC wafers: composition, thickness, grain size, morphology, stack sequences... to produce the optimal die attach joint. Advanced Interconnection / Wirebond less options to reduce the interconnection resistance and increase the current capability as well as to improve the Reliability level. The project is intending to overcome Al interconnection limitations by the use of: Al/Cu (~4-5 times of TC improvement) or Heavy Cu bonding on Cu front metal focusing on tailored and customized frontside clip-like structures, made of raw or plated (Ag; Au; Pd;...) copper, to achieve an effective thermomanagement system and "state of the art" electrical performances improving drastically the reliability performances and the load carrying capability.

Innovative methodologies for copper deposition on the front side of the SiC wafers as copper printing or sintering may be envisaged. Ultimately a 3D approach using power bumps will be used after adaptation to SiC (Figure 29). This will enhance the electrical performances by reducing all parasitic elements linked to bonding and will enable a use at higher frequencies.

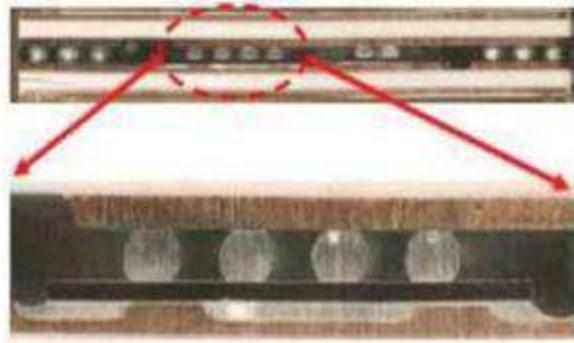

Figure 29: 3D approach using Power Bumps

1.4.3.3 Ambition in *Innovative Designs for SSI*

SiC trench MOSFET development will be based on innovative integration scheme allowing to obtain high voltage devices and able to limit the high electric field on the bottom and on the corner of the trench. The elementary structure of the device will be strongly reduced respect to current planar technology in production in order to maximize the MOSFET channel perimeter and reduce the device on resistance. Moreover an innovative edge structure will be also used allowing to minimize electric field crowding on the edge of the device and reaching a high and stable breakdown at high voltage.

Cooling of both sides of the Power Modules is greatly improving their thermal capability (Figure 30). Thus an increase in efficiency of converters of several percent may be achieved. Innovative designs, based on **3D techniques** as well as some of the above advanced materials and processes, will be studied in order to get the best of the SiC technology.

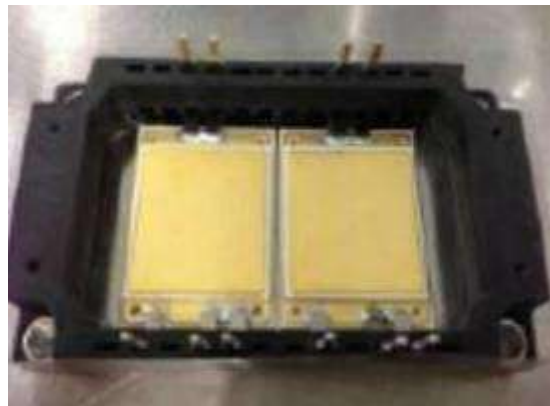

Figure 30: Power module: Dual side cooling

1.4.3.4 Ambition in Thermal Management at substrate level for highest miniaturization in SSI

An heterogeneous substrate using advanced materials (core package material and passivation), Carbon based with high thermal conductivity and insulator materials, will be developed with the aim to reach the highest critical field with low R_{th} and with an integrated heat sink on the backside of the component. This solution will consider its manufacturing potentiality and a reduced cost.

1.4.3.5 Ambition in Advanced SiC Module for Avionics in SSI

A specific advanced SiC Module will be developed by ST to answer to the needs of Avionics: New substrate materials like AMB Si₃N₄ silicon nitride (Si₃N₄), diamond, carbon will be investigated with particular focus on integrated substrate with built-in cooling fins and DBA: light materials like Al will be introduced rather than current bulky ones to reduce the global weight of power module of 25-30 % (as the weight of Al used in the baseplate/substrate is about ¼ vs. Cu) with DBA integrated substrates (Al substrates without and with pin fins).

AMB: Active Metal Brazing.



Figure 32 Inverter module prototype – target is to reduce the global weight of 25-30%

Reliability will also be improved by developing the relevant Known Good Dice (KGD) test coverage at current as high as 200 A, including testing the avalanche, binning for better matching of dice and so reduced consumption and longer life time. This KGD will be performed on SiC dice possibly reduced by grinding to 50µm for Rth improvement, while today’s state of the art is 110 µm. Such dice will also be characterized mechanically; three points bending, brittle test.



Figure 33 Grinding to move from current state of art of 110 µm thickness up to 50 µ reducing Rth

1.4.3.6 Ambition in Advanced SiC Module for Tramway and Defence Application in SSI

An advanced 3D Power Module with Dual Side Cooling (double side approach) will be used, with a wire-bondless solution to drastically reduce the parasitic contributions (stray inductance reduction by 50%), improve electrical performances such as overvoltage or losses under high current switching, as well as thermal performances (more than 50 % heat extracted for a given junction temperature), improving compactness, cost, weight and reducing the need for an oversizing of die voltage rating.

aPSI^{3D} will develop a 3D power packaging modular solution, fully optimized for SiC, which will enable functioning at high Temperature (200°C), in both parallel and serial stacking to encompass both high current

(1KA surge) and high voltage (1700V) requirements. Such a solution is highly compact and light.

The process integration to optimize the solution for SiC should require a finer characterization to adapt the key processes and materials (e.g. die attach, interconnection attach, substrate warpage control and compensation, thermomechanical constraints) to SiC specifics, Material resilience to temperature must be assessed and reliable safe operating domains must be defined. Eventually, the whole mechatronic design process should encompass the necessary compatibility with higher temperature and higher voltages.

It could be needed to insert, in the tiny volume dedicated to electronics, drivers and some thin passive elements. Indeed, those should be as close as possible to transistors. This should reduce the loop inductance and make possible higher current and higher frequency switching.

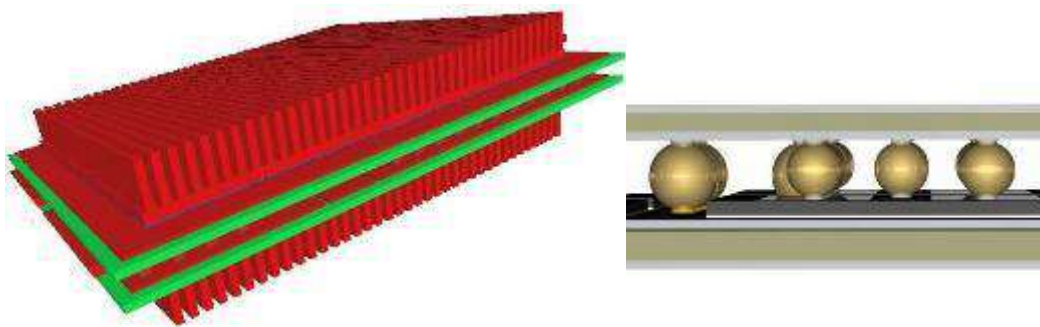

Figure 34 Dual side cooling 3D Power Module

Bleedless cooling will be investigated; liquid cooling is considered as constraining, in terms of maintenance because of leaks. Its elimination would be a definite gain. Understanding how SiC can really be exploited for minimal heat dissipation and revamping the intimate intertwining of cooling and electronics in a mechatronics perspective is a real challenge. Advanced heat sink materials and substrates as for Avionic Module shall be considered for prototyping.

Parasitic elements of this 3D Power Module will be extracted for modelling and simulation use in application conditions.

2. Impact

2.1 Expected impacts

Introduction

The WInSiC4AP project will focus on the technology transfer from the process level to the application level of the SiC components, by applying a radically new approach. Most of the past programs on the SiC in Europe, have been driven by the Semiconductor players, to enhance and improve the process and to get rid of the major obstacles on the production of the largest possible portfolio of devices. Now that the major building blocks are available, the approach for a full and successful deployment of SiC in mass-production applications must be different. On the other side, “Electro-mobility”, which is widely foreseen as the killer application of SiC, has seen a quantum leap in the last two years with some important success stories (Tesla’s S/X models, Nissan’s Leaf). It is now time for a new revolution in that battery cells are expected to be available in the short time in large quantities (2017-2020)⁴ while high voltage packs are expected to become robust and affordable in the same timeframe. The first generation of electric vehicles had the maximum voltage of less than 250V, because of technological problems in the assembling of long arrays of cells reliable enough (each cell rated at about 3.6-4.2 V). Now that Tesla, for the first time has brought into the market a solution with a battery pack voltage of above 350-400V, the ideal conditions for the deployment of SiC power system is mature. In the mid term DC-link will further increase and the current limit of 400V will realistically become 600-850V in the next two years. However even at the current state-of-the-art, the use of a SiC-based converter is already affordable and feasible, in that the energy efficiency figures (>99 %) and the power density (higher than a Si die) reached in the recent time, are really impressive.

Therefore the interest of European OEMs and TIER1 is rapidly increasing, also becoming a matter of competitiveness against US and Japanese producers. It is now time that Si Providers start to tailor and adapt their components and modules to the necessity (thermal management, EMI issues, parasitic effects) of the specific applicators and to the needs of the system integrators (TIER1 and TIER2).

DTSMNS, supported by ST Project Technical Manager (PTM), has taken up the challenge by leading the WInSiC4AP project with the major aim to meet the application developers and bring them inside the process development. This approach will allow application developers and end users to better understand the technological issues and raise the awareness on the potentiality of the technology, and for the Semiconductor provider to design and manufacture modules made on purpose of the application and therefore gain a more aggressive portfolio of products.

Moreover the clustering of the application between the Automotive, the Energy, the Railway and the Avionic sector is the key to reach the desired critical mass for a fast, cost effective and successful deployment of SiC power switches.

The impact of this approach is essential for the survival and the competitiveness of the European Power electronic industry which, already challenged and threatened by Japanese and US car-makers, TIER1/2 and silicon providers, can easily be overcome also by Chinese which are starting to propose aggressive solutions on power systems and semiconductors.

The expected impact of WInSiC4AP project is to contribute to developing marketable-cost effective products and relevant technology bricks to boost key applications like Electric Vehicles and technology adoption in other key applications like railway, avionics and defence.

Moreover, impact is foreseen in analysis of the conditions, business models included, for building an open platform to favour new ideas and promote innovation in the power domain, keeping Europe on the cutting edge.

DTSMNS has got relevant competencies in managing large scale projects at national level along value-chain

⁴ http://www.teslamotors.com/it_IT/gigafactory visited the 4th of September 2015

in the fields of Smart Energy, Smart Health and IoT, with relevant results as project outcomes in term of IP, technology bricks prototypes and applications.



Figure 35: WInSiC4AP Excellence impact on different aspects of European Leadership

Societal Challenges

The mobility sector faces several burning societal challenges:

- reduce carbon dioxide from transportation
- improve of air quality.

In these areas, Europe must pursue two parallel objectives: serving society's needs and maintaining global leadership with the very ambitious goal of cutting 60 % in transport emissions by the middle of the century (2050).

This objective has to be reached through different means:

- elimination of conventionally-fueled cars in cities.
- 40 % use of sustainable, low-carbon fuels in aviation; at least 40 % cut in shipping emissions.
- a 50 % shift of medium distance intercity passenger and freight journeys from road to rail and waterborne transport.

These challenge objectives requires the significant breakthrough targeted and enabled by the WInSiC4AP Project demonstrators with paradigm changes standard, regulations, policies and infrastructures for mobility.

European competitiveness

Enabling these challenging objectives requires innovative technologies (e.g. inverter in SiC, DC/DC) and products (e.g. affordable generation of HEV-EV) with fundamental changes in standardization, regulation, policies and infrastructures for mobility in a broad multimodal sense, from road and energy.

Looking at automotive market, hybrid and electric vehicle market is growing and analysts see a dramatic acceleration in 2020. To sustain this roadmap WInSiC4AP proposes products with clear competitive advantages (cost, packaging volume, efficiency) to approach a very intense competition and a lot of new players from industry trying to enter in their non- conventional market.

Threats are to not be ready or sufficiently competitive for 2020 market, and then will not be any more in the race for this kind of products later on.

Main competitors are conventional players, but the fear comes from new players like Delta company, well implanted in industrial conversion since years and thanks to their high volume purchasing in power components and localization in China, able to propose very competitive price. Other types of competitors are Japanese suppliers of components that are entering the market with full product proposal (Nichicon, Panasonic, Hitachi).

Particularly Japanese OEM Car Maker and TIER1 (Toyota/Denso and their suppliers) are using this converter since years, they are aware of the potential of SiC for HV converters. This explains why they launched 5 years ago important research and innovative actions to promote development of technologies: components, magnetics and complete products. They claimed in 2014 having developed prototypes of inverters and DC/DC converters based on SiC technology able to reduce losses of 40 % and reducing the size of product by five. They are now in process to test this technology and planned to use it in mass production in 2022.

It is then fundamental for European OEM to catch up this technology in order to be able to compete on the market with high voltage and low voltage solutions, including DC/DC HV to HV converters at good price, for affordable vehicles, trains, aircrafts by providing improved autonomy (within higher efficiency of its components).

WInSiC4AP specific economic impact

Europe plays a leading role in automotive and other transportation sectors, so it is fundamental that key enabling technologies and product manufacturing are maintained in Europe to maintain strategic

independence and competitiveness. WInSiC4AP foreseen a sustainable economy in line with European GDP growth:

- address a potential market of >3.5 B\$ (TIER1-TIER2 only) and an impact of more than 0.7 B\$ business after 5years of project closure in 2023;
- project >=5 % job increase along the value chain.

SiC-based EV/HEV inverter bill-of-material evolution from 2012 to 2020 along with devices and components price erosion

(Source : SiC Modules, Devices and Substrates for Power Electronics Market, Yole Développement, October 2014)

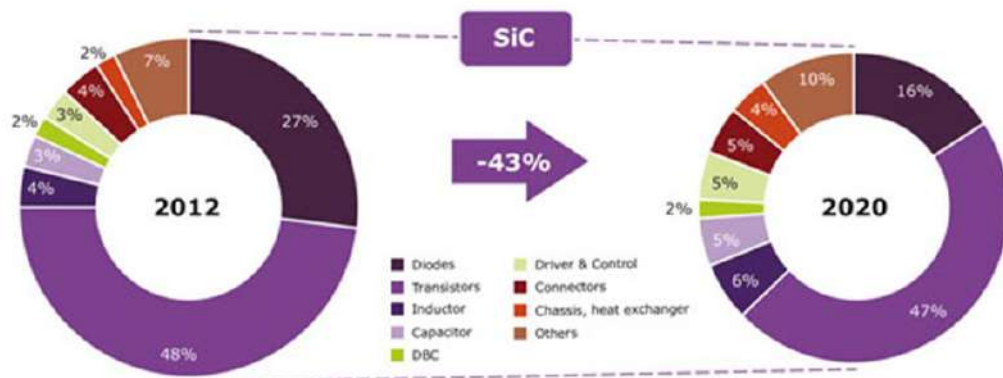

Figure 36: SiC- based inverter bill of material evolution from 2012 to 2020 with devices and components price erosion – source “SiC Modules, Devices and Substrates for Power Electronics Market”, Yole Développement, October 2014

Expected Impact on Essential Capabilities: guaranteeing access to advanced technology breakthrough for European Competitiveness

WInSiC4AP contributes to develop breakthrough technology bricks and design methodology that enables higher performances, high temperatures and high reliability enabling cost and efficiency effective key applications.

The definition of a tailored design methodology with tuned simulation and behavioural models for SiC can dramatically change the speed of SiC adoption, thereby benefiting the competitiveness of European ecosystem and increase power conversion efficiency.

Competition is fear also in essential capabilities and it is limiting the access to the SiC technology with high contractual barriers and by integrating the solution (as stated for key application it is the case of Japanese industries Nichicon, Panasonic, Hitachi).

WInSiC4AP will foster the following impact for the competitiveness of the EU ecosystem:

- Keep independent access to IP within the European Ecosystem: the WInSiC4AP project will allow the partners involved to develop their own patents on particular solutions conceived inside the project, supported by the advantage of an integrated supply chain from basic components to the end-user applications. The following opportunities are foreseen
 - Test Bench: The unique cell in the architecture of the rack are possible patenting opportunities, which will be reviewed during the project. The corresponding work has been taken into account in the project cost
 - High reliable module adopting advanced processes (substrate, Wafer scale packaging, etc...)
 - New technologies and materials for passive components

- Exploit SiC adoption by increasing design methodology and fast development cycle: academia and large research institutions involved in the project will develop design methodologies that will allow increased awareness and fast deployment of SiC technologies inside the EU ecosystem. In particular this approach is expected to be extended in other application domains like industrial motor drivers
- Like other European Funded Projects, WInSiC4AP has been conceived as an “open innovation” project to pursue the collaboration of industry and academia:
 - The development of demonstrators or the package technology, the interactions among the partners and the approach of a common methodology will generate integrated knowledge, strengthening the competencies and therefore the competitiveness of the ecosystem as-a-whole
 - In this project, companies working in different domains (automotive OEMs and suppliers, avionics and railway TIER1-TIER2) and in the vertical value chain (semiconductor and passive components suppliers) as well as academia and large research institutions will collaborate to co-design solutions, solve problems and exchange know-how, such that unforeseen results may also emerge from cross-domain interactions
 - WInSiC4AP, by involving in the partnerships regional clusters and ESIF participants, has the ambition to contribute to the growth on new enterprises that could disrupt the current paradigms in Power Conversion domain where strong expertise and access to high value assets are needed. The Open Platform of reference design and the specific dissemination and exploitation activities will support the access to the technology for new Start Ups in the Power Domain and in the electro-mobility sectors.

Figure 37 below shows how co-designing a solution with a specific compactness target implies the exchange and integration of know-how and working within a collaborative framework that also enables discovery of unforeseen results.

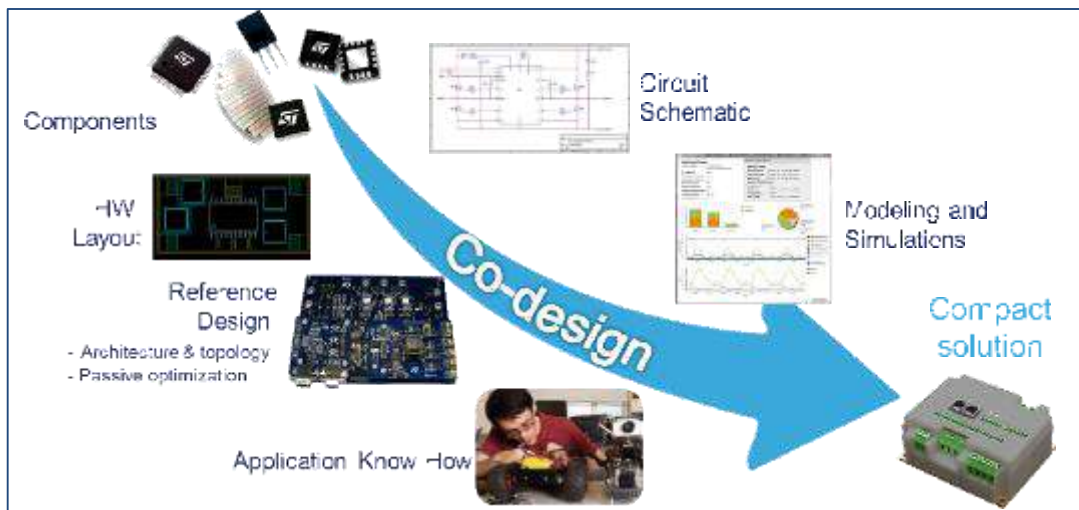

Figure 37 The Co-design of solution implies an exchange and integration of knowledge across the design chain involving different partners

WInSiC4AP will be supported with synergy between ECSEL JU and ESIF funding enabling complementary activities with relevant economic and social impact envisage in a less development region of Union. It will contribute to build the synergy between the RIS3 policies and the objectives of ECSEL JU, combining funding from different sources. The exploitation plan for innovative devices and systems will require further investment in skills (job creation) and capex to support engineering and manufacturing exploitation also located in European less developed regions (e.g. ESIF Regions in this project).

Table 6 Summary of WInSiC4AP challenges - expected impact on MASP Key applications and Essential Capabilities (*business impact is an estimation based on projected Market)

Challenge	Impact
<p>Societal Challenges</p> <p>Elimination of conventionally-fuelled cars in cities.</p> <p>-40% use of sustainable, low-carbon fuels in aviation;</p> <p>-at least 40% cut in shipping emissions.</p> <p>-50% shift of medium distance intercity passenger and freight journeys from road to rail</p>	<p>Innovative Cost Products</p> <p>High Efficiency – reliable cost effective innovative converters for Automotive, Railway, Avionics and Defence:</p> <ul style="list-style-type: none"> - to sustain 2050 adoption of low CO₂ mobility - to reach >95% power efficiency converters in the addressed domain - to reach 40% size / cost reduction
<p>European Competitiveness</p>	<p>Opposing competition and keep European leadership</p> <ul style="list-style-type: none"> - Opposing competition and Independent access to Advanced technology bricks : Japanese companies, full product provider (Nichicon, Panasonic, Hitachi), American ECS companies limiting access to their IPs, non-traditional competitors (Chinese integrators like DELTA) --Strength European exchange and integration of knowledge driven by vertical integration - building an open platform to favour new ideas and promote innovation in the power domain
<p>Economic Impact</p> <p>-Target Market of European industries* (computed on TIER1-TIER2 after 5years of project closure)</p> <p>-- Job creation</p> <p>-Promote Start Up in power domain</p>	<p>Sustainable economy in line with European GDP growth target</p> <ul style="list-style-type: none"> - Addressed Market 2023 >3.5B\$ - Expected Business 2023 >>0.7B\$ - new jobs 2023: >5% in the addressed Consortium. ESIF funding will ensure the involvement of partners located in EU underdeveloped region where it will be possible to increase distinctive competencies and create qualified job -new enterprises along the value chain and business opportunities for less developed regions - #1 Contest

- *As regards any barriers/obstacles, and any framework conditions (such as regulation and standards), that may determine whether and to what extent the expected impacts will be achieved. (This not include any risk factors concerning implementation, as covered in section 3.2.)*

Regulation and standards may condition the achievement of long-term impact objectives. In the case of EVs, for example:

- The HEV-EV market is still not mature for a significant substitution of fuel-propelled car because new vehicles have higher costs and reduced autonomy. However, as for the successful example of Norway⁵ (Figure 38), regulation, standards and incentives can help to boost the market creating the condition for the end-user wide acceptance.

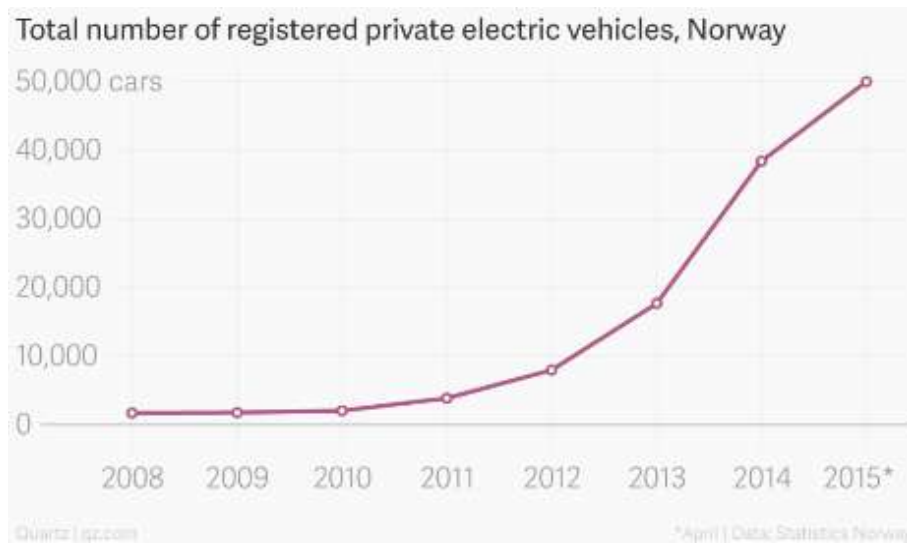

Figure 38: Evolution of number of private electric vehicle Norway

- Strong effort is to be dedicated to the deployment charging infrastructure, with little or no impact on the public finances where sometimes only the reduction or the cancellation of the VAT is sufficient to mobilize huge private investments, for the deployment of:
 - a. Fast charging stations, along the major communications lines in Europe and in the urban centers (Tesla, installing its own private charging stations in US, Europe and Far east is one of the examples)
 - b. Solutions for reliable daily slow-recharging at home, with incentives for the set-up of dedicated connections inside the private urban conglomerates (buildings)
 - c. Tax incentives for the set-up of charging station inside commercial centers and workplaces.
- Moreover the right strategy and mix of regulation, standards and incentives for Energy Efficiency are welcome in that they will first act on the top of household appliances for electrical power local generation, distribution and conversion: as an example the reduction of incentives for the selling of the energy produced by household PV panels started 2013-2014, is surprisingly acting in a positive way by pushing people to acquire battery packs for the re-use of its own energy (Again Tesla is at the forefront of this new business). This in turn is positively impacting on the price and the technology of the battery systems for automotive and appliances.

⁵ <http://qz.com/400277/norway-electric-car-incentives-were-so-good-they-had-to-be-stopped/> visited the 5th of September 2015

2.2 Measures to maximise impact

a) Dissemination and exploitation of results

Dissemination and exploitation of the project results are naturally the ultimate goal of the Consortium as a whole, as well as of the Partners individually. The technical solutions addressed by the project cover several markets that exhibit a constant growth, and whose cumulated share is quite relevant. In such a scenario, it is evident how the supply chain put in place by the consortium will constitute a breakthrough innovation for all involved industries, thus providing clear competitive advantages. In this sense, the project will contribute to the consolidation and extension of the market shares of the industrial Partners in the business sectors of concern.

Dissemination.

The WInSiC4AP Consortium has planned an intensive dissemination activity to be carried out through scientific publications in peer reviews, electronic information, publications in popular reviews and participation in European events or Trade Fairs. A dedicated web site will be set-up presenting non confidential results accessible to the public.

On the following Table a summary of planned dissemination activities.

Table 7 Dissemination activities

PARTNER	Participation to Trade fairs	Participation to Conferences	Publications on Journals	Organization or participation to Workshops (specify)	EU events
DTSMNS		2	6	2	1
ST-I	2			2 Organization	3
UNICT	1	3	2	2 Participation	1
NEXTER	3			2 Participation	2
VSCM	3	3	0	2 APE France, APE Japan (participation)	2
IUNET	1	8	9	2 Participation	0
UNIME		3	6	2 Participation	2
UNIPRA	0	6	3	2 Participation WOCSDICE/EXMATEC	1
LUH	1	3	2		
CNR		3	9	WOCSDICE/EXMATEC <i>Participation/Co-organization</i>	
ZODAERO		1			1
APOJEE	2	1 PCIM Europe			2

		Automotive Testing Expo Europe			
aPSI ^{3D}	1	2			
WÜRTH	2	3	1	1 Magnetics Session at PWRSOC Conference	2
UNITOU		5	5	1 WOCSDICE / EXMATEC Participation/Co-organization	2
IMA	1	1	0	1 IMA annual workshop for important business partners.	2
ED				1 Utilities business conferences and industrial association meetings (Euroelectric)	
SOFT				1	
DAC	2	3	2	2	1

Below the preliminary list of conferences, journals and workshops/event that will be further examined in the WP7a and WP7b.

-Conferences:

- IEEE International Electron Device Meeting (IEDM)
- IEEE International Reliability Physics Symposium (IRPS)
- International Conference on Silicon Carbide and Related Materials (ICSCRM)
- European conference on Silicon Carbide and Related Materials (ECSCRM)
- International Conference on Diamond and Carbon Materials
- European Symposium on Reliability of Electron Devices, Failure Physics and Analysis (ESREF)
- European Solid-State Device Conference (ESSDERC)
- IEEE Energy Conversion Congress and Exposition (ECCE)
- ICT2017
- TRA2018
- Yearly European Nanoelectronic Forum
- Congress of International Council of Aeronautical Science (ICAS)
- International congress of Italian Association of Aeronautics and Astronautics (AIDAA)
- International congress of Council of European Aerospace Societies (CEAS)
- Integrated Power Conversion and Power Management (PWRSOC)
- Applied Power Electronics Conference (APEC)
- Automotive power electronics (APE Europe and Japan)
- ECPE technical conferences

-Journals:

- IEEE Transactions on Electron Devices
- IEEE Electron Device Letters
- IEE Electronics Letters
- Solid State Electronics
- Applied Physics Letters,
- Journal of Applied Physics
- IEEE Transactions on Device and Materials Reliability
- Microelectronics Reliability
- Microelectronic Engineering
- J. Cryst. Growth
- IEEE transactions on Power Electronics
- IEEE Transaction on Energy Conversion
- IEEE Transaction on Industry Applications
- Aerotecnica Missili e Spazio
- Aerospace Science and Technology
- Journal of Aeronautics & Aerospace Engineering

-Trade Fair:

- Electronica
- APEC
- PCIM Europe
- International Paris Air Show
- International Farnborough Air Show
- Mondial auto show (mondial de Paris, IAA Franckfurt)
- International Farnborough Air Show
- Semicon Europe
-

-Workshop and other events

- Targeted workshop at the site of the project coordinator of all the partners of the project, open to external interested parties
- ECS
- MRS
- E-MRS
- WOCDICE – EXMATEC
- AvioLab, International workshop on General and Business Aviation organised by DAC
- Magnetics Workshop at PWRSOC Conference

The dissemination activity is part of the Communication Strategies to be defined in WP7a and WP7b.

DTSMNS will provide the dissemination of the results inside the less developed regions of South Italy within the ESIF WP7b and in particular inside the SMEs enabling network at European and international level, working in synergism with WP7a.

Exploitations

A plan for the exploitation of the WInSiC4AP results emerging from the project will be generated across the project to monitor the potential developed by the project and support the protection and the exploitation of results in the shortest time.

Project-wide and individual exploitation and business plans will be prepared and continuously updated by the consortium and by each partner respectively, to exploit the result in the specific business cases.

Also Universities, Research Institutions and National/Regional Clusters involved recognise a beneficial effects by the participation in the WInSiC4AP first in the training and in the education activities: they are eager to consolidate their competencies on the fabrication and the implementation of SiC devices, module and application. These competencies will open each institutions initiatives involving project partners also fostering new collaborations with them. Specific PhDs fellowships will run at the various Universities in an international environment for training of high qualified experts in the field. Also from universities and research, IPs generation and contribution to Standards are foreseen.

As-a-whole the **Large Enterprises, the SMEs and the Research Centres** involved in the project foresee to **exploit project results into a generation of Extreme-High-Efficiency products. Together with the expected impact on IPs generation and job creation these are summarized in the tables 8 and 9 below.**

Table 8 Economic impact for TIER1-TIER2 of Automotive, Railway, Avionics foreseen after the project closure (2023)

MASP Topics Smart Mobility/Smart Energy	Demonstrators	REFERENCE MARKET	Final results exploitation and end-users enlargement
VSCM	<p>1 On Board charger for BEV or PHEV</p> <p>2 DC-DC Converters for HEV, BEV and FC</p>	<p>TAM for HEV converters is 443 M€ in 2025, Currently Denso is leading market position (approx. 5 major players + some new comers from industry business).</p>	<p>With WInSiC4AP project, VSCM aim is to take a position on the highly competitive market of HT-12V converters. Due to technical lag, without the expected innovations, VSCM will not be present on this product line. In case of positive results, a new product will be on the market following further activities and test in operational environment starting from 2020. WInSiC4AP project will then help a lot Valeo to recover a good competitiveness on DCDC converter and for On Board Charge to maintain market share and be the leader for new growing business of 7 kW chargers. These new products are a condition to maintain the development teams in Cergy Pontoise and the current production line of converters (no more competitive).</p>
NEXTER	<p>Intelligent Power Switches (IPS-RA and IPS-AA) for embedded Power Management in railway and avionics</p>	<p>10 years forecast is about 10000 modules / month</p>	<p>The NE current revenue is around 25 M€ / year. The improvement achieved with WInSiC4AP project will allow NE to gain new market shares in air-land area to achieve gradually 50 M€ in 2023. The expected job creation is 50 persons on 5 years sharing between NE and their subcontractors.</p>
ED	<p>High efficiency Bidirectional SiC-based Power Converter for V2G/V2H applications</p>	<p>Electric mobility and ancillary service provided to DSO and TSO</p>	<p>ED is already running some pilots in northern European countries with different products where regulation allows electric vehicles to provide ancillary service. Following further test activities in operational environment to be started in 2020 ED expects at least 500 CUs in the market.</p>

ZODAERO	Inverter for aerospace application	Future more electrical / all electrical aircraft platforms - including single aisle- in 2030-2035	The demonstrator developed up to TRL3-4 in the frame of WInSiC4AP project could lead to a power electronic product for future more electrical /all electrical aircraft platforms provided economical gains are demonstrated at aircraft platform level by the results of dedicated R&T project led by the aerospace industry
	1 LiPo Interface for Avionics 2 Engine Controller- Inverter for Avionics	Airborne Equipments, for General & Business Aviation, Commercial Aviation, UAV	The demonstrators developed in the frame of the present proposal could lead to a series of advanced high power density avionics products guaranteeing higher performances together with lower weight and lower need of operational temperature control, i.e. lower operational costs
DAC			

Concerning essential capabilities the whole Large Enterprises, SMEs and Research Center will improve in increasing market share, IPs and job protection and creation.

Table 9 Economic impact for Technology providers & Research Centers after the project closure (2023)

MASP Topics	Demonstrators	REFERENCE MARKET	Final results exploitation and end-users enlargement
ESSENTIAL CAPABILITIES:	Gate Transformers	Passive TAM corresponding around 0.12% of overall converter market *6-- Overall TAM in the range of 400Meuro	Extension of SiC technologies in power conversion will require more and more dedicated passive components. WInSiC4AP project will contribute to prepare the technologies for future production lines. CAGR will be in line with SiC electronics market adoption. -WÜRTH target is 5% Market Share of WW corresponding to 30M\$
	Capacitors & Inductance		

⁶ Total Market Value of converters approx. 3Meuro, of which 28% is the value of HW, of which 45% is the value of passive – Internal Estimation by EPCOS

<p>ESSENTIAL CAPABILITIES: SiC Test Bench</p>	<p>Industrial Test Bench for SiC applications</p>	<p>1000 products in next 10 years with 500k\$ x unit</p>	<p>APOJEE is target a Market share in 2013: >10%. <u>2 job creation planned for WInSiC4AP project</u>, 10 to come as soon as the nominal rhythm of 10 test benches per year is reached. Patenting opportunities for the architecture of the unique cell</p>
<p>ESSENTIAL CAPABILITIES: SiC devices and module</p>	<p>SiC Mosfet >1200V (1700V), lower Ron, SiC Diode 1200V SiC 650V (including Power Modules)</p>	<p>TAM 2020, 2021,2022, 2023 = 1B\$, 1.3B\$, 1.5B\$, 1.8B\$ (with Power Modules)</p>	<p>ST counts to materialize thanks to WInSiC4AP an enlargement of current customer bases and target to reach a significant market share in 2023 in the range of > 20%. In terms of jobs there will be a protection of actual employees working on R&D, FAB and additional specialized and qualified personnel will be employed in the next 5 years.</p>
<p>ESSENTIAL CAPABILITIES: processes for SiC packaging</p>			<p>WInSiC4AP project will allow new breakthrough in term of SiC thinning, high voltage and high current test on die, SiC reliability and Power Wafer Level Packaging</p>
<p>ESSENTIAL CAPABILITIES: aPSI3D</p>	<p>RADICAL INNOVATION in module: dual side cooling</p>		<p>aPSI^{3D} forecasts to capture 10 to 12% of the targeted SiC market in 2022, thanks to their innovated packaging solutions optimized for SiC. The company also expects to increase the headcount by more than 40 persons in the next 5 years.</p>

Knowledge Management

Setting up knowledge-management procedures.

The consortium will establish a set of rules for knowledge handling and procedures for knowledge-management as part of the Consortium agreement (identification and reporting of exploitable knowledge, major procedures e.g. consensus on publications, etc.).

Reusing of knowledge, technologies and demonstrators for applications not specified in the proposal, will be evaluated during the program and a specific report will be generated in M36 (WP7a and WP7b) in order to exploit the developed technology platforms and demonstrators in all potential markets by industrial partners along the whole value chain.

WP7a/b Leaders and Project Manager (PM) will set up a **working group that will coordinate the implementation of the knowledge management activities, his/her role encompassing as a first step the preparation of a common database of relevant scientific information**, and then the regular updated of the contents. This information can be shared on a common network data server.

Workpackage 7a/b (Knowledge management) will manage the generation, protection, distribution and exploitation of the knowledge arising from the activities of the project. The Work Package leader and the working group identified by the Project Manager will ensure that relevant knowledge generated is made available for the beneficiaries in conformity with the Consortium Agreement, will also ensure that continuous dissemination and exploitation activities are planned and running. Furthermore will take care of the implementation of a dedicated web site as a primary dissemination vehicle for programme, project, and technology and product data to the wide audience and the stakeholders.

Intellectual Property Provisions

The details about the IP management will be regulated by the Consortium Agreement signed among all the parties at the beginning of the contract grant stating, as it is usual for most CAs, that both the knowledge and the technology has to be property of the contractor generating it. Where several contractors will have jointly carried out work generating the knowledge and / or the technology, and where their respective share of the work cannot be assessed, they will have joint ownership of such knowledge or technology and will be entitled to use and license such knowledge without owing any financial compensation each other.

In summary:

- Consortium members will undertake to keep confidential information disclosed to them by other members.
- Results will not be published until patent opportunities has been assessed and agreed.
- Designed inventors will be as determined by applicable patent law.
- Where IP arising from this project is derived from the contribution of one single partner, that partner will own the IP.
- Where IP arising from this project is derived from the contribution of more than one partner, the IP will be owned by all contributing partners. All contributing partners will share in any income derived from the IP in proportion to their contribution to the IP.
- All background IP will remain the property of the originator and no rights to commercialise this background are granted to other parties.
- Access will be provided to background IP on reasonable terms where required for exploitation of foreground IP.
- Each party may continue to use the knowledge generated in their own research.

Where partners are interested in developing patent applications for their specific work, this will be done by the relevant partner only.

b) Communication activities

Dedicated communication strategy will be defined within the Consortium with the final goal to generate and raise the awareness and the interest about the project inside the community and the stakeholders, and to disseminate the relevance of the technological efforts addressed in terms of environmental impact and societal challenges.

Aside, on top of standard dissemination activities within the Consortium a dedicated Communication Team in constant contact with the Project Office will be in charge of the edition of a public and internal newsletter including up-to-date progress reports and sharing the lessons learned.

Below the Table 10 highlighting the main actions:

Table 10 Communication Activities

Communication Activities	Timing	Addressed Community	Owner
Communication activities definition and owner inside the Consortium	M1 Project Kick Off	<ul style="list-style-type: none"> Internal to Partners External 	Consortium
WEB SITE	M3	WW	ST-I
News Letter	Each 6 Months: Progress Report and lesson learned	Distributed to the distribution list of Partners, WEB Site subscribers and Social Followers	Program Office & Communication Team
CONTEXT for technical research paper	M20, M36 International Workshop	PHDs Researchers SMEs	Scientific Committee

WEBSITE and Collaborative tool

The consortium will use an Extranet-based secure collaborative tool for effective and secured communication. The tool will be accessible, under secured access control, to the WInSiC4AP Project Manager, the partners and will also enable the PTC (Project Technologic Committee) to keep track of the progresses.

The collaborative tool includes the following modules:

- General information module:
This module providing general information on the project and technical and management including financial aspects objectives. A short newsletter will be published every three months in order to inform partners about the tasks progression, the scientific news related to the project (references, sites, etc). The newsletter will also give information and details about the agenda and organization of the coming meetings and finally the possibilities for other collaborative opportunities.
- Secure message exchange module between partners:
All partners will have access to this module. All the messages related to the project will be collected in the same baseline, this allowing a better tracking and follow-up of information. The partners will also have access to a calendar settling meeting dates, workflow and reporting deadlines.
- Secure exchange document module:
All partners will have access to this module, with the project manager to control the access lists and eventually restrict documentation to certain subsets or individuals. The module will allow, in a controlled and secure environment, the publication of meeting minutes, technical reports, consolidated annual reports and other useful and/or confidential documents.

- Kanban Board module:
Project Office will easily track the workflow so that all partners will be constantly aware of the status of various tasks in a graphic way.
- Coordinating common publications and patent activities:
A 'knowledge database' will be created with publications, documented procedures, strategies, research proposals and regular research reports.

A special section of the website will be available to public access. It will contain info on Consortium members and on current research activities, a calendar of public scientific events. In addition to these, a strong effort will be dedicated to the dissemination of public knowledge outside the consortium, through technical press releases, scientific international fairs & conferences, journals and conference publications.

3. Implementation

3.1 Work plan — Work packages, deliverables and milestones

3.1.1 Brief presentation of the overall structure of the work plan

WInSiC4AP overall WPs structure & interconnections are pictured in the figure 39:

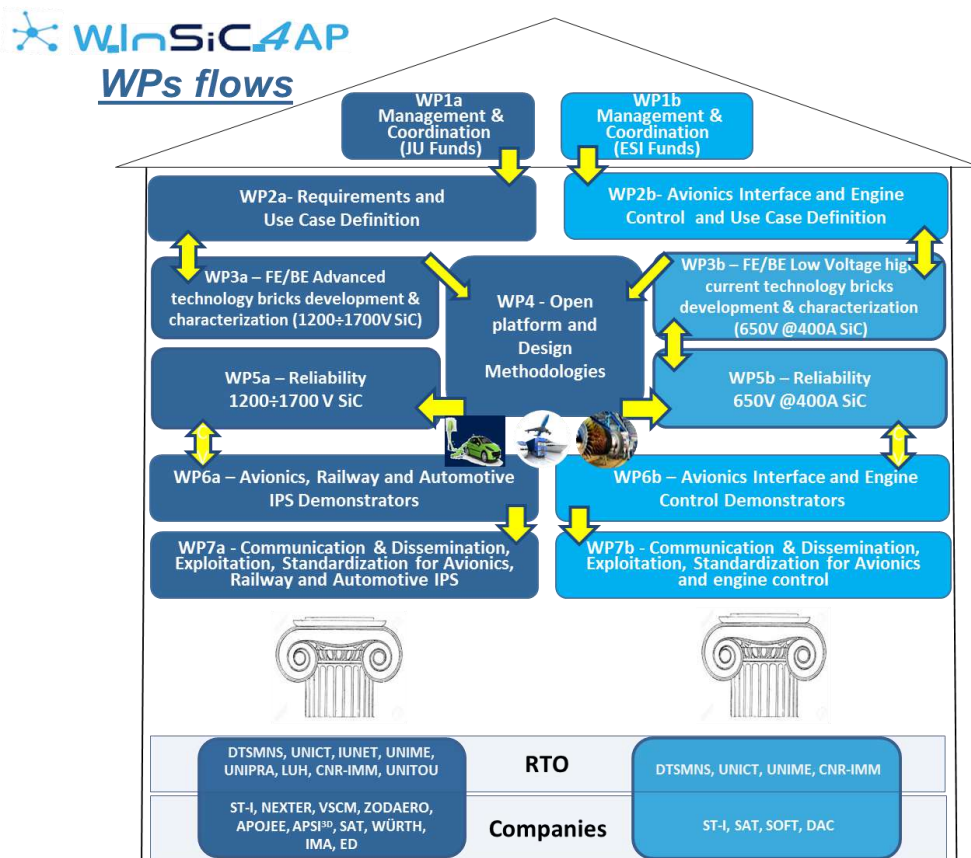

Figure 39 WInSiC4AP Work plan

WInSiC4AP is a challenging project involving:

- 20 partners, 6 large companies, 6 SMEs, 8 universities and research centers
- 4 EU countries (France, Germany, Italy and Czech Republic)
- 8 target application demonstrators encompassing power and control hardware, control firmware, integration of passive components (magnetics, capacitors)
- Components design and prototyping according to requirements about reliability and failure modelling analysis: (passive and active components SiC Diodes and Mosfets, driver);

- Technology processes innovation like trench will rejuvenate present SiC to better performances. Power wafer scale packaging, innovative materials and substrates, dual cooling module.

It will therefore require a strong alignment among partners and an effective project management office in order to ensure that activities are triggered by demonstrators' milestones, managing and exploiting the two WInSiC4AP pillars funded by JU/National funding and ESIF funding.

In order to support and facilitate the project management as well as the research project related processes of innovation and technology transfer among participants within the adopted Open Innovation approach, there will be used tools and useful platforms.

These tools (configured to provide the necessary confidentiality and timely sharing of information, technical notes and deliverable for an authentic model of knowledge management) will be used for project planning and control with details on individual tasks, their progress reports and the related costs incurred. . This approach will allow the complete collaborative process in each task, and support information and technology transfer where appropriate and within the agreed rules and confidentiality limitations.

Relating to the research activities, strategies have also been implemented in order to preserve the successful execution:

- Two design cycles and two iterations have been identified for each demonstrator, allowing the tuning of the components across the demonstrator design;
 - o A first iteration at the beginning of the project by identifying detailed requirements to be implemented in two design cycles;
 - o a second iteration at the end of first design cycle to tune design and components on the minimum design requirements
- Critical path and risks have been identified (Table 3.2b: Critical risks for implementation);
- GANTT re-validation will be performed at each critical path assessment;
- A "Minimum Viable Product" validation criteria will be identified for each demonstrator.
- Dedicated WPs to manage and exploit ESIF activities/results avoiding substitution of required national contributions by other European sources.

Find below a brief presentation of Workpackages:

WP1a and WP1b: Management & Coordination

The goal of WP1a and WP1b is to ensure that the overall objectives of the WInSiC4AP project, as outlined in the proposal, will be achieved within the planned time and budget. This requires a permanent and close monitoring with all partners in order to enable the project coordinator to control the work progress and act as interface and catalyst for the project under the ECSEL JU rules. It will also work to guarantee synchronized timing for contract negotiation and signature minimizing the risk of funding coming from different sources (JU, national and ESIF) and identifying/implementing the best mitigation measures.

In particular WP1a (under JU funds) is dedicated to FE/BE Advanced technology bricks development & characterization (1200÷1700V SiC) for "Avionics, Railway and Automotive IPS"; the WP1b (under EFI Funds) is dedicated to FE/BE Low Voltage high current technology bricks development & characterization (650V @400A SiC) for "Avionics and engine control".

In these WP1a and WP1b, beside the standard management activities, a risk analysis will be also performed to start the relevant actions to mitigate all other risks. Moreover the program management will identify, according to the critical paths, the various iterations for GANTT validation. A permanent and close monitoring with all partners is required in order to enable the project coordinator to control the work progress and act as interface and catalyst synchronization with ECSEL JU and/or National Authority.

WP2a: Requirements and Use Case Definition

WInSiC4AP will be driven by application requirements analysed by TIER1 and TIER2 on Automotive, Railway, Aerospace directly linked to market roadmap established by OEMs. The workplan will be based on high level specifications addressing the main challenges.

WP2b: Avionics Interface and Engine Control and Use Case Definition

This ESIF WP will be driven by application requirements analysed by DAC partner on Business and General Aviation Avionics directly linked to market roadmap. The workplan will be based on high level specifications addressing the main challenges.

WP3a: FE/BE Advanced technology bricks development & characterization (1200÷1700V SiC)

Relevant building blocks will be identified, developed and characterized: packaging options, advanced power module, passive components will be developed for the demonstrators.

Two major design cycles will be performed in synchronization with demonstrators' development.

Technological developments and prototypes of components for the demonstrator will be the outcome of WP3a.

WP3b: FE/BE Low Voltage high current technology bricks development & characterization (650V @400A SiC)

Relevant building blocks will be identified, developed and characterized: packaging options, advanced power module will be developed for the demonstrators.

Two major design cycles will be performed in synchronization with demonstrators' development.

Technological developments and prototypes of components for the demonstrator will be the outcome of WP3b.

WP4: Open platform and Design Methodologies

Requirements, reliability and demonstrators will drive the identifications and development of an innovative approach with two objectives:

- Identification of reference designs for common platform across the industries;
- Definition of a co-development design methodology for reliable applications across the value chain.

WP5a: Reliability 1200÷1700V SiC

Reliability will be assessed particularly addressing the relevant standardization committees.

Different analysis will be carried on by exploiting partners' competencies and sharing and integration of different practices will be done to explore opportunities for defining a standard approach for SiC.

WP5b: Reliability 650V @400A SiC

Reliability will be assessed particularly addressing the relevant standardization committees.

Different analysis will be carried on by exploiting partners' competencies and sharing and integration of different practices will be done to explore opportunities for defining a standard approach for SiC.

WP6a: Avionics, Railway and Automotive IPS and others Demonstrators

The activities for demonstrators manufacturing will require different steps: circuit design and implementation of topologies and complete architectures, design of hardware and software control integration and assembling (Power Module, Passive components), testing and validation. Also in some cases design of discrete drivers will be part of the design flow.

The value chain will be assessed at the beginning of each task as per the figure below per each of the demonstrator.



WP6b: Avionics Interface and Engine Control Demonstrators

The activities for Aerospace demonstrators manufacturing will require different steps: circuit design and implementation of topologies and complete architectures, design of hardware and software control integration and assembling (Power Module, Passive components), testing and validation. Also in some cases, design of discrete drivers will be part of the design flow.

The value chain will be assessed at the beginning of each task as per the figure below per each of the demonstrator



WP7a – Communication & Dissemination, Exploitation, Standardization for Avionics, Railway and Automotive IPS

Strong communication activities will be carried on to disseminate the progresses and the results obtained during the project duration. Dissemination phase will take place in networks and conference events with a special focus in Europe. The participation of industrial partners in standardization committees is foreseen.

WP7b – Communication & Dissemination, Exploitation, Standardization for Avionics and engine control

Strong communication activities will be carried on to disseminate the progresses and the results obtained during the project duration. Dissemination phase will take place in networks and conference events with complementary approach to WP7a. The Tasks will be performed with specific activities targeting less developed region at national and European level to strengthen European Cohesion Policies.

3.1.2 Macro Planning Schedule

The macro planning schedule is described below and detailed inside the single work package description.

		YEAR 1												YEAR 2												YEAR 3																			
		1	2	3	4	5	6	7	8	9	10	11	12	13	14	15	16	17	18	19	20	21	22	23	24	25	26	27	28	29	30	31	32	33	34	35	36								
WP1a	Management and Coordination FE/BE for Avionics, Railway and Automotive IPS (JU Funds)	[Shaded]																																											
1a.1	Implementation of project management Structures	[Blue]	[Blue]	[Blue]	[Blue]	[Blue]	[Blue]	[Blue]	[Blue]	[Blue]	[Blue]	[Blue]	[Blue]	[Blue]	[Blue]	[Blue]	[Blue]	[Blue]	[Blue]	[Blue]	[Blue]	[Blue]	[Blue]	[Blue]	[Blue]	[Blue]	[Blue]	[Blue]	[Blue]	[Blue]	[Blue]	[Blue]	[Blue]	[Blue]	[Blue]	[Blue]	[Blue]	[Blue]	[Blue]	[Blue]					
1a.2	Project management	[Blue]	[Blue]	[Blue]	[Blue]	[Blue]	[Blue]	[Blue]	[Blue]	[Blue]	[Blue]	[Blue]	[Blue]	[Blue]	[Blue]	[Blue]	[Blue]	[Blue]	[Blue]	[Blue]	[Blue]	[Blue]	[Blue]	[Blue]	[Blue]	[Blue]	[Blue]	[Blue]	[Blue]	[Blue]	[Blue]	[Blue]	[Blue]	[Blue]	[Blue]	[Blue]	[Blue]	[Blue]	[Blue]	[Blue]	[Blue]				
1a.3	IPR management	[Blue]	[Blue]	[Blue]	[Blue]	[Blue]	[Blue]	[Blue]	[Blue]	[Blue]	[Blue]	[Blue]	[Blue]	[Blue]	[Blue]	[Blue]	[Blue]	[Blue]	[Blue]	[Blue]	[Blue]	[Blue]	[Blue]	[Blue]	[Blue]	[Blue]	[Blue]	[Blue]	[Blue]	[Blue]	[Blue]	[Blue]	[Blue]	[Blue]	[Blue]	[Blue]	[Blue]	[Blue]	[Blue]	[Blue]	[Blue]	[Blue]			
1a.4	Coordination	[Blue]	[Blue]	[Blue]	[Blue]	[Blue]	[Blue]	[Blue]	[Blue]	[Blue]	[Blue]	[Blue]	[Blue]	[Blue]	[Blue]	[Blue]	[Blue]	[Blue]	[Blue]	[Blue]	[Blue]	[Blue]	[Blue]	[Blue]	[Blue]	[Blue]	[Blue]	[Blue]	[Blue]	[Blue]	[Blue]	[Blue]	[Blue]	[Blue]	[Blue]	[Blue]	[Blue]	[Blue]	[Blue]	[Blue]	[Blue]	[Blue]			
WP1b	Management and Coordination FE/BE Low Voltage for Avionics & Engine control (ESI Funds)	[Shaded]																																											
1b.1	Implementation of project management Structures	[Blue]	[Blue]	[Blue]	[Blue]	[Blue]	[Blue]	[Blue]	[Blue]	[Blue]	[Blue]	[Blue]	[Blue]	[Blue]	[Blue]	[Blue]	[Blue]	[Blue]	[Blue]	[Blue]	[Blue]	[Blue]	[Blue]	[Blue]	[Blue]	[Blue]	[Blue]	[Blue]	[Blue]	[Blue]	[Blue]	[Blue]	[Blue]	[Blue]	[Blue]	[Blue]	[Blue]	[Blue]	[Blue]	[Blue]	[Blue]	[Blue]			
1b.2	Project management	[Blue]	[Blue]	[Blue]	[Blue]	[Blue]	[Blue]	[Blue]	[Blue]	[Blue]	[Blue]	[Blue]	[Blue]	[Blue]	[Blue]	[Blue]	[Blue]	[Blue]	[Blue]	[Blue]	[Blue]	[Blue]	[Blue]	[Blue]	[Blue]	[Blue]	[Blue]	[Blue]	[Blue]	[Blue]	[Blue]	[Blue]	[Blue]	[Blue]	[Blue]	[Blue]	[Blue]	[Blue]	[Blue]	[Blue]	[Blue]	[Blue]	[Blue]		
1b.3	Coordination	[Blue]	[Blue]	[Blue]	[Blue]	[Blue]	[Blue]	[Blue]	[Blue]	[Blue]	[Blue]	[Blue]	[Blue]	[Blue]	[Blue]	[Blue]	[Blue]	[Blue]	[Blue]	[Blue]	[Blue]	[Blue]	[Blue]	[Blue]	[Blue]	[Blue]	[Blue]	[Blue]	[Blue]	[Blue]	[Blue]	[Blue]	[Blue]	[Blue]	[Blue]	[Blue]	[Blue]	[Blue]	[Blue]	[Blue]	[Blue]	[Blue]	[Blue]		
WP2a	Requirements and Use Case Definition	[Shaded]																																											
2a.1	On board battery charger for PHEV or BEV	[Blue]	[Blue]	[Blue]	[Blue]	[Blue]	[Blue]	[Blue]	[Blue]	[Blue]	[Blue]	[Blue]	[Blue]	[Blue]	[Blue]	[Blue]	[Blue]	[Blue]	[Blue]	[Blue]	[Blue]	[Blue]	[Blue]	[Blue]	[Blue]	[Blue]	[Blue]	[Blue]	[Blue]	[Blue]	[Blue]	[Blue]	[Blue]	[Blue]	[Blue]	[Blue]	[Blue]	[Blue]	[Blue]	[Blue]	[Blue]	[Blue]			
2a.2	DC-DC Converters for HEV, BEV and FC	[Blue]	[Blue]	[Blue]	[Blue]	[Blue]	[Blue]	[Blue]	[Blue]	[Blue]	[Blue]	[Blue]	[Blue]	[Blue]	[Blue]	[Blue]	[Blue]	[Blue]	[Blue]	[Blue]	[Blue]	[Blue]	[Blue]	[Blue]	[Blue]	[Blue]	[Blue]	[Blue]	[Blue]	[Blue]	[Blue]	[Blue]	[Blue]	[Blue]	[Blue]	[Blue]	[Blue]	[Blue]	[Blue]	[Blue]	[Blue]	[Blue]	[Blue]		
2a.3	Intelligent Power Switch (IPS)	[Blue]	[Blue]	[Blue]	[Blue]	[Blue]	[Blue]	[Blue]	[Blue]	[Blue]	[Blue]	[Blue]	[Blue]	[Blue]	[Blue]	[Blue]	[Blue]	[Blue]	[Blue]	[Blue]	[Blue]	[Blue]	[Blue]	[Blue]	[Blue]	[Blue]	[Blue]	[Blue]	[Blue]	[Blue]	[Blue]	[Blue]	[Blue]	[Blue]	[Blue]	[Blue]	[Blue]	[Blue]	[Blue]	[Blue]	[Blue]	[Blue]	[Blue]	[Blue]	
2a.4	Requirements and use case for High efficiency Bidirectional SiC-based Power Converter for V2G/V2H applications	[Blue]	[Blue]	[Blue]	[Blue]	[Blue]	[Blue]	[Blue]	[Blue]	[Blue]	[Blue]	[Blue]	[Blue]	[Blue]	[Blue]	[Blue]	[Blue]	[Blue]	[Blue]	[Blue]	[Blue]	[Blue]	[Blue]	[Blue]	[Blue]	[Blue]	[Blue]	[Blue]	[Blue]	[Blue]	[Blue]	[Blue]	[Blue]	[Blue]	[Blue]	[Blue]	[Blue]	[Blue]	[Blue]	[Blue]	[Blue]	[Blue]	[Blue]	[Blue]	
2a.5	Inverter for Avionics Applications	[Blue]	[Blue]	[Blue]	[Blue]	[Blue]	[Blue]	[Blue]	[Blue]	[Blue]	[Blue]	[Blue]	[Blue]	[Blue]	[Blue]	[Blue]	[Blue]	[Blue]	[Blue]	[Blue]	[Blue]	[Blue]	[Blue]	[Blue]	[Blue]	[Blue]	[Blue]	[Blue]	[Blue]	[Blue]	[Blue]	[Blue]	[Blue]	[Blue]	[Blue]	[Blue]	[Blue]	[Blue]	[Blue]	[Blue]	[Blue]	[Blue]	[Blue]	[Blue]	
2a.6	Overall Synthesis of WP2a activities for WP3: specifications standardization at components chips, passive, module	[Blue]	[Blue]	[Blue]	[Blue]	[Blue]	[Blue]	[Blue]	[Blue]	[Blue]	[Blue]	[Blue]	[Blue]	[Blue]	[Blue]	[Blue]	[Blue]	[Blue]	[Blue]	[Blue]	[Blue]	[Blue]	[Blue]	[Blue]	[Blue]	[Blue]	[Blue]	[Blue]	[Blue]	[Blue]	[Blue]	[Blue]	[Blue]	[Blue]	[Blue]	[Blue]	[Blue]	[Blue]	[Blue]	[Blue]	[Blue]	[Blue]	[Blue]	[Blue]	
WP2b	Avionics Interface and Engine Control and Use Case Definition	[Shaded]																																											
2b.1	LiPo Interface	[Blue]	[Blue]	[Blue]	[Blue]	[Blue]	[Blue]	[Blue]	[Blue]	[Blue]	[Blue]	[Blue]	[Blue]	[Blue]	[Blue]	[Blue]	[Blue]	[Blue]	[Blue]	[Blue]	[Blue]	[Blue]	[Blue]	[Blue]	[Blue]	[Blue]	[Blue]	[Blue]	[Blue]	[Blue]	[Blue]	[Blue]	[Blue]	[Blue]	[Blue]	[Blue]	[Blue]	[Blue]	[Blue]	[Blue]	[Blue]	[Blue]	[Blue]	[Blue]	
2b.2	Engine Controller-Inverter	[Blue]	[Blue]	[Blue]	[Blue]	[Blue]	[Blue]	[Blue]	[Blue]	[Blue]	[Blue]	[Blue]	[Blue]	[Blue]	[Blue]	[Blue]	[Blue]	[Blue]	[Blue]	[Blue]	[Blue]	[Blue]	[Blue]	[Blue]	[Blue]	[Blue]	[Blue]	[Blue]	[Blue]	[Blue]	[Blue]	[Blue]	[Blue]	[Blue]	[Blue]	[Blue]	[Blue]	[Blue]	[Blue]	[Blue]	[Blue]	[Blue]	[Blue]	[Blue]	[Blue]
2b.3	Overall Synthesis of WP2b activities for WP3: specifications standardization at components chips, passive, module	[Blue]	[Blue]	[Blue]	[Blue]	[Blue]	[Blue]	[Blue]	[Blue]	[Blue]	[Blue]	[Blue]	[Blue]	[Blue]	[Blue]	[Blue]	[Blue]	[Blue]	[Blue]	[Blue]	[Blue]	[Blue]	[Blue]	[Blue]	[Blue]	[Blue]	[Blue]	[Blue]	[Blue]	[Blue]	[Blue]	[Blue]	[Blue]	[Blue]	[Blue]	[Blue]	[Blue]	[Blue]	[Blue]	[Blue]	[Blue]	[Blue]	[Blue]	[Blue]	[Blue]
WP3a	FE/BE Advanced technology bricks development & characterization (1200-1700V SiC)	[Shaded]																																											
3a.1	FE/BE development and Building blocks for 1200V SiC device	[Blue]	[Blue]	[Blue]	[Blue]	[Blue]	[Blue]	[Blue]	[Blue]	[Blue]	[Blue]	[Blue]	[Blue]	[Blue]	[Blue]	[Blue]	[Blue]	[Blue]	[Blue]	[Blue]	[Blue]	[Blue]	[Blue]	[Blue]	[Blue]	[Blue]	[Blue]	[Blue]	[Blue]	[Blue]	[Blue]	[Blue]	[Blue]	[Blue]	[Blue]	[Blue]	[Blue]	[Blue]	[Blue]	[Blue]	[Blue]	[Blue]	[Blue]	[Blue]	
3a.2	FE/BE development and Building blocks for 1700V SiC device	[Blue]	[Blue]	[Blue]	[Blue]	[Blue]	[Blue]	[Blue]	[Blue]	[Blue]	[Blue]	[Blue]	[Blue]	[Blue]	[Blue]	[Blue]	[Blue]	[Blue]	[Blue]	[Blue]	[Blue]	[Blue]	[Blue]	[Blue]	[Blue]	[Blue]	[Blue]	[Blue]	[Blue]	[Blue]	[Blue]	[Blue]	[Blue]	[Blue]	[Blue]	[Blue]	[Blue]	[Blue]	[Blue]	[Blue]	[Blue]	[Blue]	[Blue]	[Blue]	[Blue]
3a.5	Gate drive transformers	[Blue]	[Blue]	[Blue]	[Blue]	[Blue]	[Blue]	[Blue]	[Blue]	[Blue]	[Blue]	[Blue]	[Blue]	[Blue]	[Blue]	[Blue]	[Blue]	[Blue]	[Blue]	[Blue]	[Blue]	[Blue]	[Blue]	[Blue]	[Blue]	[Blue]	[Blue]	[Blue]	[Blue]	[Blue]	[Blue]	[Blue]	[Blue]	[Blue]	[Blue]	[Blue]	[Blue]	[Blue]	[Blue]	[Blue]	[Blue]	[Blue]	[Blue]	[Blue]	[Blue]
WP3b	FE/BE Low Voltage high current technology bricks development & characterization (650V @400A SiC)	[Shaded]																																											
3b.1	FE/BE development and Building blocks for 650V SiC devices	[Blue]	[Blue]	[Blue]	[Blue]	[Blue]	[Blue]	[Blue]	[Blue]	[Blue]	[Blue]	[Blue]	[Blue]	[Blue]	[Blue]	[Blue]	[Blue]	[Blue]	[Blue]	[Blue]	[Blue]	[Blue]	[Blue]	[Blue]	[Blue]	[Blue]	[Blue]	[Blue]	[Blue]	[Blue]	[Blue]	[Blue]	[Blue]	[Blue]	[Blue]	[Blue]	[Blue]	[Blue]	[Blue]	[Blue]	[Blue]	[Blue]	[Blue]	[Blue]	[Blue]
3b.2	Process integration for innovative Power Module, development and prototyping	[Blue]	[Blue]	[Blue]	[Blue]	[Blue]	[Blue]	[Blue]	[Blue]	[Blue]	[Blue]	[Blue]	[Blue]	[Blue]	[Blue]	[Blue]	[Blue]	[Blue]	[Blue]	[Blue]	[Blue]	[Blue]	[Blue]	[Blue]	[Blue]	[Blue]	[Blue]	[Blue]	[Blue]	[Blue]	[Blue]	[Blue]	[Blue]	[Blue]	[Blue]	[Blue]	[Blue]	[Blue]	[Blue]	[Blue]	[Blue]	[Blue]	[Blue]	[Blue]	[Blue]
WP4	Open platform and Design Methodologies	[Shaded]																																											
4.1	Design and application advanced methodologies	[Blue]	[Blue]	[Blue]	[Blue]	[Blue]	[Blue]	[Blue]	[Blue]	[Blue]	[Blue]	[Blue]	[Blue]	[Blue]	[Blue]	[Blue]	[Blue]	[Blue]	[Blue]	[Blue]	[Blue]	[Blue]	[Blue]	[Blue]	[Blue]	[Blue]	[Blue]	[Blue]	[Blue]	[Blue]	[Blue]	[Blue]	[Blue]	[Blue]	[Blue]	[Blue]	[Blue]	[Blue]	[Blue]	[Blue]	[Blue]	[Blue]	[Blue]	[Blue]	[Blue]
4.2	From Specific Requirements to Open Platform	[Blue]	[Blue]	[Blue]	[Blue]	[Blue]	[Blue]	[Blue]	[Blue]	[Blue]	[Blue]	[Blue]	[Blue]	[Blue]	[Blue]	[Blue]	[Blue]	[Blue]	[Blue]	[Blue]	[Blue]	[Blue]	[Blue]	[Blue]	[Blue]	[Blue]	[Blue]	[Blue]	[Blue]	[Blue]	[Blue]	[Blue]	[Blue]	[Blue]	[Blue]	[Blue]	[Blue]	[Blue]	[Blue]	[Blue]	[Blue]	[Blue]	[Blue]	[Blue]	[Blue]
WP5a	Reliability 1200-1700V SiC	[Shaded]																																											
5a.1	Device characterization and parasitic effects evaluation	[Blue]	[Blue]	[Blue]	[Blue]	[Blue]	[Blue]	[Blue]	[Blue]	[Blue]	[Blue]	[Blue]	[Blue]	[Blue]	[Blue]	[Blue]	[Blue]	[Blue]	[Blue]	[Blue]	[Blue]	[Blue]	[Blue]	[Blue]	[Blue]	[Blue]	[Blue]	[Blue]	[Blue]	[Blue]	[Blue]	[Blue]	[Blue]	[Blue]	[Blue]	[Blue]	[Blue]	[Blue]	[Blue]	[Blue]	[Blue]	[Blue]	[Blue]	[Blue]	[Blue]
5a.2	Reliability investigation of devices	[Blue]	[Blue]	[Blue]	[Blue]	[Blue]	[Blue]	[Blue]	[Blue]	[Blue]	[Blue]	[Blue]	[Blue]	[Blue]	[Blue]	[Blue]	[Blue]	[Blue]	[Blue]	[Blue]	[Blue]	[Blue]	[Blue]	[Blue]	[Blue]	[Blue]	[Blue]	[Blue]	[Blue]	[Blue]	[Blue]	[Blue]	[Blue]	[Blue]	[Blue]	[Blue]	[Blue]	[Blue]	[Blue]	[Blue]	[Blue]	[Blue]	[Blue]	[Blue]	[Blue]
5a.3	Failure Analysis and physical modelling	[Blue]	[Blue]	[Blue]	[Blue]	[Blue]	[Blue]	[Blue]	[Blue]	[Blue]	[Blue]	[Blue]	[Blue]	[Blue]	[Blue]	[Blue]	[Blue]	[Blue]	[Blue]	[Blue]	[Blue]	[Blue]	[Blue]	[Blue]	[Blue]	[Blue]	[Blue]	[Blue]	[Blue]	[Blue]	[Blue]	[Blue]	[Blue]	[Blue]	[Blue]	[Blue]	[Blue]	[Blue]	[Blue]	[Blue]	[Blue]	[Blue]	[Blue]	[Blue]	[Blue]
WP5b	Reliability 650V @400A SiC	[Shaded]																																											

Table 3.1a: Work package description (removed)

WP1.a Management and Coordination FE/BE for Avionics, Railway and Automotive IPS(JU Funds)

Objectives

The goal of WP1.a, dedicated to FE/BE Advanced technology bricks development & characterization (1200÷1700V) SiC for “Avionics, Railway and Automotive IPS”, is to ensure that the overall objectives of the WInSiC4AP project, as outlined in the proposal, will be achieved within the planned time and budget. This requires a permanent and close monitoring with all partners in order to enable the project coordinator to control the work progress and act as interface and catalyst for the project under the ECSEL JU rules. It will also works to guarantee synchronized timing for contract negotiation and signature minimizing the risk of funding coming from different sources (JU, national and ESIF) and identifying/implementing the best mitigation measures. In this WP, beside the standard management activities, a risk analysis will be also performed to start the relevant actions to mitigate risks. Moreover the program management will identify, according to the critical paths, the various iterations for GANTT validation. A permanent and close monitoring with all partners is required in order to enable the project coordinator to control the work progress and act as interface and catalyst synchronization with ECSEL JU and/or National Authority.

Objective of this work package is to ensure that all needed actions are highlighted to identify the critical path of the project and to find the necessary amendments in the actions for the identified and/or occurring risks or any other unforeseen event.

Specific structure has been defined as described in the Program Management Section 3.2.

The main objectives of WP1a are to provide:

- Project Management
- IPR Management
- ECSEL JU rules compliance
- Communication with ECSEL JU during the project’s execution

Description of work

A risk analysis will be performed to start the relevant actions to mitigate risks. Moreover the program management will identify, according to the critical paths, the various iterations for GANTT validation. Set-up and implementation of all the project structures; organization of the project kick-off meeting and of the periodic reviews, management and technical meetings; execution of day-by-day project administration and progress monitoring; technical project steering; identification of potential risks and definition of appropriate recovery plans; monitoring of the performance of the Consortium partners; implementation of corrective actions to cope with possible misbehaviours of some partners; definition of standards, procedures and templates regarding matters such as documentation and review procedures; preparation and delivery to the ECSEL JU of the required documents and reports; organization and preparation of the project review meetings; preparation of the Consortium Agreement which, among other matters, will set-up proper policy and guideline for intellectual property right (IPR) management, internally and externally to the Consortium, and it will set-up and manage the IPR management database.

Task 1a.1: Implementation of project management Structures

(DTSMNS leader, ST-I)

Task 1a.1 Start month T1, End Month T4

In this task, the project coordinator will set-up and implement the necessary project management structures for Automotive, Railway and Avionics in accordance with the governance model described in the relevant Section 3.2 to keep separated the 2 management WP1a and 1b. In addition, the project coordinator will convene the project kick-off meeting at the earliest convenience since the official start date of the project.

In order to facilitate the cooperation within the project and to foster a collaborative environment, the web site will be the preferred instrument to set up a collaboration workplace where all restricted information like deliverables and presentations for project reviews (accessible only to project member and EC reviewers and/or jointly agreed external parties) is stored. It will also contain confidential information – all partial and final results, working documents, presentations and articles. Project partners might also maintain their own intranet project web pages.

Task 1a.2: Project management

(DTSMNS leader, ST-I)

Task 1a.2 Start month T1, End Month T36

In this task, the project coordinator will perform the due project management activities in sync with all the partners, under JU fundings. Such activities are comprehensive of technical, strategic, administrative and financial actions, for an efficient, on-time execution of the project work and delivery of the related results. The restricted web site will be used as a repository for communication and documentation exchange among all the partners and JU. It will be linked from the project public web-site developed and maintained in the context of Dissemination.

Part of the project management is the duty of the project coordinator to be the primary contact point to the JU and the Project Officer for all the matters, technical and administrative, concerning the execution, progress and management of all project activities. Any action concerning communication to the JU as well as the exchange of material, technical, administrative and legal documents occurs in the context of this task.

Task 1a.3: IPR management

(DTSMNS leader, ST-I)

Task 1a.3 Start month T1, End Month T36

This task deals with the appropriate policies and rules for the management of background and foreground IP of the innovative technologies developed within WInSiC4AP in the context of the JU Funding activities. The policy rules will convey in the PCA (Project Consortium Agreement) in which the partners shall define the guidelines and criteria for information exchange of pre-existing know-how and within its annexes there will be the Initial release of the *IPR Management Database*. IPR management will be a continuous activity covering the entire project lifetime, collecting a list of reusable and non-reusable pre-existing know-how available at the start of the project, and new know-how generated by the R&D activities during the project.

Task 1a.4 Coordination

(DTSMNS)

Task 1a.4 Start month T1, End Month T36

This task deals with the appropriate policies and rules for the coordination activities, in order to submit to the Commission the technical and financial reports, submit the deliverables, submit the periodic reports within 60 days following the end of each reporting period, also submit the final report within 60 days following the end of the last reporting period, manage payment towards the beneficiaries, organize and participate in meetings, including those with external experts.

		YEAR 1												YEAR 2												YEAR 3														
		1	2	3	4	5	6	7	8	9	10	11	12	13	14	15	16	17	18	19	20	21	22	23	24	25	26	27	28	29	30	31	32	33	34	35	36			
WP1.a	Management and Coordination FE/BE for Avionics, Railway and Automotive (JU Funds) IPS																																							
1a.1	Implementation of project management structures																																							
1a.2	Project management																																							
1a.3	IPR management																																							
1a.4	Coordination																																							

WP1.b Management and Coordination FE/BE Low Voltage (650V @400A SiC) for “Avionics and engine control” (ESI Funds)

Objectives

The goal of WP1.b, dedicated to FE/BE Low Voltage high current technology bricks development & characterization (650V @400A SiC) for “Avionics and engine control”, is to ensure that the overall objectives of the WInSiC4AP project, as outlined in the proposal, will be achieved within the planned time and budget. This requires a permanent and close monitoring with all partners in order to enable the project coordinator to control the work progress and act as interface and catalyst for the project under the ECSEL JU rules. It will also works to guarantee synchronized timing for contract negotiation and signature minimizing the risk of funding coming from different sources (JU, national and ESIF) and identifying/implementing the best mitigation measures. In this WP, beside the standard management activities, a risk analysis will be also performed to start the relevant actions to mitigate risks. Moreover the program management will identify, according to the critical paths, the various iterations for GANTT validation. A permanent and close monitoring with all partners is required in order to enable the project coordinator to control the work progress and act as interface and catalyst synchronization with ECSEL JU and/or National Authority for the activities related to the component “FE/BE Low Voltage high current technology bricks development & characterization (650V @400A SiC) for Avionics and engine control”

Objective of this work package is to ensure that all needed actions are highlighted to identify the critical path of the project and to find the necessary amendments in the actions for the identified and/or occurring risks or any other unforeseen event.

Specific structure has been defined as described in the Program Management Section 3.2.

The main objectives of WP1b are to provide:

- Project Management for the activities related to FE/BE Low Voltage high current technology bricks development & characterization (650V @400A SiC) for Avionics and engine control
-
- ECSEL JU rules compliance
- Communication with ECSEL JU during the project’s execution

Description of work

A risk analysis will be performed to start the relevant actions to mitigate specific risks for the activities on FE/BE Low Voltage high current technology bricks development & characterization

(650V @400A SiC) for Avionics and engine control. Moreover, in this area, the program management will identify, according to the critical paths, the various iterations for GANTT validation, the set-up and implementation of all the project structures, the organization of the project kick-off meeting and of the periodic reviews, the management and technical meetings the identification of potential risks and definition of appropriate recovery plans, the ; monitoring of the performance of the Consortium partners; the implementation of corrective actions to cope with possible misbehaviours of some partners, the definition of standards, procedures and templates regarding matters such as documentation and review procedures, the specific preparation and delivery to the ECSEL JU of the required documents and reports.

**Task 1b.1: Implementation of project management Structures
(DTSMNS leader, ST-I)**

Task 1b.1 Start month T1, End Month T4

In this task, the project coordinator will set-up and implement the necessary project management structures for the FE/BE Low Voltage (650V @400A SiC) activities for Avionics and Engine Control, in accordance with the governance model described in the relevant Section 3.2 to keep separated the 2 management WP1a and WP1b. In addition, the project coordinator will convene the project kick-off meeting at the earliest convenience since the official start date of the project.

In order to facilitate the cooperation within the project and to foster a collaborative environment, the web site will be the preferred instrument to set up a collaboration workplace where all restricted information like deliverables and presentations for project reviews (accessible only to project member and EC reviewers and/or jointly agreed external parties) is stored. It will also contain confidential information – all partial and final results, working documents, presentations and articles. Project partners might also maintain their own intranet project web pages.

**Task 1b.2: Project management
(DTSMNS leader, ST-I)**

Task 1b.2 Start month T1, End Month T36

In this task, the project coordinator will perform the due project management for the low-voltage pillar for Avionics and engine control. Such activities are comprehensive of technical, strategic, administrative and financial actions, for an efficient, on-time execution of the project work and delivery of the related results.

Part of the project management is the duty of the project coordinator to be the primary contact point to the JU and the Project Officer for all the matters, technical and administrative, concerning the execution, progress and management of this part of the project. The actions concerning communication to the JU as well as the exchange of material, technical, administrative and legal documents occurs in the context of this task for the low-voltage pillar for Avionics and engine control .

**Task 1b.3 Coordination
(DTSMNS)**

Task 1b.4 Start month T1, End Month T36

This task deals with the appropriate policies and rules for the coordination activities of the FE/BE Low Voltage (650V @400A SiC) for Avionics and Engine Control.in order to collect the deliverables, , to submit the specific periodic reports, also submit the final report within 60 days following the end of the last reporting period, organize and participate in meetings, including those with external experts on this pillar .

One of the main limitations of the BEV is the autonomy. Thanks to impressive progress in battery cells technologies and manufacturing processes, power density is increased, and price of kWh is decreasing. This task aims to set-up prototype specification and target for OBC.

Partners will jointly investigate the feasibility of SiC based AC/DC converters for Battery Charging (BC) incorporating the largest possible number of components (inductors, capacitors, power switches, control systems) already present on the propulsion system of electric, or hybrid, vehicles. Those configurations which best exploit the key features of SiC MOSFETs, while minimizing cost and weight, will be first identified. A full evaluation of the selected topologies will be then accomplished through simulation and scaled prototypes, which will be assembled by UniME.

Development flow and timing:

Prototype specification, demonstrator targets T4 – T7

Component specifications: switches, drivers, passive T13 – T15 linked to WP3

Decision on packaging technology (i.e. double side cooling, low inductance) to be implemented

**Task 2a.2: DC-DC Converters for HEV, BEV and FC
(VSCM Leader, ST-I, UNICT, VSCM, aPSI^{3D}, WÜRTH, UNIME)**

Task 2a.2 Start month T1, End month T8

Innovative architecture of DCDC converter, reducing magnetic components, reducing output filtering and constraints on output mosfets, within improving efficiency up to 94-95%.

This task aims to set-up prototype specification and target for OBC.

Development flow and timing:

Prototype specification, demonstrator targets T1 – T4

Component specifications: switches, drivers, passive T5 – T8 linked to WP3

Decision on packaging technology (i.e. double side cooling, low inductance) to be implemented.

**Task 2a.3: Intelligent Power Switch (IPS)
(NEXTER Leader, ST-I, UNICT, NEXTER, VSCM, aPSI^{3D}, WÜRTH,)**

Task 2a.3 Start month T1, End Month T4

Two demonstrators will be designed :

- IPS for Railway : IPS-RA
- IPS for Aeronautics : IPS-AA

In both demonstrators the IPS will be based on a “Power part” and Driver Part. The development will include both modules and software control.

Moreover in the first case the demonstrator itself will be based on a module that will be designed in the WP3 and the rest of driver part specifically designed in the WP5.

A decision on the packaging technology (i.e. double side cooling, low inductance) to be implemented shall be made as an outcome of the common work.

Subtask 2a.3.1 IPS for Railway (IPS RA) : NEXTER creates the specifications

- Power Part
 - Multilevel topology to reach 3.3kV converter with SiC 1200V and 1700V
 - Module integration with double power density to be developed with either solution : wire bonding or aPSI^{3D}'s
 - Specific Passive components
- Driver part: functionalities required in the driver part (viewed at module level) will be précised by NEXTER into the specifications



EDEM3-Programmable EconoDual™
Electrical Series Optimized for Silicon Carbide (SiC) MOSFET Modules.
Implemented on A RHOM
BSM300D12P2E001 Sic Power Module (1,2 kV, 300A).

Example of expected IPS-RA demonstrator. In a simple face cooling concept.

- Subtask 2a.3.2 IPS for Avionics (IPS AA) : NEXTER creates the specifications
IPS-AA demonstrator will be used as an SSPC in AC (115V/220V) or HVDC (270V/540V) power networks.

- Power Part: The figure hereafter presents the power part of the actual IPS. Having the characteristics :
 - Bipolar IPS from NE : “Common source topology”
 - Use 8 Infineon CoolMos Power Switches: 650V / 30A: 45 mΩ IPB65R045C7.
 - Address 270VDC (+/-135VDC) Power Networks, embedded on aeronautical platforms

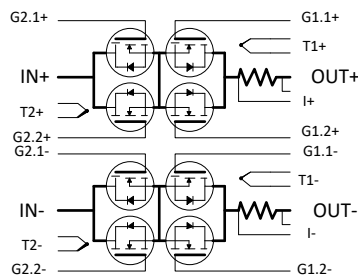
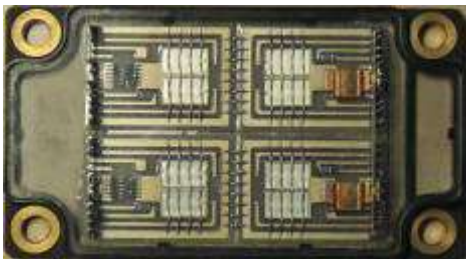

On the frame of WInSiC4AP the objective is to implement an IPS demonstrator adapted to implement an SSPC 3Phases.

- Driver Part : Two versions of control board are expected on the frame of WInSiC4AP project:
 - V1: Mockup implementing the global functionality. With gate drivers realized outside of power module, and using discrete components.
 - V2: More integrated prototype implementing the gate drivers inside the power module (on the same dimensions of mockup).

This demonstrator (see figure hereafter) will be implemented with a modular approach, including the steps :

- SiC Mosfet
- Specific passive components
- Gate Driver
- Integrated Module Solution with Gate Driver

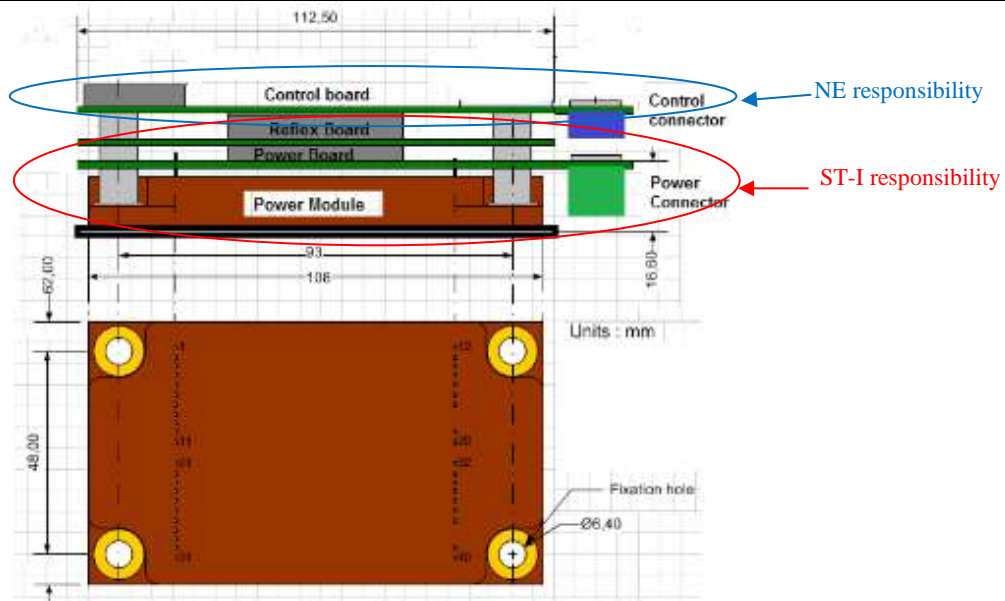

Task 2a.4: Requirements and use case for High efficiency Bidirectional SiC-based Power Converter for V2G/V2H applications

(ED Leader, ST-I, UNICT, IUNET, UNIME, ED)

Task 2a.4 Start month T1, End month T7

ED, in combination with ST-I and IUNET will develop the system architecture, system requirements and draw out the possible detailed use cases for this subsystem.

ED, taking advantage on its experience on DC charging systems for EVs, will coordinate the design and implementation of the system by using the state of the art technology of Silicon Carbide power transistors, provided by STMicroelectronics. The packaging solution will be defined accordingly.

UniCT and UniME will jointly investigate the feasibility of bidirectional AC/DC converters for Vehicle to Grid (V2G) applications incorporating the largest possible number of components (inductors, capacitors, power switches, control systems) already present on the propulsion system of electric, or hybrid, vehicles. Those configurations which best exploit the key features of SiC MOSFETs, while minimizing cost and weight, will be first identified. A full evaluation of the selected topologies will be then accomplished through simulation and scaled prototypes, which will be assembled by UniME.

Task 2a.5: Inverter for Avionics Applications

(ZODAERO Leader, ST-I, VSCM, ZODAERO, aPSI^{3D}, WÜRTH,)

Task 2a.5 Start month T1, End month T18

Aim of this task is to define prototype specification for components, passive and package to develop a 45 kW multi-purpose power converter, based on a six switch topology.

ZODAERO will drive components specification (passive components, active components and associated drivers) based on its demonstrator requirements. ZODAERO will provide static and dynamic electrical constraints, physical interfaces, environment, weight, etc. to help components standardization through the different compatible applications. Within the tasks of this work package, schedule and deliveries will also be discussed in order to minimize risks of planning and risks of components redefinition. There will be two batches of manufactured components, a first set of components for the first type of inverter demonstrator, then a second set of update components embedded into the second type of inverter demonstrator.

Task 2a.6: Overall Synthesis of WP2a activities for WP3: specifications standardization at components chips, passive, module (ST-I leader, ST-I, UNICT, UNIME, VSCM, ZODAERO, UNIPRA, aPSI3D, WÜRTH, IMA, ED)

Task 2a.6 Start month T18, End month T20

This is the core activity of the workpackage as it will deal with the identification of the minimum set of developments to allow the cross-fertilisation of demonstrators and the standardisation of the building blocks within the project to reach the highest volumes (and lowest costs) for the components.

The analysis will define:

- Number of variants of components
- Standardisation of specification
- Technology requirements for the Minimum Viable Product.

A set of bricks (Devices, Capacitor, Inductances, Package, transformer, EMI-choke, EMI cap) will be output of 2a specification and will realized in WP3a (see following sample table that will managed during project execution).

Demonstrator	Partner	Dev ices	Cap acito r	Inducta nces	Pack age	transfor mer	EMI- choke	EMI cap
1. On Board battery Charger for PHEV or BEV	VSCM	10			10			
2. Isolated DC-DC Converter for HEV, BEV and FC	VSCM							
3. Intelligent Power Switch (IPS-RA)	NEXTER	10			10			
4. Intelligent Power Switch (IPS-AA)	NEXTER	10			10			
5. High efficiency Bidirectional SiC-based Power Converter for V2G/V2H applications in a nano/microgrid scenario	ED							
6. Inverter for Avionics Applications	ZODAERO							

Table 2a.6 Samples to provide for each demonstrator

Partner contribution:

In this WP it will be defined the application requirements and the implementation of intelligent power switches and portable EV battery chargers in WP2a and WP5a in collaboration with ED.

Smart grid and demand response functions of electric vehicle chargers.

RTO and Universities will participate to requirements definition for both EMI filter and inverter software control and energy power optimization.

The electric engine control is demanded to a device that is located between the power sources and the engine connection group; it is also connected to the signal receiver for command inputs.

The purpose of this component is to modulate the power to provide to the engine in relation to the signal coming from the pilot via the receiver/flight control system.

Different types of controllers are applicable in relation to the different engine type. The basic requirements are high reliability, low weight and withstand extreme operating conditions. The voltage is between 100-200 V, the maximum current is 400 A, the maximum temperature for the equipment is 250° C; the minimum critical temperature is -50° C. In terms of loads 6g accelerations during operations and 9g for crash landing are applicable.

For DAC cluster some activities will be performed by REDAM member of linked third party CALTEC only on the ESI Funds (see 4.2 chapter).

For DTSMNS cluster the DEIM Department of the UNIPA associate member is a linked third party and will perform activities.

UNICT will participate to the definition of the control laws for the different electrical engines as well as, together with SOFT, the specifications of software control and energy power optimization.

Task 2b.3: Overall Synthesis of WP2b activities for WP3: specifications standardization at components chips, passive, module (ST-I leader, DTSMNS, ST-I, UNICT, SAT, DAC)

Task 2b.3 Start month T5, End Month T6

This is the core activity of the workpackage as it will deal with the identification of the minimum set of developments to allow the cross-fertilisation of demonstrators and the standardisation of the building blocks within the project to reach the highest volumes (and lowest costs) for the components .

The analysis will define:

- Number of variants of components
- Standardisation of specification
- Technology requirements for the Minimum Viable Product

A set of bricks (Devices, Capacitor, Inductances, Package, transformer, EMI-choke, EMI cap) will be output of 2b specification and will realized in WP3b (see following sample table that will managed during project execution).

Demonstrator	Partner	Devi ces	Capaci tor	Inductan ces	Packa ge	Transfor mer	EM I- cho ke	E M I ca p
7. LiPo Interface for Aerospace	DAC							
8. Engine Controller-Inverter for Aerospace	DAC							

Table 2b_samples

For DAC cluster some activities will be performed by REDAM member of linked third party CALTEC only on the ESI Funds (see 4.2 chapter).

For DTSMNS cluster the DEIM Department of the UNIPA associate member is a linked third party and will perform activities.

		YEAR 1						YEAR 2						YEAR 3																											
		1	2	3	4	5	6	7	8	9	10	11	12	13	14	15	16	17	18	19	20	21	22	23	24	25	26	27	28	29	30	31	32	33	34	35	36				
WP2b	Avionics Interface and Engine Control and Use Case Definition																																								
2b.1	LiPo Interface																																								
2b.2	Engine Controller-Inverter																																								
2b.3	Overall Synthesis of WP2b activities for WP3: specifications standardization at components chips, passive, module																																								

WP3a FE/BE Advanced technology brick development & characterization (1200÷1700V SiC)

<p>Objectives</p> <p>Front-end and back-end set up, advanced technology bricks development and relevant characterization for 1200÷1700V SiC application.</p> <p>DC-Link prototype components will be developed and defined. Power Inductors, Transformers and EMC components for the 6 project demonstrators will be defined.</p>
<p>Description of work</p> <p>Relevant building blocks will be identified, developed and characterized targeting 1200÷1700V SiC. Packaging options, advanced power module, passive components will be developed for the demonstrators. Two major design cycles will be performed in synchronization with demonstrators’ development. Technological developments and prototypes of components for the demonstrator will be the outcome for WP6a. Automotive applications need special development and characterization of SiC wafers as: front and back metallization schemes, as well as new interconnections materials and processes for die attachment, including the hard die attach (i.e. diffusion soldering, Silver sintering with and without pressure, ...), special wire bonding like in case of clad wires, and also ribbons, frontside clip that could be soldered or sintered on the structure. To find the best compromise in terms of thermo-electrical, mechanical and reliability performances, and looking at the best structure, a new co-design approach, including both the front-end and the back-end parts and their fusion, will be implemented by means and support of CAD analysis and Finite Elements Models (FEM) using multiphysics simulators, in order to produce predictive and optimized models, reducing time to fabrication and processes & designs debug.</p> <p>DC-Link and Snubber Components will be developed and defined making use of</p> <ul style="list-style-type: none"> - Film technology - Alu-Elko technology and - Anti-ferroelectric dielectric ceramic capacitor <p>where appropriate.</p> <p>To ensure high efficiency and avoid high switching losses, a low inductive DC-Link design is crucial. Beside a low self-inductance of the capacitors a low inductive connection to the semiconductors is mandatory to allow fast switching of the semiconductors during turn-off without having too high voltage overshoots.</p>

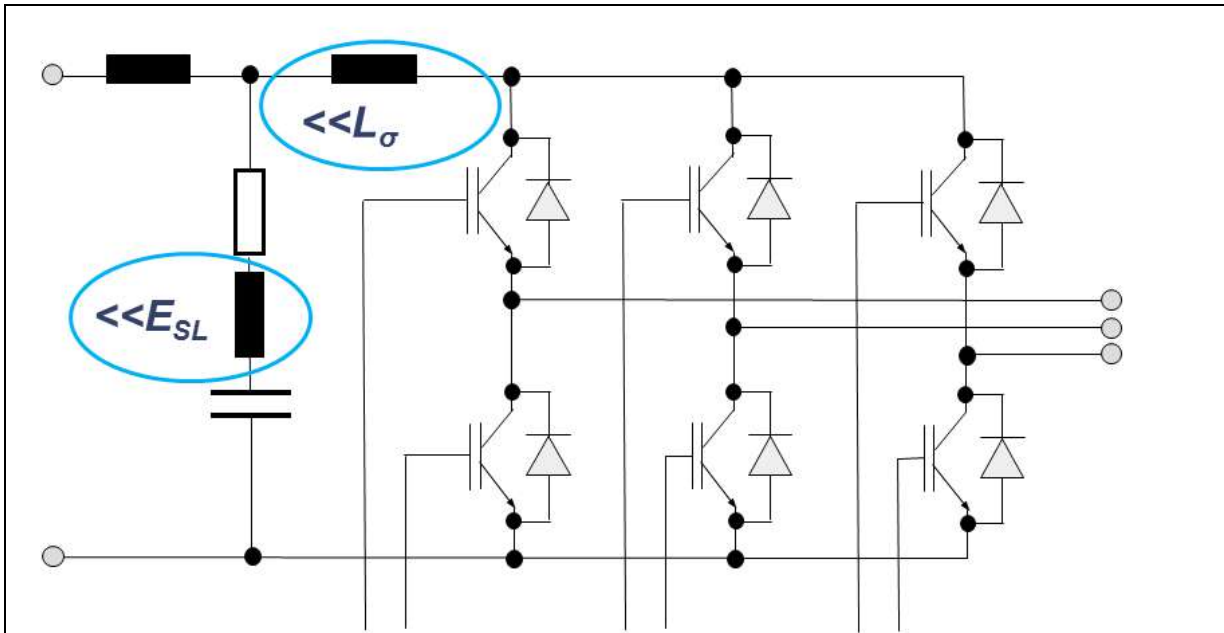

In this work package the appropriate capacitor technology will be chosen according to the requirements from work package 2a. Comparing different technologies over the voltage and capacitance range some areas are covered by more than one technology, whereas some areas are only covered by one technology:

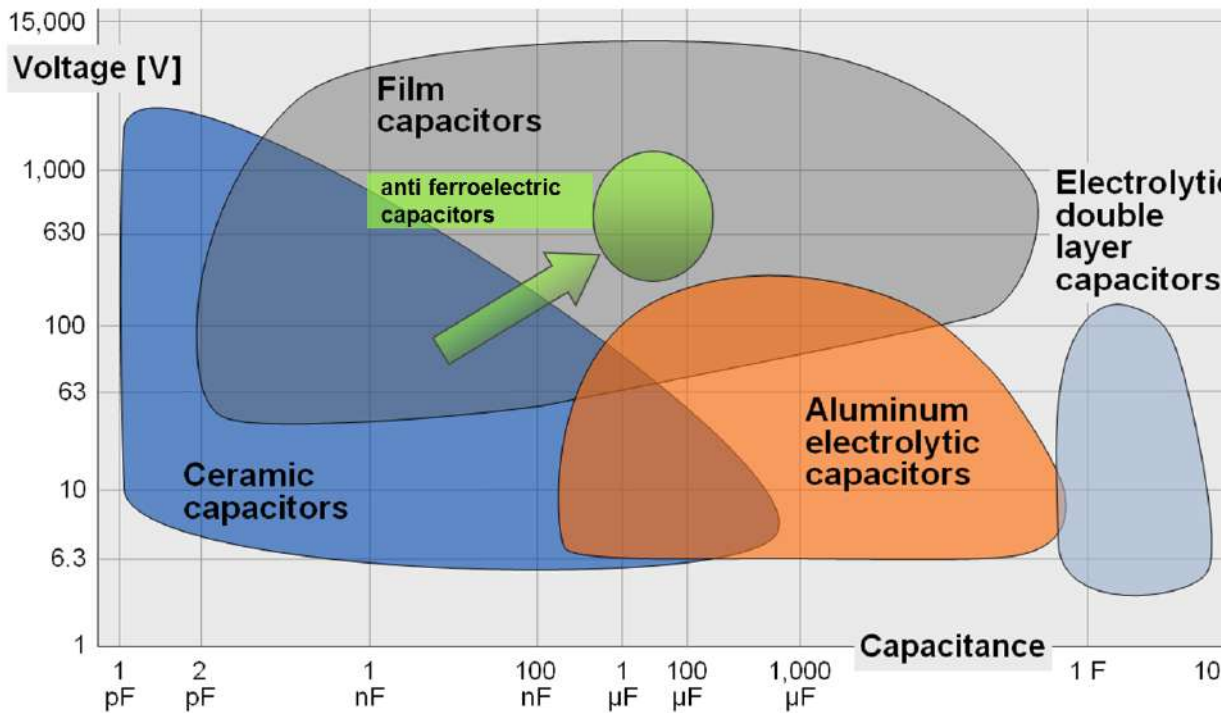

Characteristics as well as lifetime, reliability and failure modes need to be investigated separately. WInSiC4AP will focus on the interaction of SiC semiconductors with the capacitors in the different demonstrator projects on both electrical and thermal behaviour.

To keep up with the demands of SiC, capacitor technologies need to deliver higher efficiency, increased reliability and higher capacitance density. It is necessary to expand the area of existing technologies or optimize existing types of capacitors.

Anti-ferroelectric capacitors (CeraLink™) can answer the needs of SiC applications if a high power rating within a minimum space is necessary:

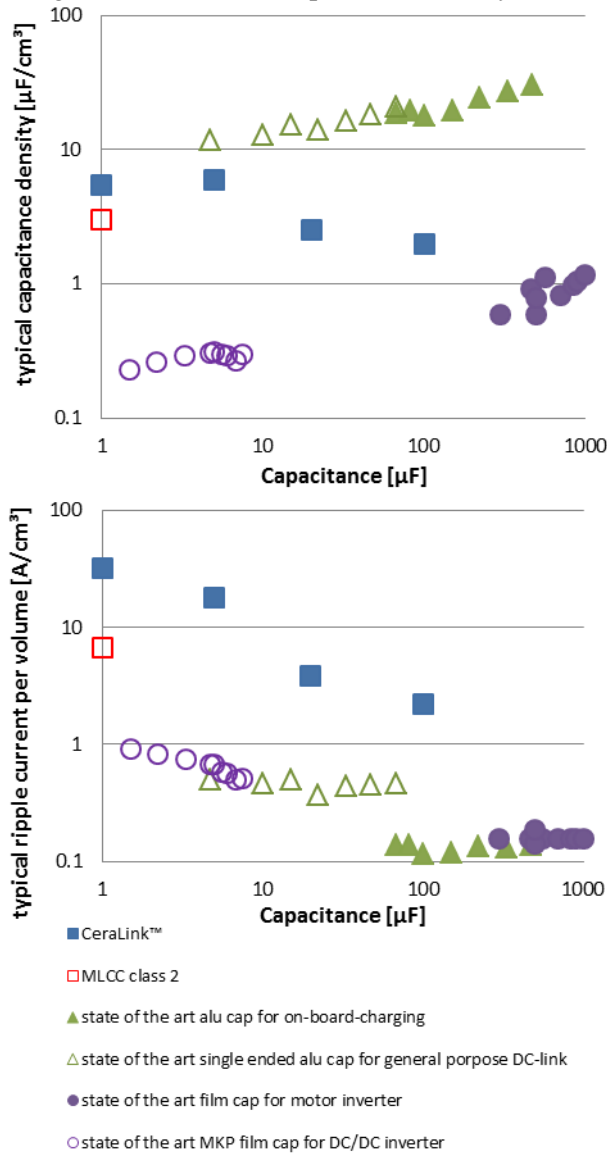

New process technologies and connection concepts like silver sintering will be developed to ensure high robustness against thermal cycles while maintaining good thermal and electrical conductivity. Due to the fact, that SiC semiconductors are able to work at temperatures up to 200°C and above, capacitors are faced with higher ambient temperatures. During the project, anti-ferroelectric capacitors will be developed which show a good thermal robustness on the one hand and show a high efficiency on the other hand.

Anti-ferroelectric capacitors offer high thermal robustness during operation. These capacitors will be optimized and adapted to support highest levels of efficiency and lowest inductances in combination with the semiconductors.

Power Inductors, Transformers and EMC components for the 5 demonstrator projects are developed and defined. For SiC based fast-switching systems EMC requirements are crucial. Du/dt proof components and high frequency packaging are to be developed. Especially high frequency ferrite materials will be assessed for use at the aimed temperatures and integration level.

Task 3a.1: FE/BE development and Building blocks for 1200V SiC device
 (ST-I leader, ST-I, UNIPRA, LUH, CNR, aPSI^{3D}, UNITOU, IMA)

Task 3a.1 Start month T6, End Month T30

Development and characterization of SiC wafers front and back metallization schemes as well as new interconnections materials and processes for die attachment and wire bonding to optimize the global electrical, thermo mechanical robustness and performances of building blocks for 1200V SiC device. Trench MOSFET technology will be developed to fabricate “state of art” 1200V SiC MOSFET with high current capabilities, minimum on losses and high dynamic performances. In particular an innovative trench MOSFET structure on Silicon Carbide able to withstand 1200V will be demonstrated with reduced elementary cell, recessed gate structure, thick oxide thickness on trench bottom and innovative shielding structure to minimize electric field in reverse bias on dielectric gate area. Current flow on vertical channel will be improved by special processes able to recover damage on trench walls.

Main building blocks to be developed are:

- trench etch process,
- gate formation with thick oxide on trench bottom,
- damage recovery of trench walls,
- MOSFET edge structure,
- new front side and back side metallization process to improve thermal performances

Dimension of trench spacing will be defined by simulation and multichip approach. The best trade-off between on losses (On resistance) and Breakdown Voltage will be studied. After BE process, fabricated devices will be characterized in static and dynamic conditions and best design will be used to layout the device of a specific die area according application request. Optimization of design after evaluation in application is also forecasted.

Target of the activity is to reach a $R_{on} \cdot Area$ lower than $3m\Omega \cdot cm^2$ and a $Q_g \cdot Area$ lower than $20nC \cdot cm^2$. These values represent the best value ever obtained in a 1.2kV MOSFET structure.

In this WP it will develop a prototype of components and whole electronic for the SiC actuator demonstrator.

As already mentioned, grinding the substrates is the only viable way to meliorate electrical and thermal performances. However, from a process point of view, the best solution seems to perform this task at the end of the device fabrication (Front-End) to limit any risk of wafer breakage associated with the mechanical fragility induced by reducing the substrate thickness. This raises the problem of the formation of the ohmic contact on the backside of the wafer. Indeed, up to now, Ohmic contact requires annealing at a temperature above $900^\circ C$ to obtain lowest possible specific contact resistance ($< 10^{-6} \Omega \cdot cm^2$). Such thermal budget can degrade the properties of wafer front-side technological milestones.

Partners will work on the backside metallization on grinding substrates aiming to obtain the lowest possible SCR value. To achieve such a contact requires:

- to find a suitable metallization to obtain an ohmic contact consecutively to a low temperature annealing (much lower than the classical values $> 900^\circ C$),
- to develop annealing techniques that just locally heat the wafer without reaching wafer front-side, such as laser treatment,
- to characterize the impact of the metallization and of the following annealing on wafer deformation, which is a crucial concern.

Classical studies of contacts using TEM, SEM, AFM and XRD will be provided. On an electrical point of view, SCR values will be extracted using the well-known TLM structures on a probe station. These characterizations will be performed in close collaboration with CNR.

Partners will simulate and to model properties of the building blocks for integration of SiC devices, will be used especially thermo-mechanical simulation to optimize reliability, thermo-electrical characterization.

Partners will perform an advanced characterization of new metallizations process on SiC wafer developed in collaboration with UNITOU and ST-I (either on n-type or p-type regions). Several complementary morphological, structural, electrical and optical techniques will be used (AFM, XRD, Raman, C-AFM,...). The electrical measurements will be performed also as a function of temperature to assess the fundamental parameters of the metal/semiconductor junction.

Also, in this task, the partners will perform the electrical characteristics of the 1200V SiC modules:

- Statistic measurements: I(V) temperature range -50°C up to 175°C, in forward and reverse mode, DC and pulse mode
- Dynamic switching
- C(V) characteristics up to 1200V

Task 3a.2 : FE/BE development and Building blocks for 1700V SiC device (ST-I leader, ST-I, UNIPRA, LUH, aPSI^{3D}, UNITOU)

Task 3a.2 Start month T6, End Month T30

Development and characterization of SiC wafers front and back metallization schemes as well as new interconnections materials and processes for die attachment and wire bonding to optimize the global electrical, thermo mechanical robustness and performances of building blocks for 1700V SiC device. 1700V SiC diode and MOSFET will be developed. Particular focus will be given to edge structure in order to optimize electric field distribution in edge device area minimizing crowding and improving edge robustness. Simulation activity will drive experimental choices and different configuration of field plate extension and ring lateral dimension will be considered. Optimum epitaxial specification will be also defined by DOE (Design of Experiment) approach.

1700V SiC diode are based on JBS (Junction Barrier Schottky) structure where ohmic contacts on p+ stripes and Schottky contacts on n-type SiC epitaxial layer are repeated side by side on the whole device surface. The dimension and spacing of p+ stripes will be optimized by multichip approach in order to study the best trade-off between on losses (forward voltage drop at nominal current) and leakage current in reverse bias at 1.7kV.

1700V SiC MOSFET will be based on a planar structure. Dimension of elementary cell components will be defined by simulation and multichip approach. The best trade-off between on losses (On resistance) and leakage current in reverse bias at 1.7kV will be studied.

After BE process, fabricated devices will be characterized in static and dynamic conditions and best design will be used to layout the device of a specific die area according application request. Optimization of design after evaluation in application is also forecasted.

Target of the activity is to reach a $R_{on} \cdot Area$ lower than 10mOhm*cm² and a $Q_g \cdot Area$ lower than 100nC*cm². These values represent state of art values in a 1.7kV MOSFET.

In this task, the partners will perform the electrical characteristics of the 1700V SiC modules:

- Statistic measurements: I(V) temperature range -50°C up to 175°C, in forward and reverse mode, DC and pulse mode
- Dynamic switching
- C(V) characteristics up to 1700V

**Task 3a.5: Gate drive transformers
(WÜRTH Leader, ST-I, UNIPRA, LUH, WÜRTH)
Task 3a.5 Start month T6, End Month T28**

Discrete gate drive transformers, optimized for SiC devices, will be developed and characterized as well as Gate drive transformers in magnetics on silicon technology.

Partners will simulate and model properties of the device blocks (Gate drive transformers), the core of the work will focused on the thermo-mechanical simulation to optimize reliability.

Activity of ST-I is focused on building FE and BE for 1200V and 1700V SiC MOSFET to use for modules and demonstrators targeting 200°C with tentative to reach 250°C. ST-I is leader of WP3a and responsible for following tasks:

- **3a.1** FE/BE development and Building blocks for 1200V SiC device
- **3a.2** FE/BE development and Building blocks for 1700V SiC device

Within WP 3a, aPSI^{3D} will package ST dice in order to leverage their whole capability in terms of power density, low switching losses at high frequency. Eventually, users can demonstrator highly differentiated converters.

Inputs : dice, module requirements

Output: Power modules.

WÜRTH will develop discrete gate drive transformer prototypes for each demonstrator according to the target specification defined during WP2a. During the electrical and mechanical design WÜRTH will adapt an existing discrete transformer technology to the specific needs of SiC power transistor applications.

After manufacturing the prototypes will be characterized and resulting parameters will be compared with the target specifications. Any misalignment with target specification or change in target specification will require a redesign and repetition of the characterization.

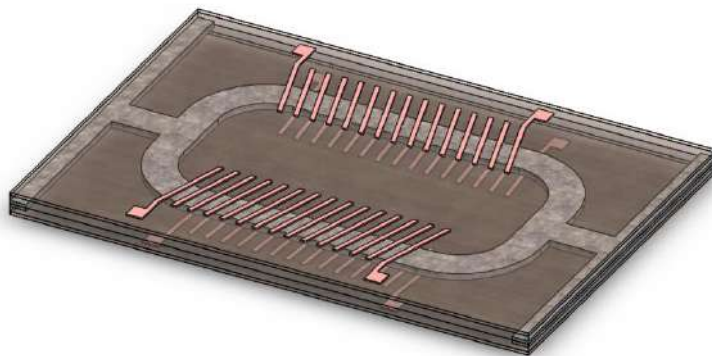

Schematic transformer layout without through hole connection

Within the collaboration with LUH, WÜRTH will be in charge of the magnetic component design and FEM-based simulations as well as for the electrical characterization of the prototypes. LUH and WÜRTH will investigate together new fabrication technology to deliver innovative closed magnetic core transformers with a high electrical efficiency above 80 % in comparison to micro-transformer by the same package volume which can be applied to SiC gate drive circuits. Transformers based on this technology will have very low profiles compared to discrete wire wounded transformers. Therefore the elimination of ineffective materials like the substrate by using silicon as wafer is plan. Furthermore the elimination of interface layer a like seed layers for electroplating steps will perform. To full fill the needed electrical performance -conduction and insulation- polyimide foils with pre-laminated thick copper layer will use. A new fabrication

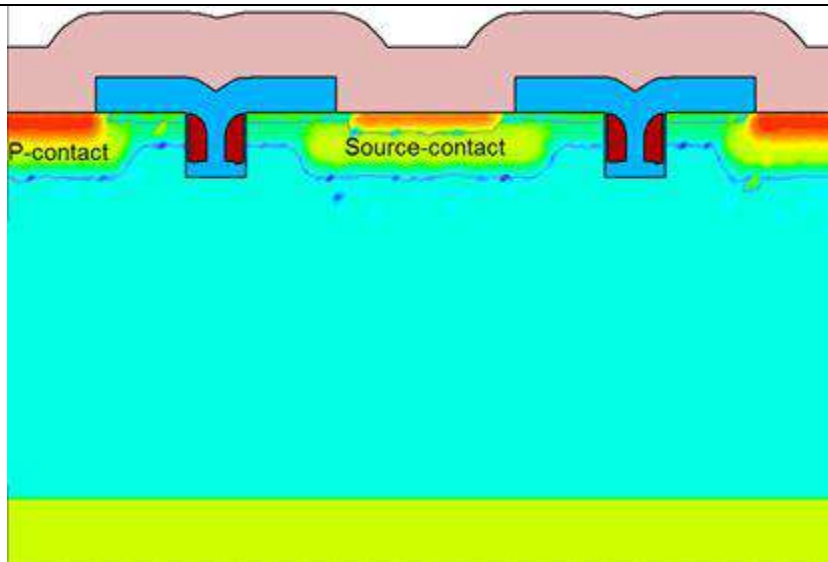

Main building blocks to be developed are:

- trench etch process,
- gate formation with thick oxide on trench bottom,
- damage recovery of trench walls,
- MOSFET edge structure,
- new front side and back side metallization process to improve thermal performances

Dimension of trench spacing will be defined by simulation and multichip approach. The best trade-off between on losses (On resistance) and Breakdown Voltage will be studied. After BE, fabricated devices will be characterized in static and dynamic conditions and best design will be used to layout the device of a specific die area according application request. Optimization of design after evaluation in application is also forecasted.

Target of the activity is to reach a $R_{on} \cdot Area$ lower than $2.5 m\Omega \cdot cm^2$ and a $Q_g \cdot Area$ lower than $20 nC \cdot cm^2$. These values represent the best value ever obtained in a 650V MOSFET structure.

High current capability request will be handled by putting in parallel two or more MOSFETs in a single package or a module according end user specification.

The possibility to employ new dielectric solutions for MOS-based devices will be explored. Different oxides stacks and post-growth thermal annealing will be considered, including Atomic Layer Deposition (ALD) techniques, and characterized under the morphological and structural point of view. High-k dielectrics by ALD can guarantee an optimal redistribution of the electric field near the interface and, hence, an optimization of the device R_{on} and oxide reliability. The developed process will be characterized in electrical test patterns in WP5b.

Task 3b.2: Process integration for innovative Power Module, development and prototyping (ST-I leader, ST-I, UNIME, ZODAERO, SAT)

Task 3b.2 Start month T6, End Month T28

For the Packaging technologies, WInSiC4AP will focus on introducing a breakthrough in the robustness of the full assembly solution at high temperature in order to provide the **needed breakthrough** to fill the gap between current state of the art and the very high demanding specifications required for avionics, automotive, transport and defense:

- Needed to fully exploit the **high temperature** operation capability of SiC
- Needed **high reliability** for the very critical targeted applications needing a long life time,

full safety and/or functioning in a harsh environment and at higher frequencies than today

- Needed to develop systems in SiC with higher power density and efficiency than currently-available solutions, **eliminating water cooling, reducing global system weight**
- Brand **new technology solutions** to fulfill above expectations

The ultimate goal will be to break new records in reliability:

- more than 5 times the state of the art, and also in performance at high temperature;
- ability to work at 200°C or above.

The package reliability and robustness enhancement will be made through the use in the Power Module of new or advanced materials, processes and designs.

Advanced developments, complementary to 3a.1, 3a.2, 3b.1, on materials will be done in this tasks. In particular on **gel potting, molding compound for high temperature environment** (beyond 225°C), and on new substrates like diamond, or very light ones based on Al material .

Additionally , investigations will be carried out on **new SiC dice singulation** processes as ultrasonic sawing or laser sawing since dice chipping produced during sawing is a potential **reliability detractor** and such defects should be reduced or eliminated.

Two Power Modules, integrating selected process and material improvements or breakthroughs coming from previous WP3 tasks, will be developed and realized to support the 2 Product Demonstrators for Avionics and Automotive applications.

3b.2.1 Materials for high temperature environment

In terms of materials will be considered **innovative substrates, potting materials, gels, resins able to support and guarantee, with a high reliability level, functioning at temperature higher than 200 degree). New green molding compounds, epoxy and non epoxy based, for Molded Module, with special compound structure for low leakage will be used.** Adhesion and thermal properties of such molding compounds formulated with organic phosphorus based flame retardant and polyaromatic organic matrices will be studied through a well consolidated laboratory procedure. Molding compound for Hi temperature will be also used for special TO247 power discrete with SiC able to guarantee till 250 °C, will be used in the WInSiC4AP project for SiC prototypes characterization (thermal, electrical, reliability, robustness in the application).

3b.2.2 Ultrasonic welding process

Advanced Processes will be developed or improved for advanced Power Modules fabrication.

Ultrasonic process to weld pins directly in the substrate with high quality ensuring low contact resistance, high current capability, thermally and electrically stable joints, long life time;

3b.2.2 Advanced Sawing of SiC wafers

Current state of the art diamond blade sawing has a very low productivity due to SiC material hardness and is generating some chipping.

An advanced New **Ultrasonic-wave sawing process using** special equipment and tooling will be developed. Since transmission of ultrasonic-wave oscillation to the blade improves water circulation promoting the self-sharpening of the blade, the feed speed could be strongly increased as well as global sawing process quality. The target is to increase the productivity by a factor of at least 3-4 times.

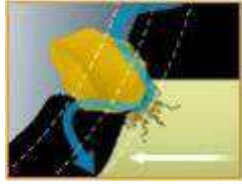

Dicing using ultrasonic waves



Conventional dicing

The other important axe which will be investigated is the SiC laser sawing of which the **laser + plasma dicing approach**. Expected benefits are the quality of sawing vs chipping, side walls, scribe line reduction. This would represent a breakthrough for this critical process step for SiC. The productivity and global cost of ownership will be also evaluated and taken into account.

3b.2.3 Innovative lead free Die Attach implementation

Innovative and lead free Die Attach dedicated to SiC to improve Electrical performance (RDSon reduced up to 20%, Avalanche and Short Circuit resistance increased by a factor of 5), Thermal Performances Rth reduced by 30%), Quality & Reliability (Life time in Power Cycling multiplied by 10 times). Zero voids in the die attach joint shall be targeted.

3b.2.4 Advanced Interconnection implementation

Advanced Interconnection / Wirebond less options to reduce the interconnection resistance and increase the Current capability as well as to improve the Reliability level. The project is intending to overcome Al interconnection limitations by investigation of: Clip made by raw or plated (Ag; Au; Pd;...), Wires Al/Cu (~4-5 times of TC improvement) or Heavy Cu bonding on Cu front metal focusing on tailored and customized front side, to achieve an thermos electrical management system and “state of the art” electrical performances improving drastically the reliability performances and the load carrying capability.

3b.2.5 Innovative Power Modules Development for Avionics Demonstrators

The Power Modules will be designed from the specifications coming from previous WP with the target to fulfil the mission profile of the application and additionally to make a breakthrough in thermal dissipation, reliability and weight.

They will integrate some incremental innovation developed in WInSiC4AP specifically for SiC in WP3.

This integration of advanced materials and processes will be decided in regard of the achieved results and according to the project planning with the consortium members in charge of realizing the Product demonstrators for testing the innovative architectures of the different applications.

The processes parameters will have to be set for the selected materials and process steps in the previous tasks.

3b.2.6 Integration of radical innovation solutions

In order to complement the evaluation of the radical innovation solutions developed in the section 3.2 section, they will be integrated in Power Modules for functional characterization, reliability evaluation, benefits verification, ST-I will also work to integrate in the power module prototypes the main bricks will be developed by partners:

Dual Side Cooling (using double side approach like aPSI^{3D}), with a wire-bondless solution to drastically reduce the parasitic contributions (stray inductance reduction by 50%), improve electrical performances such as overvoltage or losses under high current switching, as well as

thermal performances (more than 50% heat extracted for a given junction temperature), improving compactness, cost, weight and reducing the need for an oversizing of die voltage rating.

UNIME will support the characterization activity of SiC devices with nanoscale resolution analyses, like Scanning Probe Microscopy and Spectroscopy (AFM, NSOM, Nanofluorescence, TERS). The skillful application of these advanced characterization methods will provide access to valuable information both for processes optimization and for devices simulations.

SAT's contribution will consist of the design and construction of a pilot line to support the prototyping phase expected in the development of the Power Module. In particular, the pilot line will be arranged and equipped to support fully-automated wet processes (etching, cleaning) planned for the steps of prototypes fabrication, also providing an integrated SRD device for rinse & drying, and a SSAT (SiC Spray Acid Tools) station, planned to develop SiC processes of etching, cleaning and dry.

ZODAERO will support power module definition and development.

		YEAR 1												YEAR 2												YEAR 3													
		1	2	3	4	5	6	7	8	9	10	11	12	13	14	15	16	17	18	19	20	21	22	23	24	25	26	27	28	29	30	31	32	33	34	35	36		
WP3b	FE/BE Lov Voltage high current technology bricks development & characterization (650V @400A SiC)																																						
3b.1	FE/BE development and Building blocks for 650V SiC devices																																						
3b.2	Process integration for innovative Power Module, development and prototyping																																						

WP4 Open platform and Design Methodologies

Objectives

Advance beyond State-of-the-Art in discrete component modelling and simulation. Design techniques and methodologies to develop in order to secure robustness and efficiency required by next-generation devices: ambition is to cover the abstraction level from technology up to the system. Provide an open platform helping to expedite the design of new applications in SiC starting from reference model hardware.

Description of work

The reliability and demonstrators will drive the identifications and development of an innovative WInSiC4AP approach following the below tasks:

Task 4.1 Design and application advanced methodologies (ST-I Leader, ST-I, VSCM, UNIPRA)

Task 4.1 Start month T9, End Month T24

The task has the aim to enhance the existing abstraction and modelling capabilities for the Discrete devices in order to improve the design optimization on one side (post processing) and to fill the existing gap between the PCB specification and the components design (forward design). The activities will be articulated in three steps:

1) Analysis of the end user (ST designer , ST customer or WInSiC4AP partner) requirements and of the gap between the existing methodologies. The work shall specify the WInSiC4AP industrial design methodologies developments and the target means of verification of the success for the tools and the methods to be developed.

2) Development of the specified tools, industrial design procedures and methodologies automation.

3) Validation and demonstration of the WInSiC4AP design solutions

The three steps will be developed for the three relevant aspects into the WInSiC4AP identified scopes: Discrete components modelling/validation/simulation design techniques and methodologies (ST-I, VSCM, UNIPRA)

An agile modeling and system-level simulation methodology for correlated functional and thermal behavior will be devised, based on state-of-the-art description languages such as Verilog A and System C-AMS. Such developments are necessary to avoid design failures and consequent costly design reiterations, safeguarding the time to market and enabling the design space exploration.

The End user (VSCM) will be part of the activity with the added value to enhance the semiconductor manufacturer competitiveness by ensuring better customer/provider mutual understanding.

-The high frequency model of the PCB will be developed in order to evaluate EMI issues, moreover, it will allow the possibility to test in simulation different solutions to comply EMC standards.

Task 4.2 From Specific Requirements to Open Platform

(ST-I Leader, ST-I, VSCM, UNIPRA)

Task 4.2 Start month T9, End Month T28

The task will start from consolidated view of specifications as output of WP2a and WP2b and a Open-Access “standard” platform will be abstracted through the e-design module to be used as a reference design to starts new design particularly RTOs Partners in the different countries will work as a “knowledge center” to synthetize the Open Platform Reference Designs, ST Italy will integrate it in the e-design module and results will be part of the dissemination activities to address the community of SMEs and Start UPs.

The knowledge of the real operative temperature and the mechanical displacement play a key role in the evaluation of the reliability and in the estimation of the expected lifetime. In this frame, it will be performed the high speed thermal mapping to provide real information on the temperature distribution on the devices surface during cycling current pulses. For a better qualification of the devices performances, a thermal induced strain direct measurement approach will be performed. The measurement is based on the direct measurement of the strain by means of an interferometer laser setup. The method will give information useful for a more real estimation of the lifetime for instance by directly applying the reliability model such as the Coffin Manson law. The thermal and the strain mapping information will be used to feedback to WP3 and to improve the device design.

A Open-Access “standard” platform will be abstracted through the e-design module to be used as a reference design to starts new design particularly RTOs Partners in the different countries will work as a “knowledge center” to synthetize the Open Platform Reference Designs, ST Italy will integrate it in the e-design module and results will be part of the dissemination activities to address the community of SMEs and Start UPs.

Sensors for Intelligent Power Module (IPM):

To develop an IPM, it will be integrated a current sensor and a temperature sensor. There are two possibilities: monolithically (sensor in the Silicon Carbide die) or sensor in the module.



		YEAR 1								YEAR 2								YEAR 3																			
		1	2	3	4	5	6	7	8	9	10	11	12	13	14	15	16	17	18	19	20	21	22	23	24	25	26	27	28	29	30	31	32	33	34	35	36
WP4	Open platform and Design Methodologies																																				
4.1	Design and application advanced methodologies																																				
4.2	From Specific Requirements to Open Platform																																				

WP5a Reliability 1200-1700V SiC

Objectives

Avionics and HEV reliability analysis.
 In Workpackage 5a possible failure modes of the defined technology bricks are evaluated and the fulfilment of lifetime requirements is assessed.

Description of work

Reliability will be assessed particularly addressing the relevant standardization committees in the Avionics and HEV fields. Different analysis will be carried on by exploiting Avionics and HEV partners’ competencies and sharing and integration of different practices will be done to explore opportunities for defining a standard approach for SiC.

Fulfilment of lifetime requirements for passive components is assessed for each demonstrator.

Task 5a.1: Device characterization and parasitic effects evaluation (ST-I leader, ST-I, VSCM, IUNET, UNIPRA, aPSI^{3D})
Task 5a.1 Start month T10, End month T33

The aim of this task is to accurately identify the device performance and the main limitation and/or parasitic effect of active and passive devices in order to verify if the specifications required for the specific application of this project are achieved.

Test structure design and testing methodologies will be defined in the initial part of this activity. Parasitic effects like gate leakage current, threshold voltage instabilities, drain leakage current, charge trapping leading to current collapse and RDSON transients, will be studied in detail in order obtain a detailed characterization of all these problems. Thermal characterization, heat transfer and novel techniques will be employed with the aim of fully understanding the device operation in the operating conditions. Electroluminescence and noise measurements characterization will be employed with the aim of carefully identifying gate leakage issues. The basic physical mechanisms leading to breakdown will be deeply analyzed using DC and pulsed electrical measurements performed at different ambient temperatures as a function of epitaxy, process and layout choices. OFF-state as well as ON-state breakdown will be studied in three terminal configurations, and correlated with the simulations. Electroluminescence will also be employed in order to identify uniformity and specific localized breakdown sites within the devices active area. The aim of this activity will be the identification of the device Safe Operating Area (SOA). The device simulation of power SiC devices will also be carried out.

Models of high-field carrier transport and impact-ionization will be evaluated and developed. Furthermore, TCAD simulators will be employed in order to study the trapping phenomena and reliability issues in power SiC devices with the aim of a predictive approach for the development of robust and reliable devices. Thermal and self-heating effects will also be simulated and linked to the

experimental data. TCAD methodologies that allow fast and robust simulations will be developed and implemented.

Advanced characterization techniques will be employed to help the optimization the device: **Optical Beam Induced Current (OBIC)** and **Electroluminescence (EL)**. The OBIC technique will be of great help to the investigation of the edge termination issue, while the EL will be employed to help the realization of devices with low on-resistance of the device through layout design improvements.

Optical Beam Induced Current (OBIC) Characterization:

To obtain an optimized power device, one of the main works is the edge termination. ST-I has optimized several solutions, which have been tested electrically but their physical characteristics are only accessible by OBIC.

Moreover, comparison can be made with simulations to confirm or improve the physical or design model. As the secondary passivation is occlusive to the laser beam, the device must not present passivation or gel prior to characterization.

The characterization will be performed for the MOSFET and Schottky diodes.

Electroluminescence (EL) Characterization:

IUNET is in charge of the development of a set-up to characterize SiC MOSFET and Schottky diodes using the Electroluminescence method. For that, a specific camera (CCD) will be employed. The goal is to observe the homogeneity of conduction in the device.

- SiC MOSFET Design: regarding the design of the device, this method allows to access the efficiency of the layout or technology homogeneity of the MOSFET. This feedback allows to further minimize the on-resistance of the device through layout design improvements.
- SiC DIODE Design: regarding the Schottky diode, in SiC technology, the diodes have several P⁺ rings (like a Junction Barrier Schottky diode, JBS). These rings can increase the surge current capability and decrease the leakage current in reverse mode. Their efficiency strongly depends on their position and design in the layout. Electrical characteristics provide their efficiency at the device level and simulation only gives theoretical results. The EL characterization allows assessing their local efficiency at the semiconductor level. The goal of the EL characterization is to optimize the design of the P⁺ rings in order to improve the surge current capability and reliability of the diode.

Test Report will be provided iteratively to ST-I in order to integrate the feedback on the various design cycles.

UNIPRA will take a part on the device characterization and parasitic effects evaluation, giving also indications on the optimization of the structures using the numerical simulations of the charge transport and thermo-mechanical modeling.

The role of each partner in Task 5a.1 is reported in the Table below:

Task 5a.1	ST-I	VSCM	IUNET	UNIPRA	APSI
Test devices and characterization definition	X	X	X		X
Charge trapping and parasitic effects			X	X	
Breakdown characterization			X		
Thermal characterization			X	X	

Task 5a.2: Reliability investigation of devices

(ST-I Leader, ST-I, VSCM, IUNET, UNIPRA, ZODAERO, aPSI^{3D})

Task 5a.2 Start month T16, End month T33

In this task the evaluation of the **short-term** and **long-term** stability of the electrical and physical characteristics of active power devices (SiC MOSFETs and Diodes) will be carried out. The definition of the lifetime tests, the failure criteria and the test conditions will be defined at the initial stage of this task.

The main goal of this activity will be the identification of SiC power device specific parameter drifts and failure modes and mechanisms in power switching SiC MOSFETs and their correlation with the different device substrates and gate topologies.

Since we are treating new generation power devices, we must act in line with the agreed concept that the whole device must be qualified, taking into account all the possible interactions of the different parts of which it is made. This approach implies an accurate phase of reliability and analysis that moves in parallel with the development of the different process solutions, in order to give prompt feedback to correct or choose the best one. The best process solutions, both from front-side and back-side point of view, must be consolidated through reliability tests. The reliability characterization of new power devices will be carried out, first of all, by standard fatigue trials; such kind of characterization will be addressed both to prototypes and pilot lots during devices development and then also to final production devices and modules in typical application when the product is in the final step of evaluation.

The stress induced degradation will be evaluated by monitoring the gate leakage increase during time dependent dielectric breakdown (TDDB) stress and the threshold voltage drift during bias temperature instability (BTI) stress and by high speed thermal and mechanical stress mapping of new and aged devices. The knowledge of the real operative temperature and the mechanical displacement will allow the implementation of reliability models aiming to assess the device lifetime.

Diodes will be characterized by applying stress in the OFF-state as well as ON state. The impact of both types of stress on the main figures of merit (e.g. the turn-on voltage, the forward voltage and the ON-resistance) will be investigated at different voltages and temperatures in order to identify the physical properties of the defects responsible for the device degradation.

The Electro Static Discharge (ESD) and Unclamped Inductive Switching (UIS) robustness and the impact of radiation exposure and the effects to the Single Event Effects (SEE) will also be investigated using main electrical parameter drift approach.

The canonical stresses that will be applied on test-chip subassemblies and the power modules are:

- HTB (High Temperature Bias) and OLT (Operative Life Test)
- HTFB (High Temperature Forward Bias) or Gate Stress
- HTS (High Temperature Storage)
- Thermal Fatigue
- THB (Temperature Humidity Bias)
- Pressure Pot
- Thermal Cycles

A more specific test will also be applied to the developed devices: Long Term High Temperature Resistive Load Switching. A long term switching stress on multiple SiC MOSFETs at high temperature (250°C, and potentially more) on different die sizes will be performed. In a first stage, devices will be stressed until complete failure to obtain their lifetime at 3 temperatures under similar electrical conditions. In a second stage, devices will be stressed half of their lifetime and electroluminescence characterization will be performed. Unstressed devices will also be characterized to provide a comparison between stressed and unstressed devices.

Thermo-mechanical simulations will be performed in order to study and better understand failure phenomena. Modern approach to lifetime evaluation consists of replacing the simple engineering estimation with complex FEM simulation models including aspects of the thermo-mechanical behaviour derived from its electrical and environmental operation conditions. For the reason that reliability and lifetime of SiC active power devices is one of the major criteria, numerical modelling and optimization of thermomechanical stresses are key issues during new component development. Detailed examination of the physical phenomena leading to the discovery of failure mechanisms will be carried out.

ZODAERO, VSCM and aPSI^{3D} will support the reliability investigation of devices by contributing to test specification.

The role of each partner in Task 5a.2 is reported in the Table below:

Task 5a.2	ST-I	VSCM	IUNET	UNIPRA	APSI	ZODAERO
Short-term on-wafer reliability investigation	X		X			X
Medium-term reliability investigation on packaged devices	X	X	X			X
Unclamped Inductive Switching robustness	X		X			
Long-term high temperature Resistive Load Switching	X	X				X
Thermomechanical simulations	X			X		
Degradation mechanisms investigation	X		X		X	

Task 5a.3: Failure Analysis and physical modelling
(IUNET leader, ST-I, VSCM, IUNET, UNIPRA, CNR, ZODAERO, aPSI^{3D})
Task 5a.3 Start month 10, End month 33

The adoption of advanced failure analyses like Spectrally-Resolved Cathodoluminescence (SCL) in scanning electron microscope (SEM), micro-photoluminescence (μ PL), UV and VIS micro-Raman spectroscopy (μ RS), X-ray inspection system for inspecting high-quality assemblies and interconnections in semiconductors, and FIB/TEM investigation will allow an in-depth understanding of the degradation physics. The severity of the different device instabilities will be assessed for each targeted application in order to give consolidated recommendations for further device and processes optimization.

Canonical fault isolation technique like back side OBIRCH (Optical Beam Induced Resistance Change) and Electroluminescence (EL) will be also be adopted. High speed thermal and mechanical stress mapping of new and aged devices will be employed to improve and validate the processes optimization.

The device simulation of power SiC devices still presents several challenges with respect to the device operation at high electric field/temperature, modelling of trapping and de-trapping phenomena and to the modelling of the degradation mechanisms. IUNET will evaluate and develop models for the analysis of hot-carrier degradation. Furthermore, TCAD simulations will be employed in order to study the long-term SOA in with the aim of a predictive approach for the development of robust and reliable devices.

CNR will be in charge of electro-thermal simulations of MOSFET devices in order to elucidate the effects of hotspots on the device performance. Self-consistency between heat generation and electrical parameters of the materials will be considered in the modelling approach.

Based on the identification of the failure modes and degradation mechanisms investigated in the first phase of the task, a suitable circuit topology will be devised by so to better assess the power SiC device performance and robustness. Finally, a test circuit capable of highlight the device performance in real operating conditions (hard-switching and soft-switching cases) will be developed.

ZODAERO, VSCM and aPSI^{3D} will support the characterization activity of SiC devices in the definition of operating conditions.

The role of each partner in Task 5a.3 is reported in the Table below:

The objectives described above will be reached by organizing the activities of the WP5 in 4 tasks that will generate report for each design cycle to allow optimization of the components (SiC Mosfet, SiC Diodes, Transformers, Inductances and Capacitors) and integration processes (metallization, interconnections).

CNR will be involved in the characterization of the elementary building blocks for MOSFETs devices. In particular, a characterization at a wafer level of test structures (capacitors, diodes and lateral MOSFETs), and of their fundamental building blocks (SiC/dielectric interfaces, SiC/metal interfaces..) will be carried out using both electrical analyses based on I-V and C-V measurements as a function of the frequency, of the temperature and time-resolved, in order to get deeper understanding in the charge trapping phenomena that directly impact the threshold voltage V_{th} stability and Fowler Nordheim anomalies. Besides SiO₂ layers (deposited or thermal oxides, subjected to different annealing processes) also the new high-k dielectrics developed in WP3b will be integrated in MOS devices and characterized.

SAT's contribution will consist of the design and construction of a station, equipped with the required devices, to support the testing operations provided for performance and reliability assessment, and validation of the prototypes, as necessitated by the scheduled task in question.

**Task 5b.2: Reliability investigation of devices
(UNIME leader, ST-I, UNIME, CNR, SAT)**

Task 5b.2 Start month T7, End Month T30

Reliability for the power devices industries is a relevant feature having the same importance of other characteristics like performances, service, quality and compactness. In the state of the art the reliability models are widely based on numerical simulations with finite element methods that provide the required mechanical strain. The main approaches to modeling and predicting the fatigue are based on empirical characterization of the failure rate through accelerated tests, the identification of dominant aging mechanism and the application of a predicting model requiring a parameter that represents the exerted stress. The large bandgap of SiC results in a much higher operating temperature and higher radiation hardness. The high thermal conductivity for SiC (4.9 C/W) allows dissipated heat to be more readily extracted from the device. These special features of the material need the models to be adjusted and/or re-written to take into account with special care the effects of the cyclic repetition of the high temperature induced mechanical load on the source metallization. In this frame, the knowledge of the real operative temperature and the mechanical displacement play a key role in the evaluation of the reliability and in the estimation of the expected lifetime. Unime will perform the high speed thermal mapping to provide real information on the temperature distribution on the devices surface during cycling current pulses. For a better qualification of the devices performances, a thermal induced strain direct measurement approach will be performed. The measurement will be based on the direct measurement of the strain by means of an interferometer laser setup. The method will give information useful for a more real estimation of the lifetime for instance by directly applying the reliability model such as the Coffin Manson law. The thermal and the strain mapping information will be used to feedback to WP3 and to improve the device design.

Different methodologies of electrical characterization of MOS-based devices will be compared by CNR in order to define a standard procedure to correctly evaluate the V_{th} instability in MOSFETs devices subjected to severe electrical stress.

SAT's contribution will consist of the design and construction of a station, equipped with the required devices, to support the testing operations provided for performance and reliability assessment, and validation of the prototypes, as necessitated by the scheduled task in question.

**Task 5b.3: Failure Analysis and physical modelling
(ST-I leader, ST-I, UNIME, CNR, SAT)**

Task 5b.3 Start month T13, End Month T32

The adoption of advanced failure analyses will allow an in-depth understanding of the degradation physics.

The mechanism of device failure (in terms of electrical active interface-defects, ion-implantation defects, “counter doped” interfacial regions, etc.) will be investigated at CNR with optical techniques (microRaman, PL) on the implanted regions and nanoscale characterizations (SCM, SSRM, C-AFM, TEM, etc..) on cross sectional samples.

Theoretical calculations of the structural and electrical properties of the SiO₂/SiC systems will be carried out in order to better identify the microscopic nature of the near interface traps (NITs) responsible for V_{th} instabilities and anomalous electrical behaviour.

SAT's contribution will consist of the design and construction of a station, equipped with the required devices, to support the testing operations provided for performance and reliability assessment, and validation of the prototypes, as necessitated by the scheduled task in question.

The developments will be carried out by the ST EDA and silicon designers with the scientific collaboration of UNIME.

-It will studied EMC and high switching frequency oriented design

-It will study the high frequency behavior of the PCB in order to extrapolate a model useful to be used as a brick of the whole system.

Task 5b.4: Reliability Assessment on state of art and gaps vs. WInSiC4AP application scope (ST-I leader, ST-I, UNIME, SAT)

Task 5b.4 Start month T15, End Month T32

Reliability is characterized at each step and particularly new novel approach will be developed to address it in the design phase from application up to the Silicon Carbide structure. Silicon Carbide (SiC) MOSFETs are the latest devices introduced in the power electronic market in an effort to fulfil the demand of even more compact and efficient power devices. A full comparison is here proposed among performance of state of the art Si devices (MOSFETs and IGBTs) and SiC MOSFETs for automotive applications. Such a comparison will include commonly regarded static, dynamic and driving features, as well as, long term device reliability issues. Specifically, a detailed investigation about the long term parametric stability of Silicon Carbide Power MOSFET devices for automotive applications will be accomplished, based on endurance tests and mathematical models. As standard endurance tests are not suitable for SiC MOSFETs, which are designed to work at temperatures well beyond those of Si devices, a major effort will be devoted to the definition of a specific set of high temperature endurance tests (static, switching mode, avalanche, etc.). Using data obtained from thermal and mechanical stress measurements, we will get some scalable mathematical models useful to be applied to devices with different geometric parameters. These models will be used in task 2.a for the predictive diagnosis of lifetime. Finally, the effects of different packages and molding compounds on the reliability of SiC MOSFETs will be taken in consideration.

Partner contribution:

The knowledge of the real operative temperature and the mechanical displacement play a key role in the evaluation of the reliability and in the estimation of the expected lifetime. In this frame, UNIME will perform the high speed thermal mapping to provide real information on the temperature distribution on the devices surface during cycling current pulses. For a better qualification of the devices performances, a thermal induced strain direct measurement approach will be performed. The measurement is based on the direct measurement of the strain by means of an interferometer laser setup. The method will give information useful for a more real estimation of the lifetime for instance by directly applying the reliability model such as the Coffin Manson law. The thermal and the strain mapping information will be used to feedback to WP3 and to improve the device design.

First Prototype design and realization (NEXTER - M36)

The main objective of the project is to obtain an IPS-AA Demonstrator with a maturity of TRL4 (Prototype). This prototype will integrate a power module and a control board.

- The IPS power module will include:
 - The power switches,
 - sensors (I,T°C),
 - gate drivers with insulated power supply
 - Reflex functions (analog electronics).
- The control board should be the same as that used on the mockup

Specifications V2 for the integrated IPS will be consolidated between NE and ST-I and technical feasibility will be accomplished for gate driver integration (M24).

According to the frozen design, ST Italy will provide an more integrated IPS module that supplied for the mockup model (M36).

WÜRTH will support the Task 6a.1 application owner during the design-in activity of the gate-drive transformer, to make sure the component is working properly under all application conditions.

Task 6a.2 Inverter for Avionics

(ZODAERO Leader, ST-I, NEXTER, ZODAERO, APOJEE, aPSI^{3D}, WÜRTH, ED)

Task 6a.2 Start month T3, End Month T36

Within this work package ZODAERO will develop a 45kW multirole power converter.

Two converter models will be realized. The second one will be the more mature of both and will be tested according to ZODAERO TRL3 scale criteria.

Activities will be centered around three main activities:

- Development & manufacturing of two versions of demonstrator
- Modelling and testing of control laws embedded within the demonstrator
- Development of test benches

The objectives of “Development & manufacturing” sub-work package are to:

- Define product internal architecture based on converter specification
- Work on first converter model preliminary design:
 - Definition of interfaces, main functions, HW and SW architectures, physical characteristics and estimation of performances
 - Definition of major passive and active sub-components specifications
 - If needed manufacturing of a first converter mock-up for de-risking the converter development activity
- Work on first converter model detailed design: freezing of interfaces, detailed design: internal HW & SW functions, active and passive power components, mechanical assembly, thermal and mechanical simulations, etc.
- Manufacturing of a first converter model. As part of WP 3.b, ST-I will manufacture, test and deliver the Power modules. WÜRTH will provide the passive components developed according to previous agreed specifications
- Validate first converter model behavior through debugging, functional tests.
- Work on second converter model detailed design:
 - Freezing of interfaces, detailed design: internal HW & SW functions, active and passive power components, mechanical assembly, thermal and mechanical simulations, etc.
 - Update of major passive and active sub-components definition
- Manufacturing of a second converter model with modified major components fulfilling expectations in terms of functionalities and interfaces. As part of WP 3.b, ST-I will

manufacture, test and deliver a second version of the Power modules. WÜRTH will provide the passive components with an updated definition.

- Validate first converter model behavior through debugging, functional and TRL3 tests.

The objectives of “Modelling and control development” sub-work package are to:

- Participate in product architecture definition
- Participate in preliminary design:
 - Define acquisition and control strategies
 - Model electrical power system with power converter, sources and loads
 - Realize simulations to validate control strategy for part of different operating modes
- Work on converter detailed design:
 - Finalize simulations in continuous and discrete modes to validate control strategy for all operating modes
 - Coding, implementation and testing of control laws on control board to validate control strategy with real time constraints
- During debugging, functional and TRL3 tests: participation to converter validation.

The objectives of “Test benches” sub-work package are to:

- Definition of test plans and procedures
- Definition of ZODAERO test means.
- Design and manufacturing of ZODAERO test means

WÜRTH will support the Task 6a.2 application owner during the design-in activity of the gate-drive transformer, to make sure the component is working properly under all application conditions.

**Task 6a.3 Isolated DC-DC High Voltage to 12V for HEV, EV, FC
(VSCM leader, UNICT, NEXTER, VSCM, ZODAERO, APOJEE, aPSI^{3D}, WÜRTH, ED)
Task 6a.3 Start month T6, End Month T24**

Innovative architecture of DCDC converter, reducing magnetic components, reducing output filtering and constraints on output mosfets, within improving efficiency up to 94-95%.

This task aims to develop demonstrator.

The workflow defined for this task is:

Architecture choice: Topology, switching frequency, regulation mode T6 – T8

Prototype development (simulations, schematics, 3D, drawings, SW development) T6 – T11

Demonstrator realization (layout, manufacturing, assembly) T11 – T14

Input from WP3: Component reception for demonstrator assembly T13

Prototype functional validation, tuning, corrections T14 – T18

Product thermal, EMC & endurance test and analysis T18 – T22

WÜRTH will support the Task 6a.3 application owner during the design-in activity of the gate-drive transformer, to make sure the component is working properly under all application conditions.

**Task 6a.4 On board battery charger demonstrator
(VSCM leader, UNICT, NEXTER, VSCM, UNIPRA, ZODAERO, APOJEE, aPSI^{3D}, WÜRTH, IMA, ED)**

Task 6a.4 Start month T8, End Month T32

One of the main limitations of the BEV is the autonomy. Thanks to impressive progress in battery cells technologies and manufacturing processes, power density is increased, and price of kWh is decreasing. This task aims to develop demonstrator.

Task 6a.4 development flow will be:

Architecture choice and comparison: Topology definition T8-T12

Prototype development (simulations, schematics, 3D, drawings, layout, SW development) T15-T21

Input from WP3: Component reception for demonstrator assembly T24

Demonstrator realization (layout, manufacturing, assembly) T21-T24

Product functional validation, tuning, corrections T24-T28

Product thermal, EMC & endurance test and analysis T28-T32

WÜRTH will support the Task 6a.4 application owner during the design-in activity of the gate-drive transformer, to make sure the component is working properly under all application conditions.

IMA will cooperate with partners on demonstrator manufacturing.

Task 6a.5 High efficiency Bidirectional SiC-based Power Converter for V2G/V2H applications

(ED leader, ST-I, NEXTER, IUNET, APOJEE, WÜRTH, ED)

Task 6a.5 Start month T8, End Month T36

ED will run the pilot by leveraging the contribution of IUNET at system specifications, scientific dissemination and system validation and STMicroelectronics for power modules customization, testing and supply. Once the design will be completed, lab-level validation will be conducted interfacing the power converter with EV simulator on one side and a DC bus (storage input / PV output) on the other side.

The final test should be run in ED test centre in Italy (Milan).

WÜRTH will support the Task 6a.5 application owner during the design-in activity of the gate-drive transformer, to make sure the component is working properly under all application conditions.

Task 6a.6 Intelligent Power Switch for Railway

(NEXTER leader, ST-I, UNICT, NEXTER, ZODAERO, APOJEE, aPSI3D, WÜRTH)

Task 6a.6 Start month T6, End Month T36

SiC MOSFET Power Switch integrated in a SiC Power Module (LEG) will be developed by ST-I and during the time frame of the project.

It will be based on multi-level converters having two (or more) switches in serial for 3.3kV IPS.

In this case it's possible to use SiC 1.2kV or 1.7 kV MOSFET power switch.

The major advantage of the multi-level approach is the improvement of the form factor of power switch while disadvantage it's the complexity on the command process.

The activities have been planned to have the following milestone

Demonstrator design (NEXTER, ST-I) M6 - M12

- Power Module Architecture (NEXTER) : M6 – M8
- Power Module assembly (ST) : M8 – M12

NEXTER will design the driver part and ST the multilevel topology for the power part. The topology will be implemented in the module developed in the next task and it will use the current process.

Power module demonstrator assembly and manufacturing (ST-I) M12 - M24

This demonstrator includes a power part and a driver part

The two parts are linked together to constitute the IPS-RA demonstrator

IPS-RA demonstrator "Power integration" (thermal, packaging,...) solutions, will be managed by ST

System characterization and validation (APOJEE) M24 – M30

Functional Report will be issued with identification of points of improvements to move faster to higher TRL (NEXTER) M30-M32)

WÜRTH will support the Task 6a.6 application owner during the design-in activity of the gate-drive transformer, to make sure the component is working properly under all application conditions.

Task 6a.7 Test Bench Definition and testing
(NEXTER leader, NEXTER, ZODAERO, APOJEE, IMA)

Task 6a.7 Start month M6, End Month M36

To develop reliable, efficient and cost-effective test bench driving technology along the value chain and during the production. Target TRL 4.

MARVEL III in the WInSiC4AP project is a logical result of Power Electronic Test Benches projects previously done by APOJEE: MARVEL I & MARVEL II, electric vehicles inverters functional validation.

It will capitalize on the advantages of previous MARVEL generations, with the aim to optimize its strengths and improve them on the aspects of versatility, performance, power and simplicity of operation.

Eventually, MARVEL III will enrich the APOJEE product portfolio, and diversify the source of revenues compared to engineering activities.

Based on the APOJEE Test bench converters from VSCM, NEXTER and ZODAERO will be tested.

Cell and Rack Specification, design & risk mitigation

APOJEE will interview every partner involved in power electronic converter, in order to establish a common set of specification of the test bench, and to demonstrate the risk mitigation that can be performed by using it. (M6-M10).

The key points are:

- The full SiC implementation of a 30kW cell
- The ultra-low parasitic capacitance of this cell
- The optical fibre isolation of the communication link
- The energy dissipation in case of power source failure
- The interleaved operation on several racks and cabinets

As it is in APOJEE's knowledge, all of these points are known on some projects (often quite different from the current one for example by academic institutes or in motorsport), but no known products has (or even is closed to) all these key points.

APOJEE will design the basic components of the Test Bench, constituted by cells and racks.

The test bench is made of a unique 30kW cell, an AC/AC inverter, full SiC, build from their experience on full SiC motorsport inverter.

- **Cell design (M10):** This cell will be designed to have an ultra-low common mode parasitic capacitance, to be compliant with the operation of SiC Device Under Test. Each cell will have its own control electronics, with the capability to monitor and control the currents, voltages and frequency of its input and output.
In addition, this electronic will have the capability to dissipate the unwanted energy in case for example of main power failure.
- **Rack design (M12):** These cells are grouped to form racks, with the number of outputs needed by the various devices under test (DUT).
The simplest option should be 1 AC + 1 DC, 4 AC and 2 DC being possible for example to simulate a four wheel drive with one electric motor per wheel, powered by a fuel cell and a buffering battery.
The energy flow is internal to the architecture, allowing much quicker reactions, and better simulation of the reality
- The communication means of the cells internally to a rack are isolated through optical fibre, in order to have a negligible EMC path for any disturbance occurring on the power side.

Prototypes validation on test bench (M36)

5. ATEX impact to be assessed
6. MTBF to be evaluated (MTTR irrelevant, it manages replacement)
7. Operational Accelerations 6 g; Impact / Hard Landing to be evaluated
8. Radiant Bodies / heat dissipation to be evaluated (Baseline AL99.9%)

Task 6b.1: LiPo Interface Design
(DAC leader, DTSMNS, ST-I, UNICT, DAC)
Task 6b.1 Start month T7, End Month T18

Design of the LiPo Interface and Charger technology (Software and Hardware) to be installed in the UAV will start based on new core components technologies allowing higher temperature ad performances thus inducing a new concept of LiPo Interface for an advanced operational control of available electric power.

The LiPo charger bottom-up lining is here reported:

- Core Integrated Components (SiC)
- Ancillary Integrated Components
- Firmware to enable software dialog from End-Use to Electric Machine
- Hardware and Mechanical Integration
- Connectors and Interfaces enabling High Level Command and Sensing

Electric Power for LiPo is coming from a Fuel Cell system that is unable to face highly unsteady and peaky operational requirements, due to abrupt command or environmental condition to face automatically (i.e. gust).

Consolidated technologies today offer products capable to supply the required current and tension performance but in the present application the LiPo interface is airborne so that reliability and functional stability are central objective to aim. This specific application also requires a dramatic weight reduction research study, mandatory for a successful application.

In a mitigation risk approach, once defined advanced component specification, LiPo interface design (electric and mechanic) can be intended as modular, considering cruise propeller engine the main focus and consequently a lower density of power is required (large, quite smooth power supply for endurance).

Project development sequence is here briefly reported:

1. Advanced components specification analysis, requirement assessment (in WP 2b)
2. Electronic Layout and Preliminary Design
3. Electric Machine Software Simulation
4. Prototype (Mechanical end Electric) for Laboratory Testing Design
5. Prototype for Laboratory Testing Manufacturing
6. Laboratory Preliminary Testing
7. Critical Design Review
8. Design Completion and Review of LiPo Interface (Electric and Mechanic)
9. Demonstrator Manufacturing
10. Demonstrator Testing (Laboratory and Environmental Condition Simulation)

For DAC cluster some activities will be performed by REDAM and OMI members of linked third party CALTEC only on the ESI Funds (see 4.2 chapter).

DTSMNS through the linked party UNIPA (DEIM Department) will contribute to the design and implementation of intermediate laboratory demo for early testing purposes.

Task 6b.2: LiPo Interface Realization and Testing
(DAC leader, DTSMNS, ST-I, UNICT, SOFT, DAC)
Task 6b.2 Start month T19, End Month T36

During development phase Interface of LiPo charger with other components of UAV systems will be also analysed. A specific focus will be on heat exchange technologies and on mechanical design for installation, considering temperature effect and compactness and antithetic requirements.

Final experimental campaign will be on the ground, in Laboratory facilities; flight testing will be eventually performed according to permission to fly dealing with national regulation and UAV test machine availability. Anyway, in case flight operation will not be allowed, test will be performed considering environmental "heavy condition" (hot and Dry) and GVT (Ground and Vibration Test). Demonstrator testing operation will also be performed in off-design condition (heavy duty, disturbance, shocks, etc.).

For DAC cluster some activities will be performed by REDAM and OMI members of linked third party CALTEC only on the ESI Funds (see 4.2 chapter).

DTSMNS trough the linked party UNIPA (DEIM Department) will contribute to the design and implementation of intermediate laboratory demo for early testing purposes.

**Task 6b.3 Engine Controller-Inverter Design
(DAC leader, DTSMNS, ST-I, UNICT, DAC, SOFT)**

Task 6b.3 Start month T7, End Month T18

Design of the new inverter technology (Software and Hardware) to be installed in the UAV will start on the basis of new core components technologies allowing higher temperature ad performances thus inducing a new concept of inverter design.

Consolidated technologies today offer products capable to operate at the required current and tension performance, but in aerospace application inverter and controllers are airborne, so that reliability and functional stability are main objectives to aim. This specific application requires a dramatic weight reduction research study, mandatory for a successful application, as well as effective energy management optimization strategies.

Due to the specific UAV design, different power units are installed, so that in a mitigation risk approach once defined advanced component specification, controller design (electric and mechanic) can be intended as modular (or multiple channel/Dual Drive), considering cruise propeller engine the main focus; other equipments require higher power density operation to be derived/scaled from the cruise power supply line.

The Controller-Inverter bottom-up lining is here reported:

- Core Integrated Components (SiC)
- Ancillary Integrated Components
- Firmware to enable software dialog from End-Use to Electric Machine
- Hardware and Mechanical Integration
- Connectors and Interfaces enabling High Level Command and Sensing

For DAC cluster some activities will be performed by REDAM and OMI members of linked third party CALTEC only on the ESI Funds (see 4.2 chapter).

DTSMNS trough the linked party UNIPA (DEIM Department) will contribute to the design and implementation of intermediate laboratory demo for early testing purposes.

Project Development sequence is here briefly reported:

1. Advanced components specification analysis, requirement assessment (in WP 2b)
2. Electronic Layout and Preliminary Design
3. Electric Machine Software Simulation
4. Prototype (Mechanical end Electric) for Laboratory Testing Design
5. Prototype for Laboratory Testing Manufacturing
6. Laboratory Preliminary Testing

The objective is structured on three levels:

- 1) Definition and execution of the dissemination activities arranged into a logical sequence during the project life time. The activities are aimed to support the widest adoption of project results in education, research, industry and creation of market opportunities for the participants.
- 2) Definition and execution of the exploitation activities essential to maximize the strategic socio-economic impact and technology transfer to the market. This will be addressed by the Partners specifically involved in the Avionics & HEV activities.
- 3) Definition and execution of the specific activities related to standardization issue, voltages, recommendations for development, process and maintenance in life of new power components.

The activities detailed above will greatly benefit from a well-balanced, competent and comprehensive consortium, including engineers and scientists from industry and SME's, as well as researchers, instructors and students from educational institutions and research centres. Due to the worldwide influence of the material manufacturers, equipment developers and system-integrator partners, the consortium will be able to provide a direct exploitation path and will be able to guarantee dissemination of the developed IPs at the highest level.

Description of work

Strong communication activities will be carried out to disseminate the progresses and the results obtained during the project duration. Dissemination phase will take place in networks and conference events. Other specific communication means (e.g., press releases) will be used to intercept the Avionic, Railway and HEV community.

Task 7a.1 Dissemination and Communication Strategies in Avionics, Railway & Automotive HEV fields.

(CNR leader, ST-I, UNICT, NEXTER, VSCM, IUNET, UNIME, UNIPRA, LUH, CNR, ZODAERO, APOJEE, aPSI3D, WÜRTH, UNITOU, IMA, ED)

Task 7a.1 Start month T1, End Month T30

The project results will be disseminated and communicated to the potential stakeholders using different channels.

First a project web site will be created and linked in/to the websites of the project partners. Besides the general description of the project objectives and activity, this platform will include an area restricted only to the consortium partners, in order to exchange confidential project results and administrative documents.

A document including all the dissemination activities (conferences, papers, etc.) will be prepared at the beginning of the project and will be regularly updated by all the partners, during the preparation of the periodical project reports. This database will also serve to keep updated the section of the dissemination in project web site.

For the scientific community, the dissemination will be done through publications of paper in peer reviews journals (see section 2.2 for details). A common press release will be done at the beginning of the project, to advertise the wide public of this new initiative.

All the involved partners will share information about the project progress reports also on their local web-sites.

Task 7a.2 Publications, Conferences and Workshops

(IUNET leader, ST-I, NEXTER, VSCM, IUNET, UNIME, UNIPRA, LUH, CNR, ZODAERO, APOJEE, aPSI3D, WÜRTH, UNITOU, IMA, ED)

Task 7a.2 Start month T1, End Month T36

This task groups and coordinates all activities aimed at promoting the visibility of the project technical results at the national and international level, via papers in scientific journals, presentations at international conferences, meetings and workshops, participation in activities such as tutorials, panels, round tables and seminars in international events, as well as to summer courses and targeted dissemination actions regularly organized by the scientific community.

A measure of success of the scientific impact of the project will be the number of the contributions to leading international journals and conferences and the invited presentations by the partners.

Peer-reviewed international journals specialized in compound semiconductor are targeted, such as: IEEE Transactions on Electron Devices, IEEE Electron Device Letters, IEE Electronics Letters, IEEE Transactions on Device and Materials Reliability, Journal of Aeronautics & Aerospace Engineering (see section 2.2 for details).

Relevant conferences and workshops specialized in compound semiconductor are targeted, such as : IEEE IEDM, IEEE IRPS, ESREF, ESSDERC, ECSCRM/ICSCRM, WOCSDICE/EXMATEC, PCIM, Automotive Power electronic congress (APE) & JSAE Japan (see section 2.2 for details).

The dissemination plan will also include the organization of two technical workshops as satellite events of major international conferences in the field of SiC technology development and applications in power electronics systems, such as for instance ESSDERC, ECSCRM/ISCRM or WOCSDICE. Attendance and impact metrics as well as feedback from audience will be collected and reported.

Task 7a.3 Participation in Avionics, Railway & Automotive Standardization committee (ST-I Leader, ST-I, NEXTER, VSCM, ZODAERO, APOJEE, aPSI3D, WÜRTH)

Task 7a.3 Start month T6, End Month T36

Project partners (mostly the industrial ones) are involved in the related standardization and regulation organizations. Specifically for the project, this involvement is related to the need to define standard high performance packages/new materials for high temperature, high power and high current applications.

Task 7a.4 Exploitation in Avionics, Railway & Automotive fields

(NEXTER Leader, ST-I, NEXTER, VSCM, IUNET, UNIPRA, LUH, CNR, ZODAERO, APOJEE, aPSI3D, WÜRTH, UNITOU, IMA, ED)

Task 7a.4 Start month T12, End Month T36

The partners will develop and maintain individual exploitation strategies, which will be collected in a common WInSiC4AP Exploitation Plan. This plan will be updated every 12 months. The plan will also specifically include the list of patents generated by the partners during the duration of the project. The exploitation strategy will be strengthened by the organization of annual InfoDays, in order to identify potential customers in Avionics, Railway and HEV fields.

ED will contribute to define the strategy for a full exploitation of V2G/V2H.

Fair and Conference are detailed in Section 2.

The project results will be disseminated and communicated to the potential stakeholders using different channels.

A document including all the dissemination activities (conferences, papers, etc.) will be prepared at the beginning of the project and will be regularly updated by all the partners, during the preparation of the periodical project reports.

A section of the WInSiC4AP web site, developed in WP7a, will be specifically dedicated to the activities of the WP7b, that will be kept updated according to the above mentioned document.

For the scientific community, the dissemination will be done through publications of papers in peer reviews journals. A special issue on WInSiC4AP WPnb results in avionics applications will be scheduled at the end of project activities on the international journal *Aerotecnica Missili e Spazio* published by AIDAA (Italian Association of Aeronautics and Astronautics).

On the other hand, the industrial partners will periodically communicate the project results through press releases. A common press release will be done at the beginning of the project within WP7a, to advertise the wide public of this new initiative.

Task 7b.2 Conferences and Workshops in Avionics

(DTSMNS Leader, DSTMNS, ST-I, UNICT, UNIME, CNR, SAT, SOFT, DAC)

Task 7b.2 Start month T1, End Month T36

This task groups and coordinates all activities aimed at promoting the visibility of the project technical results at the national and international level, via scientific presentations at international conferences, meetings and workshops, participation to activities such as tutorials, panels, round tables and seminars in international events, as well as to summer courses and targeted dissemination actions regularly organized by the scientific community.

A measure of success of the scientific impact of the project will be the number of the contributions to leading international conferences and invited presentations by the partners.

As WP7a targets for specialized compound semiconductor conferences, this WP aims to approach also the communities/markets of the end users in Avionics and Aviation in general. Therefore, we also target international congresses like CEAS, ICAS, AIAA, RPS International and IAF for the aerospace sector. The biannual (2017-2019-2021) international conference of AIDAA (Italian Association of Aeronautics and Astronautics) will be considered for thematic sessions on WInSiC4AP activities. The 2017 edition of the AIDAA Conference will be held in Sicily (Palermo) and will serve for presentation of the project in the framework of Aviation stakeholders.

The dissemination plan will also include the participation to technical workshops as satellite events of major international conferences in the field of SiC technology development and Avionics applications. Specific seminar and workshops will be devoted to the Italian Aerospace Cluster (Lombardia, Piemonte, Emilia and Puglia).

A summer school for young students and/or engineers will be organized on the application of new SiC technologies in Avionics. This will contribute to promote the development of a new generation of technicians skilled in advanced application of SiC.

Task 7b.3 Participation in Avionics Standardization committee

(DTSMNS Leader, DSTMNS, ST-I, SAT, SOFT, DAC)

Task 7b.3 Start month T6, End Month T36

Project partners (mostly the industrial ones) are involved in the related standardization and regulation organizations. Considering the certification rules in aviation a mid term review on the WInSiC4AP WPnb results in avionics applications will be carried out. On the basis of this check, if needed, interaction with Avionics Standardization committees will be activated to adapt/revise/define standard

Spreading of the 132 deliverables during the execution of the Project

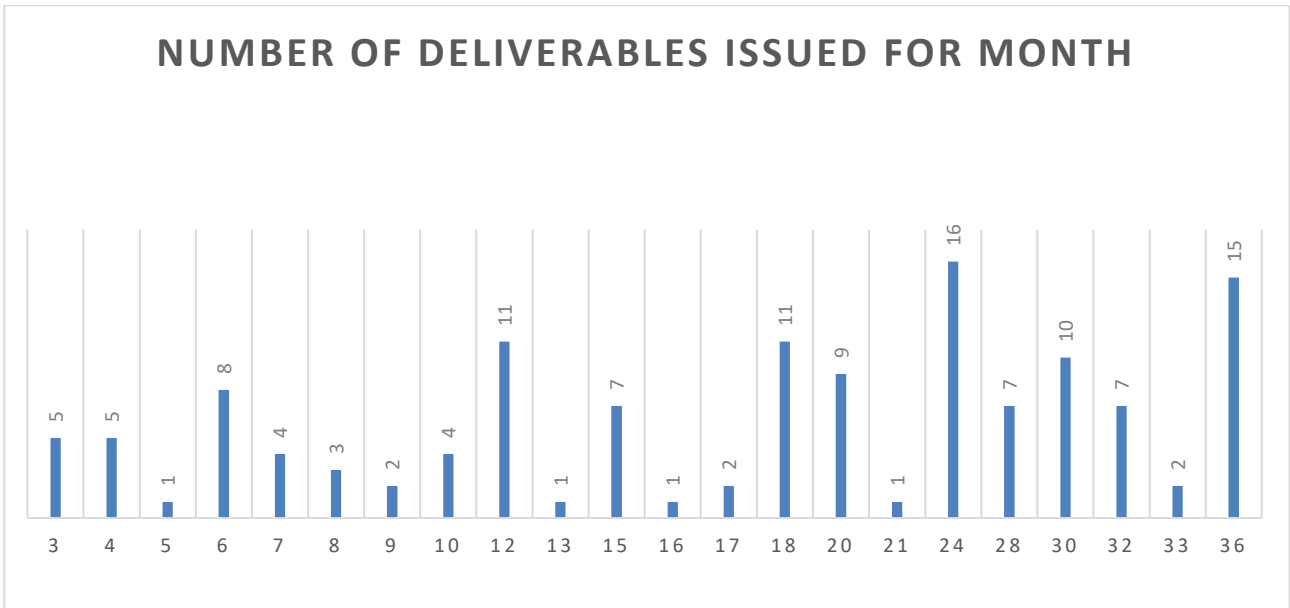

KEY

Deliverable numbers in order of delivery dates. Please use the numbering convention <WP number>.<number of deliverable within that WP>.

For example, deliverable 4.2 would be the second deliverable from work package 4.

Type:

Use one of the following codes:

- R: Document, report (excluding the periodic and final reports)
- DEM: Demonstrator, pilot, prototype, plan designs
- DEC: Websites, patents filing, press & media actions, videos, etc.
- OTHER: Software, technical diagram, etc.

Dissemination level:

Use one of the following codes:

- PU = Public, fully open, e.g. web
- CO = Confidential, restricted under conditions set out in Model Grant Agreement
- CI = Classified, information as referred to in Commission Decision 2001/844/EC.

Delivery date

Measured in months from the project start date (month 1)

KEY

Estimated date

Measured in months from the project start date (month 1)

Means of verification

Show how you will confirm that the milestone has been attained. Refer to indicators if appropriate. For example: a laboratory prototype that is 'up and running'; software released and validated by a user group; field survey complete and data quality validated.

3.2 Management structure and procedures

The management approach for WInSiC4AP project builds upon the structures and procedures of former ENIAC projects (e.g. Call 1 “MODERN” and Call 2 “END”, “CSI”, “LASTPOWER”, “ERG”) and former FP7 IP/H2020 projects (e.g., “THERMINATOR”, “NANOCMOS”, “PullNANO”, “CHALLENGE”) together with ECSEL running project (i.e. R2POWER300) that has been already adopted for complex projects. The management structures of such projects have proven to be adequate, efficient and able to quickly respond to any changes and threats to the project. As such, it will be applied to WInSiC4AP project with some adjustments to take care of specific requirements of the ECSEL 2016 RIA Call, the targeted TRL, the WInSiC4AP Consortium dimension and the funding strategies based on JU, national and ESI funding synergism.

The project management will consist of the following structures and functions, whose interactions are shown in the figure below.

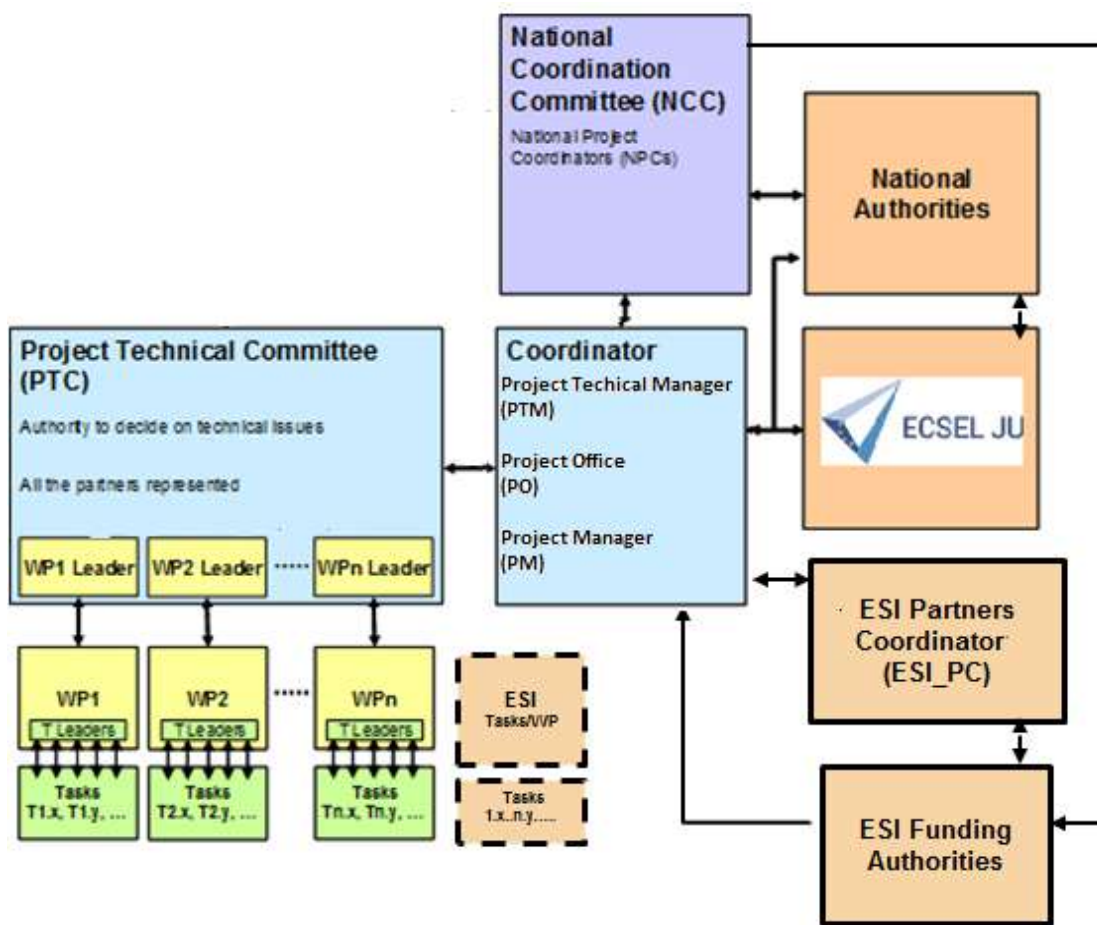

Figure 41: Project management structure.

- Project Technical Committee (PTC)
- Project Manager (PM)
- Project Technical Manager (PTM)
- Exploitation Manager (EM)
- Work-Package Leaders (WPLs)
- Task Leaders (TLs)
- Project Office (PO)
- National Coordination Committee (NCC)

- National Project Coordinators (NPCs)
- ESI Partner Coordinators (ESI_PC)

The project is coordinated by the Project Technical Manager (PTM) on scientific issue, and by Project Manager (PM), leading Project Office (PO,) about all management issues and on all organizational project-related issues.

Project Technical Committee (PTC) decides on all technical scientific project-related issues and the Project Technical Manager (PTM) will implement PTC guideline technically coordinating the Partners.

Each project work-package will be coordinated by the corresponding Work-Package Leader (WPL). Each project Task will be coordinated by the corresponding Task Leader (TL).

The PO is the main interface to the JU. The liaison of the PO to the National Authorities is provided by the National Coordination Committee (NCC), which is composed of the National Project Coordinators (NPCs).

Specific attention will be put by PTC in maintaining clear separation between JU-ECSEL/National Funding and ESIF funding and separation between Management for FE/BE for Avionics, Railway and Automotive IPS and Management for Low-voltage Avionics and Engine control.

Also, the Coordination Team (PTM+PM+PO) will take care of the agenda of the conference calls and meetings that have been scheduled as follows:

- for technical exchanges between the partners contributing to a specific Task, checking the progress of the work of that task → every month
- for technical exchanges between the partners contributing to a specific WP, checking the progress of the work and ensuring the on-time availability of WP deliverables → every 3 months.

The Project Technical Committee (PTC) nominates the Exploitation Manager (EM) and the ESIF Exploitation Manager to promote results diffusion in ESI funding region to have impact at the level of enabling improved cohesion at European level. Partners that have a strong presence in South regions and that combines activities, advanced research and production (they are recognized among the relevant cluster of expertise at European and international level) will strengthen the virtuous combination and co-location of research, funding availability and advanced manufacturing.

ESIF Exploitation Manager has to highlight at any level the coherence between project priorities and the specializations of each territory, through their development and enhancement, to trigger the different developments with the ability to realize the investments.

Project Manager (PM) and Project Office (PO)

The project will be coordinated by the PM, who will be properly supported by PO for administrative issue.

It is responsible for the following tasks:

- Interfacing to the JU, the NCC and ESI_PC
- Distribution of the ECSEL funding
- Preparation of Reviews and Project meetings (PCC, PTC)
- Chairing PTC
- Negotiation on contract, budget, Consortium Agreement, LOI
- Management of the Consortium in the wide sense on a continuous basis

Administrative management is also the responsibility of the Project Office. The Project Office is located at the Coordinator's site. The main responsibilities of the Project Office are:

- Deciding on adaptations of the work-plan
- Agreeing on the (re) allocation of the project's budget

- Making proposals for reviewing/amending the contract, if the case
- Taking measures to cope with defaulting partners
- Maintaining the Consortium Agreement
- Appointing the Exploitation Manager
- Organizing meetings of members of the Consortium
- Taking care of payment's delivery to the partners
- Collecting documentation, for the monitoring of the activities within the WPs
- Controlling the financial reports from the individual groups
- Collecting deliverables for submission to the JU
- Preparing a detailed list of deliverables, partner contact information, preparing and updating of the project calendar, establishing mailing lists.
- The PM will be supported by the Project Technical Manager (PTM) for the scientific issue.

Project Technical Committee (PTC)

The PTC is composed of the WP Leaders and, since all partners in the Consortium shall be represented in the PTC, (co-opted) partner representatives (including ESI Partners), plus the PM, EM and ESIF EM. The representative in the PTC shall be able to make decisions as to the particular technical interests and how to use the resources allocated to achieve the project's goals. The members of the PTC will be appointed by each of the prime partners. The PTM will chair the PTC with the support of PM. The PTC is responsible for the monitoring of the project progress and the preparation, review and updating of the detailed work-plan. The decisions will be taken by consensus or by a double majority in the case where consensus is not possible. Each member of the PTC will have one vote, except the PM and EM, unless they are delegated by any other member. Changes to the work-plan will require consensus or a double majority. The PTC will meet every 3 months. Meetings will be generally held by telephone conference. The voting procedure as well as the responsibilities of the PTC will be laid down in the Consortium Agreement (EPCA). The main responsibilities are summarized as:

- Coordinating the overall technical work on a continuous basis
- Coordinate the interaction and collaboration across Activities
- Budget (re)allocation and work-plan adaptation, when and if needed.

Project Technical Manager (PTM)

The Project Technical Manager (PTM) is appointed by the Coordinator. The PTM will implement PTC guideline technically coordinating all the Partners on scientific issues, and he/she is in charge of the daily technical management of the project.

Exploitation Manager (EM)

The Exploitation Manager (EM) will be responsible for the day-by-day management of the project exploitation activities. He will be in charge of the coordination of the exploitation actions for the WInSiC4AP Consortium as a whole. The Exploitation Manager is a voting member of PTC, and is appointed by the PTC.

WP Leader (WPL) and Task Leader (TL), (including ESI WP Leaders and ESI Task Leaders)

The main responsibilities of the **Work Package Leaders** are summarized as:

- Co-ordinate the work in the WP
- Ensure a close communication among the participants
- Convene WP internal meetings
- Ensure the on-time availability of WP deliverables
- Participate to the meetings of the PTC
- Report progress and deviations from the work-plan to the PO and the PTC

WP Leaders are assisted by **Task Leaders**, whose mission is to:

- Organize the technical exchanges between the partners contributing to the Task
- Check the progress and on-time delivery of the Deliverables of the Task
- Report to the Work Package leader, who will be coordinating all Tasks of his WP.

National Project Coordinators (NPCs)

The partners of each country represented in the project nominate among them one, representative as their National Project Coordinator (NPC). The NPCs are appointed for the whole duration of the project and are responsible for coordinating the administrative actions internally to the national partnership of concern and to act as the interface towards the corresponding Public Authorities.

ESI Partners Coordinator (ESI_PC)

The partners of region/country, supported by ESI Funding, nominate among them, one representative as their “*ESI Partner Coordinator*”. The *WinSiC4AP proposal* will include participant located in south Italy involved in WP and tasks in which ESI funding authorities expressed interest to support the proposal to enhance activities and results having immediate impact at local level. ESI_PC will manage the interactions of the local clusters/partner consortium with the local public authorities including tasks such as budget negotiations and contract issues. He will work to guarantee coordination with project as a whole and to minimize the risk as for the best mitigation measures (according to Table 3.2b: critical risks for implementation). In particular he will care ESI Funds management towards regional Cluster/partner and relevant Local Authorities. The ESI_PC acts as information, communication and coordination channel for all partners in its ESI region. He/she ensures that all ESI funded partners follow the region specific rules and requests about the *WinSiC4AP* project.

National Coordination Committee (NCC)

The NCC consists of all the National Project Coordinators and **ESI Partners Coordinator (ESI_PC)**. It is in charge of interfacing with the National Authorities and ESIF Authorities for tasks such as budget negotiations and contract issues, as well as with the JU. In particular, the NCC coordinates activities related to EU and/or country policies and rules. The formal delegate acts as information, communication and coordination channel for all partners in his/her country. He/she ensures that all partners follow both the EU and country specific rules and requests about the project.

Table 3.2a: List of milestones (removed)

Table 3.2b: Critical risks for implementation (removed)

An evaluation of the risks identified in the project has been made putting in relation the two dimensions:

- the probability that the risk happen
- its severity

obtaining the following risk level matrix:

		Severity				
		1 Not important	2 Minimum	3 Appreciable	4 Critical	5 Threatening
The probability that it appens	5 Frequent	M	H	VH	VH	VH
	4 Possible	L	M	H	VH	VH
	3 Rare	L	M	M	H	VH
	2 Very rare	L	L	L	M	H
	1 Improbable	L	L	L	L	M

L	Low Risk: no actions
M	Medium Risk: adopt actions to mitigate the risk
H	Hight Risk: adopt actions to avoid and mitigate the risk.
VH	Very High Risk: not acceptable.

In the project hasn't been identified any VH risk.

In relation to the table at the point "1.3.5. WT5 Critical Implementation risks and mitigation actions" for the project reported in the Annex 1 part A the following risk evaluation levels has been identified:

Risk Number	Description of risk	Probability	Severity	Evaluation
1	Synthesis of overall Specifications	4	3	H
2	Link between Reliability and failure model analysis and change of design rule	4	2	M
3	Advanced processes and materials technology implementation	4	2	M
4	Module prototype delay	3	3	M
5	Passive Components delay	3	2	L
6	Demonstrators success	2	4	M
7	WInSiC4AP ESIF delayed as planned for the project starting date	5	2	H

3.3 Consortium as a whole

The WInSiC4AP Consortium is building to acquire the needed capabilities by leveraging the competencies from the industry’s Large and Small Medium Enterprises and Academic Institutions. The value chain represented in the project is from the ECS manufacturer up to the TIER1 or final End USER

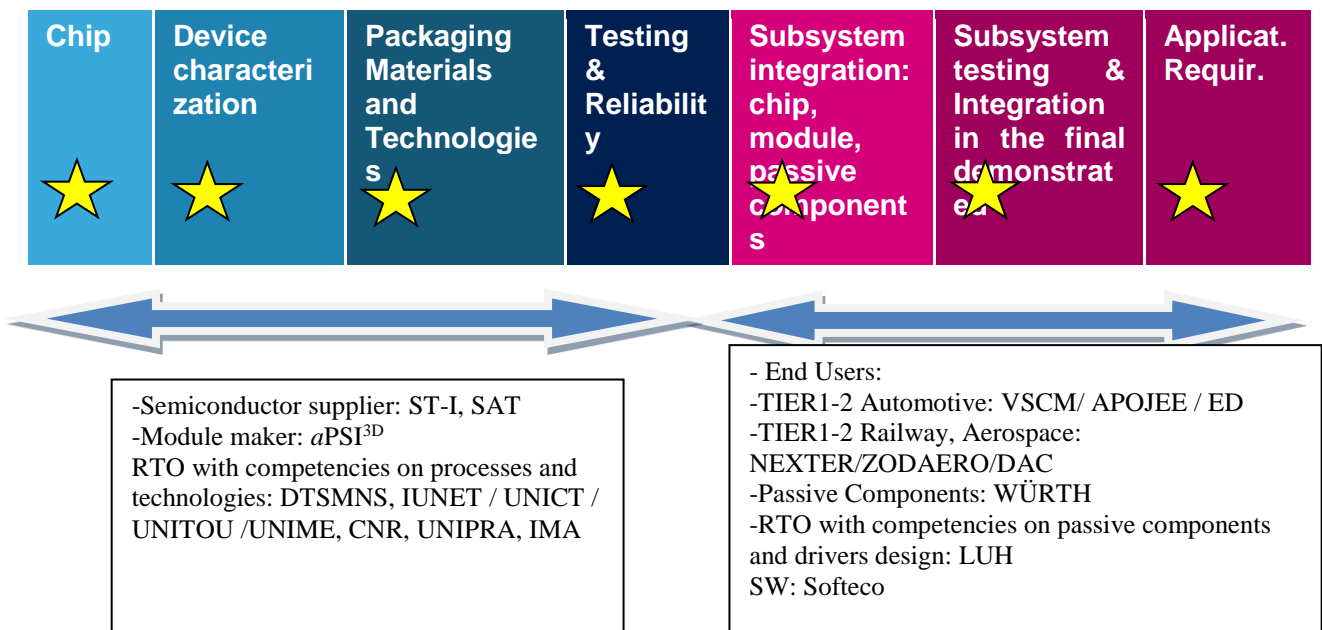

Figure 42: WInSiC4AP Consortium chain

Activities have been planned to ensure full interactions among the partners by focusing at the same time the effort; so each partner is strongly involved in one task without spreading his effort in various minor activities.

Particularly relevant is the role of Industries that will contribute directly in the project to define specifications about Automotive (HEV), Railway and Aerospace , that are in strong connection with their TIER1, TIER2 (VSCM, APOJEE, ED, NEXTER, ZODIAC, DAC). In particular Sothern Italian and European SMEs have been an important consideration when the consortium has been shaped and in the proposing project. Fostering innovative SME’s is a pillar of the project and Consortium strategy given the importance of SME’s for the size and increase of market share and finally employment in Europe in the ECS domain including ESIF partners located in less developed regions.

Industrial and commercial involvement in the project is ensured by the presence of Industries that represents in terms of effort the greater part of the overall WInSiC4AP project cost.

The Europe 2020 strategy towards smart, sustainable and inclusive growth will be so supported by this project approach enhancing activities and results at local, national and European level.

Consortium have been built according to its ambition and foreseen target on impacts for:

- Key Applications for Smart Energy and Smart Mobility
- Key Capabilities in Essential Technologies (Process, device, design, package) and Smart Systems covering all the value chain.

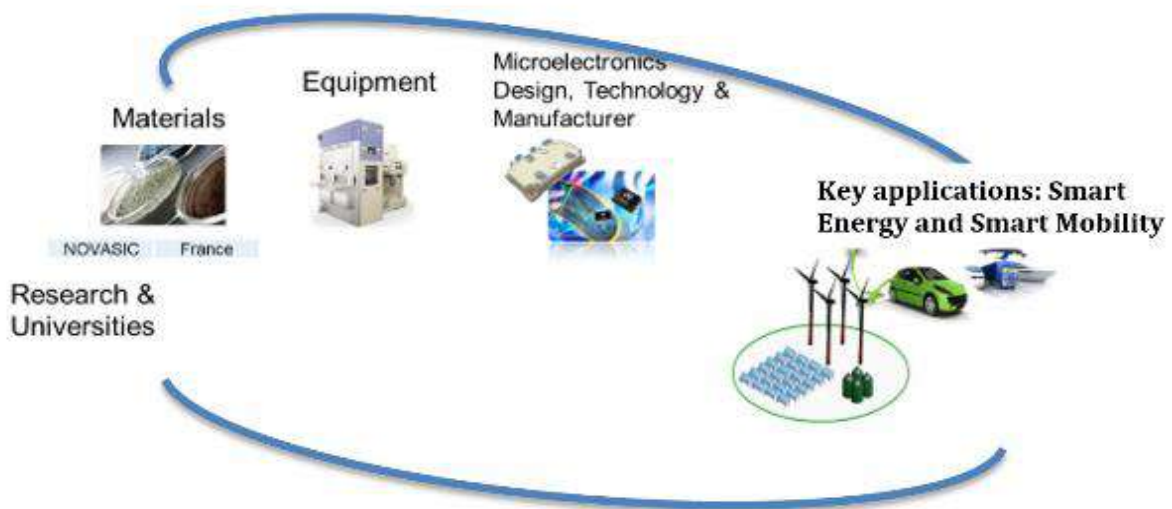

Figure 43: Consortium values

Work Package structure will promote the cooperation between “geographical cluster” and “less developed regions”.

Taking profit of the EU Regulation no. 1303/2013 the Italian Ministry of Research and Education (MIUR) adopted proper procedures to strengthen complementarity and synergies between the different EU instruments consistent with the guidelines defined by the European Commission. Since the work program ECSEL is consistent with the national RIS3 these additional resources enable southern Italy industries, research institutions and universities to participate in this international cooperation projects. WInSiC4AP has an highly strategic potential and a significant economic and social impact as identified by the Workprogramme JTI ECSEL (Smart Mobility, Smart Society, Smart Energy, Smart Production). It is consistent with the objectives and expected results in the context of national operative program for Research and Innovation (PON R&I).

ESI funding ensures the possibility to enlarge the project scope even to the avionic domain involving RTO (UNIME, UNICT, DTSMNS and CNR) and SMEs (DAC, Softeco, SAT) located in less developed regions of south Italy. The opportunities to involve SMEs has generally been addressed involving both SMEs acting at European level (IMA, APOJEE, aPSI^{3D}) and a cluster of SMEs based in South Italy.

As regards Large Enterprises VSCM, WÜRTH, NEXTER and ED will be able to drive, as key partners, each relevant application specifications. ST-I will provide the enabling technology to each application domain.

Particularly relevant is the role of Industries(cfr. table 3.4a)that will contribute directly in the project to define specifications on automotive (VSCM, ED, ZODIAC, NEXTER and DAC)), which, in strong connection with their TIER1 partners , will be able to drive part of the specifications.

Moreover, members have been associated overcoming geographical boundaries and taking care of funding sources:

- WP3a on FE/BE Advanced Technology bricks development and characterization is mainly concentrated in Italy and France enforcing the ecosystem already sustained by important initiatives like TOURS2015 and national Italian programs on KETs. Innovation in passive components is mainly concentrated in Germany. In WP6a most effort demanding demonstrator is involving France (VSCM, NEXTER, ZODAERO) and Italian companies (ED, DAC) including in the value chain WÜRTH. 8 of partners are supported by ESIF (see table 3.4c).

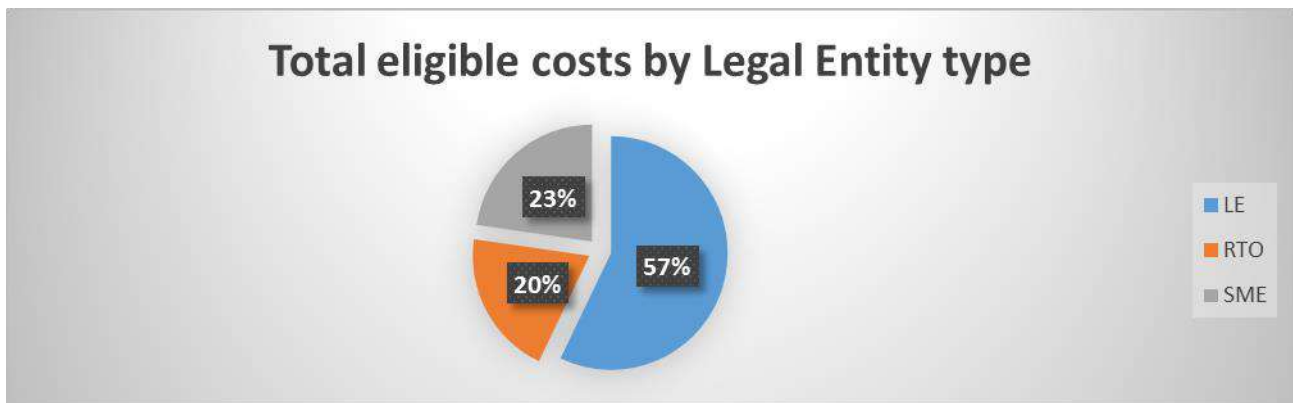

Figure 44 WInSiC4AP Total Eligible costs by Legal Entity type

Industrial and commercial involvement in the project is ensured by the presence of Industries that represents in terms of budget the 80% of the overall WInSiC4AP project cost.

The SMEs involvement is 23% in term of cost (see Figure 44) and 21% in terms of effort (see Figure 46).

In terms of geographical balance, WInSiC4AP is mostly distributed among 4 countries (Italy, France, Check Republic, Germany). Italy and France have the major budget as they are represented by the majorities of Large Enterprise and Italy.

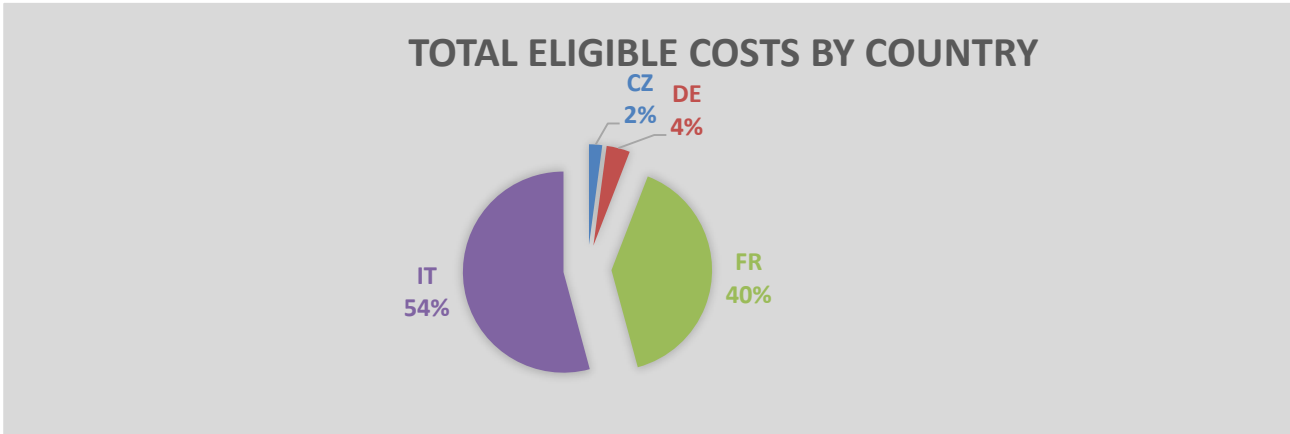

Figure 45a WInSiC4AP Total Eligible costs Cost by Country

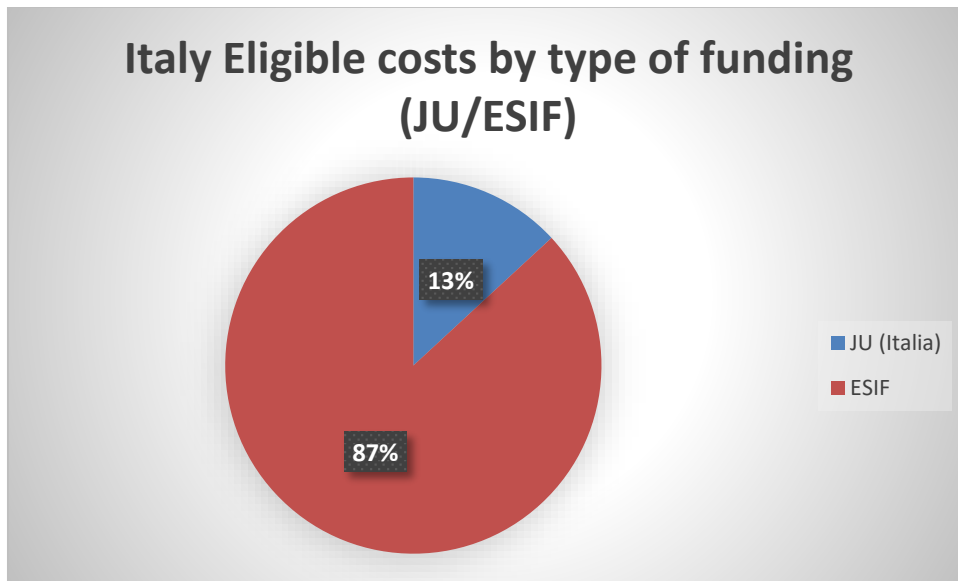

Figure 45b WInSiC4AP Italy Eligible costs by type of funding (JU/ESIF)

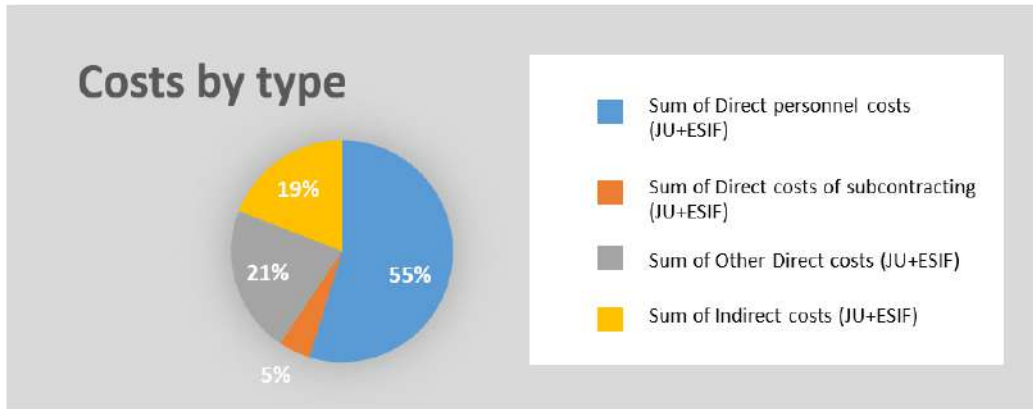

Figure 45c WInSiC4AP Total Eligible costs by type

3.4 Resources to be committed

Table 3.4a: Summary of staff effort (removed)

Please indicate the number of person months over the whole duration of the planned work, for each work package, for each participant. Identify the work-package leader for each WP by showing the relevant person-month figure in bold.

The following table shows the Partner - Person-month per year per work package

Contract Number:		737483		Partner - Person-month per work package																									
Acronym:		WinSiC4AP																											
(To be used in periodic reporting) Period:																													
		Total	1 / DTSMS	1 / DTSMS-UNPA	2 / DT4	3 / UNCT	4 / NEXTER	5 / VSON	6 / UNET	6 / UNEF-UNPD	6 / UNEF-UNBO	6 / UNEF-UNCAL	7 / UNME	8 / UNIFA	9 / LUH	10 / CNR	11 / ZODAIERO	12 / APOBEE	13 / APSI	14 / SAT	15 / WURTH	16 / UNTOU	17 / INA	18 / ED	19 / SOFT	20 / DAC	20 / DAC-Callcenter M	20 / DAC-Callcenter/OMI	
Work package 1: <1a - Management and Coordination FE/BE for Avionics, Railway and Automotive IPS>	WP1 total acc to Annex-1	63,0	43,0	0,0	20,0	0,0	0,0	0,0	0,0	0,0	0,0	0,0	0,0	0,0	0,0	0,0	0,0	0,0	0,0	0,0	0,0	0,0	0,0	0,0	0,0	0,0	0,0	0,0	0,0
	Planned Year 1	21,0	15,0		6,0																								
	Planned Year 2	19,0	11,0		8,0																								
	Planned Year 3	23,0	17,0		6,0																								
WP1 cumulative planned		63,0	43,0	0,0	20,0	0,0	0,0	0,0	0,0	0,0	0,0	0,0	0,0	0,0	0,0	0,0	0,0	0,0	0,0	0,0	0,0	0,0	0,0	0,0	0,0	0,0	0,0	0,0	0,0
Work package 2: <1b - Management and Coordination FE/BE Low Voltage for Avionics & Engine control>	WP2 total acc to Annex-1	23,0	3,0	0,0	20,0	0,0	0,0	0,0	0,0	0,0	0,0	0,0	0,0	0,0	0,0	0,0	0,0	0,0	0,0	0,0	0,0	0,0	0,0	0,0	0,0	0,0	0,0	0,0	0,0
	Planned Year 1	7,0	1,0		6,0																								
	Planned Year 2	9,0	1,0		8,0																								
	Planned Year 3	7,0	1,0		6,0																								
WP2 cumulative planned		23,0	3,0	0,0	20,0	0,0	0,0	0,0	0,0	0,0	0,0	0,0	0,0	0,0	0,0	0,0	0,0	0,0	0,0	0,0	0,0	0,0	0,0	0,0	0,0	0,0	0,0	0,0	0,0
Work package 3: <2a - Requirements and Use Case Definition>	WP3 total acc to Annex-1	158,0	0,0	0,0	35,0	8,0	9,0	37,0	0,0	0,0	0,0	0,0	1,0	24,0	3,0	0,0	0,0	0,0	0,0	0,0	0,0	0,0	0,0	0,0	0,0	0,0	0,0	0,0	0,0
	Planned Year 1	116,0			25,0	6,0	7,0	31,0					1,0	18,0	1,0														
	Planned Year 2	38,0			10,0	2,0	2,0	6,0					0,0	6,0	2,0														
	Planned Year 3	4,0			0,0	0,0	0,0	0,0					0,0	0,0	0,0														
WP3 cumulative planned		158,0	0,0	0,0	35,0	8,0	9,0	37,0	0,0	0,0	0,0	0,0	1,0	24,0	3,0	0,0	0,0	0,0	0,0	0,0	0,0	0,0	0,0	0,0	0,0	0,0	0,0	0,0	0,0
Work package 4: <2b - Avionics Interface and Engine Control and Use Case Definition>	WP4 total acc to Annex-1	96,0	0,0	4,0	35,0	18,0	0,0	0,0	0,0	0,0	0,0	0,0	0,0	0,0	0,0	0,0	0,0	0,0	0,0	0,0	0,0	0,0	0,0	0,0	0,0	0,0	0,0	0,0	0,0
	Planned Year 1	68,0		4,0	35,0	3,0																							
	Planned Year 2	18,0			0,0	9,0																							
	Planned Year 3	10,0			0,0	6,0																							
WP4 cumulative planned		96,0	0,0	4,0	35,0	18,0	0,0	0,0	0,0	0,0	0,0	0,0	0,0	0,0	0,0	0,0	0,0	0,0	0,0	0,0	0,0	0,0	0,0	0,0	0,0	0,0	0,0	0,0	0,0
Work package 5: <3a - FE/BE Advanced technology bricks development & characterization (1200-1700V SIC)>	WP5 total acc to Annex-1	299,0	0,0	0,0	75,0	0,0	0,0	0,0	0,0	0,0	0,0	0,0	0,0	26,0	66,0	10,0	0,0	14,0	0,0	26,0	64,0	18,0	0,0	0,0	0,0	0,0	0,0	0,0	0,0
	Planned Year 1	80,0			15,0									8,0	20,0	3,0				6,0	20,0	2,0							
	Planned Year 2	138,0			45,0									14,0	23,0	4,0				6,0	12,0	24,0	10,0						
	Planned Year 3	81,0			15,0									4,0	23,0	3,0				2,0	8,0	20,0	6,0						
WP5 cumulative planned		299,0	0,0	0,0	75,0	0,0	0,0	0,0	0,0	0,0	0,0	0,0	0,0	26,0	66,0	10,0	0,0	14,0	0,0	26,0	64,0	18,0	0,0	0,0	0,0	0,0	0,0	0,0	0,0
Work package 6: <3b - FE/BE Low Voltage high current technology bricks development & characterization (650V @400A SIC)>	WP6 total acc to Annex-1	138,0	0,0	0,0	80,0	0,0	0,0	0,0	0,0	0,0	0,0	0,0	0,0	18,0	0,0	0,0	30,0	0,0	0,0	10,0	0,0	0,0	0,0	0,0	0,0	0,0	0,0	0,0	0,0
	Planned Year 1	31,0			20,0									2,0			7,0			2,0									
	Planned Year 2	69,0			40,0									10,0			16,0			3,0									
	Planned Year 3	38,0			20,0									6,0			7,0			5,0									
WP6 cumulative planned		138,0	0,0	0,0	80,0	0,0	0,0	0,0	0,0	0,0	0,0	0,0	0,0	18,0	0,0	0,0	30,0	0,0	0,0	10,0	0,0	0,0	0,0	0,0	0,0	0,0	0,0	0,0	0,0
Work package 7: <4 - Open platform and Design Methodologies>	WP7 total acc to Annex-1	68,0	0,0	0,0	35,0	0,0	0,0	23,0	0,0	0,0	0,0	0,0	0,0	10,0	0,0	0,0	0,0	0,0	0,0	0,0	0,0	0,0	0,0	0,0	0,0	0,0	0,0	0,0	0,0
	Planned Year 1	16,0			5,0			9,0						7,0						2,0									
	Planned Year 2	44,0			25,0			12,0						2,0						3,0									
	Planned Year 3	8,0			5,0			2,0						1,0						5,0									
WP7 cumulative planned		68,0	0,0	0,0	35,0	0,0	0,0	23,0	0,0	0,0	0,0	0,0	0,0	10,0	0,0	0,0	0,0	0,0	0,0	0,0	0,0	0,0	0,0	0,0	0,0	0,0	0,0	0,0	0,0
Work package 8: <5a - Reliability 1200-1700V SIC>	WP8 total acc to Annex-1	233,0	0,0	0,0	50,0	0,0	0,0	30,0	0,0	55,5	37,5	28,0	0,0	16,0	0,0	10,0	4,0	0,0	2,0	0,0	0,0	0,0	0,0	0,0	0,0	0,0	0,0	0,0	0,0
	Planned Year 1	33,5			0,0			2,0		11,5	7,5	8,0		2,0		2,0			0,5										
	Planned Year 2	98,5			25,0			13,0		21,0	15,0	10,0		8,0		3,0			0,5										
	Planned Year 3	101,0			25,0			15,0		23,0	15,0	10,0		6,0		5,0			1,0										
WP8 cumulative planned		233,0	0,0	0,0	50,0	0,0	0,0	30,0	0,0	55,5	37,5	28,0	0,0	16,0	0,0	10,0	4,0	0,0	2,0	0,0	0,0	0,0	0,0	0,0	0,0	0,0	0,0	0,0	0,0
Work package 9: <5b - Reliability 650V @400A SIC>	WP9 total acc to Annex-1	175,0	0,0	0,0	60,0	0,0	0,0	0,0	0,0	0,0	0,0	0,0	0,0	53,0	0,0	0,0	55,0	0,0	0,0	7,0	0,0	0,0	0,0	0,0	0,0	0,0	0,0	0,0	0,0
	Planned Year 1	30,0			5,0									13,0			10,0			2,0									
	Planned Year 2	75,0			30,0									20,0			23,0			3,0									
	Planned Year 3	70,0			25,0									20,0			22,0			2,0									
WP9 cumulative planned		175,0	0,0	0,0	60,0	0,0	0,0	0,0	0,0	0,0	0,0	0,0	0,0	53,0	0,0	0,0	55,0	0,0	0,0	7,0	0,0	0,0	0,0	0,0	0,0	0,0	0,0	0,0	0,0
Work package 10: <6a - Avionics, Railway and Automotive IPS and others Demonstrators>	WP10 total acc to Annex-1	792,0	0,0	0,0	53,0	28,0	19,0	228,0	0,0	0,0	6,0	0,0	0,0	13,0	0,0	0,0	163,0	148,0	12,0	0,0	6,0	0,0	32,0	84,0	0,0	0,0	0,0	0,0	
	Planned Year 1	198,0			10,0	8,0	0,0	59,0						3,0			42,0	43,0	5,0				0,0	28,0					
	Planned																												

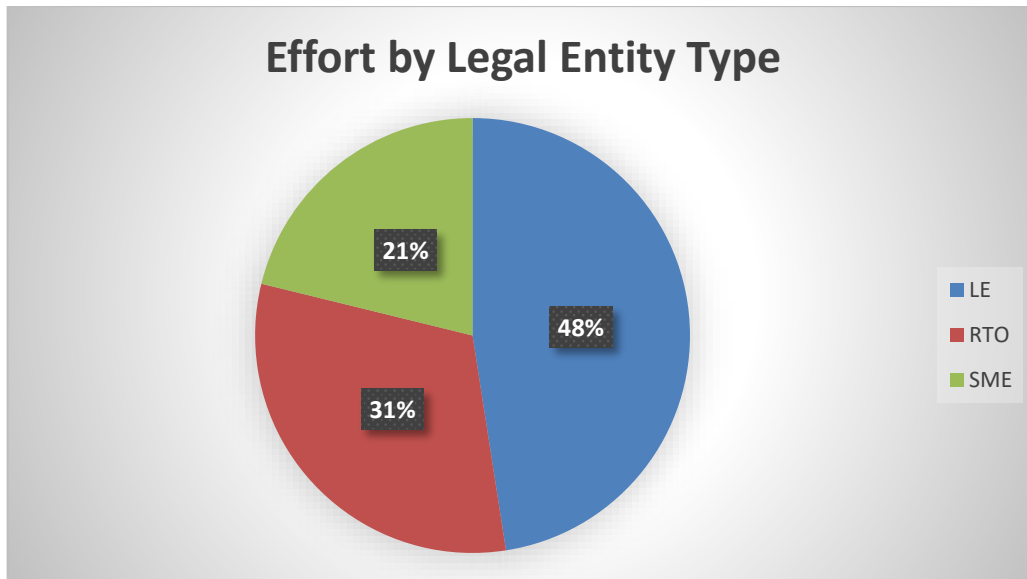

Figure 46 WInSiC4AP Effort by Legal Entity type

Table 3.4b: Other direct cost items (travel, equipment, other goods and services, large research infrastructure)

Please complete the table below for each participant if the sum of the costs for 'travel', 'equipment', and 'goods and services' exceeds 15% of the personnel costs for that participant (according to the budget table (JU Grant) in section 3 of the proposal administrative forms).

Participant 4 / NEXTER	Cost (€)	Justification
Travel	17000	Project Management: 2 Travels Specification IPS-AA : 2 Travels Specification IPS-RA : 2 Travels WP6 Management : 5 travels
Equipment	13000	Power Test Bench – Amortization (Estimated usage 110 days)
Other goods and services	140000	Mockup manufacturing EMC Test Laboratory Components failure analysis
Costs of large research infrastructure	40000	Support for IPS (Expertise, Defaults analysis, Model improvements)
Total	210000	

Participant 5 / VSCM	Cost (€)	Justification
Travel	15.500,00	
Equipment		
Other goods and services	337.360,00	prototype tool for housing prototype top cover soft tooling prototype bottom cover soft tooling Leadframe tooling connector tooling (power/signal) component procurement Boards manufacturing consumables programing means for FPGAµ controller Validation specific tooling (mechanical interfaces, sensors, in situ board testing, cabling...)
Total	352.860,00	

Participant 11 / ZODAERO	Cost (€)	Justification
Travel	61.200,00	2 travels per year in Europe, for 2 persons for 2 days, @ 1500€/travel.day.pers 6 travels per year in France, for 2 people for 1 day, @700€/travel.day.pers
Equipment	398.000,00	Test bench equipment Rapid prototyping platform Electronic boards layout & routing Electronic components for inverters demonstrators Mechanical components for inverters demonstrators Components for mock-up
Other goods and services	9.000,00	Software licence
Total	468.200,00	

Participant 12 / APOJEE	Cost (€)	Justification

Travel	24.000,00	2 travels per year in Europe, for 2 persons for 2 days, @1000€/travel.day.pers
	18.000,00	6 travels per year in France, for 2 people for 1 day, @500€/travel.day.pers
Equipment	455.470,00	Prototyping phase equipment Prototyping phase components Bench supervisor/real Time emulator Component for MARVEL Rack Bench Cabinet, Rack connectivity, Cooling circuit Bench PLC equipment
Other goods and services	15.530,00	Software License
Total	513.000,00	

Participant 13 / APSI3D	Cost (€)	Justification
Travel	24.000	Costs of travels related to project to meetings in Europe (4 meetings per year)
Equipment		
Other goods and services	300.000	Small tooling's 48K€, Purchasing of CEA R&D 120K€, Purchasing of components 80K€, Primes equipment rent for conformity and characterization 16K€, communication & dissemination 10K€, others 26K€
Total	324.000	

Participant 18 / ED	Cost (€)	Justification
Travel	10.000	That costs are related to travels for the activity of developing, testing and validating of the prototype and participation in project and consortium meeting. The Test phase is intended at laboratories as well as on field when the solution will be integrated in a demo installation
Equipment	55.000	Designing of e-charging infrastructure, Prototyping and type test at laboratories
Other goods and services	25.000	Audit service and dissemination activities, Support on the analysis of the marketable effective for the future use of the Bidirectional SiC-based Power Converter for V2G/V2H applications, ready for a successful industrialization.
Total	90.000	

Participant 16 / UNITOU	Cost (€)	Justification
Travel	17.000,00	project meetings 10000€ ; scientific dissemination events 7000€
Equipment		
Other goods and services	112.000,00	general consumables (measurement ends, probes...)35000€ ; clean room consumables (chemical products, gas, metals, targets...) 24000€ ; SiC substrates for test 14000€ ; recalibration of equipment that will be used for the project (Bench growth, test bench , AFM, optical or electronic microscopy ..) 27000€ ; modelisation/simulation tools (licence Matlab, COMSOL, PSpice) 12000€
Total	129.000,00	

Participant 17 / IMA	Cost (€)	Justification
Travel	12.000,00	Average 2 persons participating on 6 meetings, 1kE costs on one meeting per person
Equipment		
Other goods and services	5.000,00	Electronic components, Printed circuit boards, diagnostic tools, uController development boards, device casing, mechanical works and other material for prototyping
Total	17.000,00	

Table 3.4c: Support through ESI Funds

Participant Number/ Short Name	Managing Authority	Implementing Authority	Direct personnel costs/€	Other direct costs/€	Direct costs of subcontracting/ €	Indirect Costs /€	Total Eligible Costs relative to the ESI Funding (€)	Requested ESI Funding (€)
1 / DTSMNS	MIUR	MIUR	660.000,00	20.000,00	0,00	170.000,00	850.000,00	552.500,00
2 / ST-I	MIUR	MIUR	2.586.880,00	3.000.000,00	0,00	1.396.720,00	6.983.600,00	2.444.260,00
3 / UNICT	MIUR	MIUR	584.000,00	80.000,00	0,00	166.000,00	830.000,00	539.500,00
7 / UNIME	MIUR	MIUR	595.000,00	85.000,00	0,00	170.000,00	850.000,00	552.500,00
10 / CNR	MIUR	MIUR	526.500,00	73.500,00	0,00	150.000,00	750.000,00	487.500,00
14 / SAT	MIUR	MIUR	185.000,00	205.000,00	15.000,00	97.500,00	502.500,00	276.375,00
19 / SOFT	MIUR	MIUR	480.000,00	12.000,00	30.000,00	123.000,00	645.000,00	290.250,00
20 / DAC	MIUR	MIUR	1.065.120,00	362.000,00	170.000,00	356.780,00	1.953.900,00	1.074.645,00
TOTAL							13.365.000,00	6.217.530,00

Participant Number/Short Name	Cost (€)	Justification
2/ ST-I		
Travel	0	
Equipment	2.800.000 (*)	New equipment needs for SiC devices: SiC EPI Reactor, Trench etch for SiC, laser annealing
Other goods and services	200.000	SiC substrates
Total	3.000.000	

(*) Eligible cost based on equipment depreciation

Participant Number/Short Name	Cost (€)	Justification
14 / SAT SRL		
Travel	0	
Equipment	185.000,00	Equipment useful to the realization of prototypes
Other goods and services	20.000,00	Goods useful to the realization of prototypes
Total	205.000,00	

Participant 20/DAC	Cost (€)	Justification
Travel	32.000,00	Average 2 persons participating on 6 two-day meetings plus 2 person participating in the 10 dissemination events, 1k€ costs on one two-day meeting per person
Equipment		
Other goods and services	325.000,00	Electronic components, Printed circuit boards, diagnostic tools, Controller development boards, device casing, mechanical works and other material for prototyping
	5.000,00	Administrative costs for financial audits
Total	362.000,00	

Section 4: Members of the consortium

4.1. Participants (applicants)

Here below tables with description of legal entity followed by the list of the relevant publications of the Consortium.

Table 1: Legal Entity Tables

PARTNER N. 1 DISTRETTO TECNOLOGICO SICILIA MICRO E NANOSISTEMI S.C.A.R.L. (DTSMNS)	
<u>Role in the Project</u>	<i>Within the scientific scope of WInSiC4AP Project, DTSMNS is in charge of the Project Co-ordination, Project Management and it is participating with many teams principally covering from R&D. The DTSMNS is also involved in in the Communication & Dissemination, Exploitation, Standardization activities for Avionics and engine control..</i>
Organization Description	<p>The Technological District Sicily Micro and Nano Systems of Sicily is a consortium included into the 25 districts promoted by the Italian Ministry of Education & Research.</p> <p>The members of the District are the Region of Sicily, 3 Sicilian Universities (Palermo, Catania and Messina), the Italian National Research Council, research centers and development enterprises of the territory (SMEs and large companies). As a matter of fact, the Consortium owns really strong competencies, due to the fact that among its parties it includes several national and global firms dedicated to research, development and experimentation of micro-nano industrial systems.</p> <p>In particular, the District, in the priority sector of nanotechnology , focuses the activities on micro and nano systems able to introduce radical innovations, with specific and wide impacts in the following areas:</p> <ul style="list-style-type: none"> • micro and nano systems for Energy and Energy Efficiency; • micro and nano systems for human Health and Biotechnologies; • micro and nano systems for the Agrofood System; • micro and nano systems for Transports and Advanced Logistics Systems. <p>As part of the programming period 2007-2013, Technological District Sicily Micro and Nano Systems implemented, as project leader, important national cutting-edge projects about nanotechnology in the areas of health, energy and plastic materials.</p> <p>It is also member of two Italian Technology Clusters: Life Sciences - ALISEI - and the Smart Factory.</p> <p>Due to the fact that it is an innovative and representative cluster of centers of excellence of the Sicily Region, the District would like to promote itself as partner for cooperation projects and collaborations inside European networks in order to:</p> <ul style="list-style-type: none"> • facilitate investments in research, new technologies and innovation (in particular in the following areas: nanoelectronics, photonics, nanotechnology, biotechnology, advanced materials and advanced manufacturing systems); • promote the adoption of innovative solutions in companies and public administration; • facilitate internationalization processes, improving the ability to attract investments and talents, creating the conditions for the birth of start-ups and research spin-offs,

	<p>with the aim of achieving a better international competitiveness, and a better ability to achieve synergies between different industries of the same technological nature.</p> <p>In addition, the District intends to develop networks and projects in the specific field of electronics and in particular microsystems (CSA ICT-31-2017) and <i>Smart Anything Everywhere</i> - SAE (ICT-04-2017).</p>
Key personnel involved	<p>Project Coordinator, ing. Leoluca Liggio (male), received the master degree in Engineering in 1981. For about thirty years working in IBM as consultant and project manager, he built his competencies in the areas of project design & development, marketing, people management, client relationship. During his career in IBM he covered important and strategic roles, and closed his career in IBM as Manager in charge of the IBM Palermo branch. He can claim specific expertise in organization and management of complex teams, a strong competency in stakeholder management, risks and problem solving at the second level (e.g. steering committee). He also has expertise in the design and in the implementation of transformation plans and transition plans including the aspects of change management and people behaviour. After the IBM experience he worked for the KPMG Advisory Company, in Poland. During the four years of experience in to the DTSMNS he dealt with full success some complex R&D projects funded by MIUR on the National program (PON). He also owns a consultant CMC certification issued by the International Council of Management Consulting Institutes (ICMCI).</p> <p>Ing. Salvatore Frisella (male), in 1982 Degree in Engineering (cum Laude). For about twenty five years working in IBM, he built his competencies in the areas of project design and project development. Closed his career in IBM as Manager in charge after covered many important and strategic roles. He has been certified as Project Management Professional (PMP)® issued by Project manager Institute (PMI) and also as been certified as Certified Management Consultant (CMC) issued by the International Council of Management Consulting Institutes (ICMCI). During his experience IBM has gained much experience in project and risk, management having managed many complex projects. After the IBM experience he worked for the University of Palermo (Italy) as project manager. At present works in DTSMNS as project manager and has successfully managedt some complex R&D projects funded by MIUR on the National program (PON).</p>
Relevant previous projects and activities involvement	<p>As part of the <i>Strategic Development Plan 2011-2017</i>, DTSMNS has identified some “research/development & training”. Following 3 projects that were funded by the Ministry of University and Research:</p> <ol style="list-style-type: none"> 1) <i>PLAST_Ics - Electronics on Plastic Disposable Smart Systems</i> (R&D 10,74 Mio € - Education 1,4 Mio €) 2) <i>ENERGETIC - Technologies for Energy and Energy Efficiency</i> (R&D 16,74 Mio € - Education 1,9 Mio €) 3) <i>HYPPOCRATES - Development of Human Health</i> (R&D 20,23 Mio € - Education 1,85 Mio €).
Significant infrastructure and/or any major items of technical equipment, relevant to the proposed work	<p>The DTSMNS has, through its members, an important and advanced system of laboratories and research facilities and a strategic asset that provides and enhances system, with a view of the network:</p> <ul style="list-style-type: none"> ▪ more than 60 high-tech research laboratories from the three Sicilian universities and the National Research Council; ▪ more than 12 international research centers and high-tech industrial production put on by the team network industries (STMicroelectronics, IBM, SIFI, ENG, Corvallis, Italtel); ▪ a computer cluster of HPC provided by the COMETA consortium;

	<ul style="list-style-type: none">▪ over 11 industrial research labs and consortia made available by the Scientific and Technological Park of Sicily;▪ a network of universities, associated within the National Institute Biosystems and Biostructures.
--	---

PARTNER N. 2 STMICROELECTRONICS (ST-I)	
<u>Role in the Project</u>	<p><i>Within the scientific scope of WInSiC4AP Project, ST is in charge of the Project Co-ordination and it is participating with many teams principally covering from R&D front end to package to System Application.</i></p> <p><i>STMicroelectronics will supply chips and modules for the demonstrators, developing needed technologies for breakthrough at application level.</i></p>
Organization Description	<p>STMicroelectronics is a global independent semiconductor company developing and delivering semiconductor solutions across the spectrum of microelectronics applications. A combination of silicon and system expertise, manufacturing know-how and Intellectual Property (IP) portfolio positions the Company at the forefront of System-on-Chip (SoC) technology.</p> <p>In 2015, ST's net revenues were US\$ 6.9 billion and ranked among the top ten manufacturers of the microelectronics domain. ST designs, develops, produces and commercializes a large variety of semiconductors.</p> <p>ST is the world's leading supplier of EEPROM, analog automotive and thyristors, and holds challenging positions for MCU32 microcontrollers, sensors and actuators, rectifiers and power diodes, digital automotive, Analog data processing and analog industrial.</p> <p>In application segments, ST holds strong positions in Industrial and in Automotive. The group totals more than 43,000 employees, among which 8,700 working in R&D and product design; 11 main manufacturing sites and 75 sales offices in 35 countries.</p> <p>Among the several Facilities, STMicroelectronics Sites in Catania and Tours are Competence Center for POWER Domain. Today Catania hosts a pilot line for SiC in 4" that will be soon updated at 6".</p>
Key personnel involved	<p>Project Technical Coordinator: Ing. Antonio Imbruglia (male) received the master degree in Electronic Engineering from the University of Palermo (Italy) in 1983, and is working for STMicroelectronics Catania since 1984. He has experience in the semiconductor industry and in design, research and development for semiconductor integrated circuits for industrial applications (from 1984 to 1998). R&D developments for CERN and space applications (from 1999 to 2013).</p> <p>He holds patents in US and has coauthored two books on microelectronics. He also contributed to European and National research funded projects for space applications with ESA and supported European Component Initiative (ECI) developments.</p> <p>Present activity: ADG Group R&D, Power and Discrete FE&BE Technologies coordinator of European and National research funded projects for power electronics with EC, MIUR and Distretto Tecnologico Sicilia Micro e Nano Sistemi.</p> <p>Angelo Alberto Messina, Ph.D. (male) was graduated with a long <i>Electronics Engineer</i> Degree in 1997 from the University of Catania and after he got his Ph.D. in "Advanced Technologies for the Photonics and the Opto-electronics and Electromagnetic Modeling" from the University of Messina where he worked four years in the research team of the "Physics of Matter and Electronic Engineer" Department. Since 1999 he works in STMicroelectronics, being Program Manager of several EU Funded Project, working now in the "R&D and Public Affairs for Italy" Department.</p> <p>Mario Saggio (male) Mario Giuseppe Saggio, physics degree at Catania University. From 1993 to 1995 he was with CNR IMETEM involved with application of computer simulation to process and device engineering in Microelectronics. In 1995 he was with FhG-IIS B in</p>

	<p>Erlangen (Germany) in the frame of the European program Human Capital and Mobility. From December 1995 he is with R&D department of STMicroelectronics in Catania. He leads Silicon Carbide power devices design team and he is also involved in technology development for Silicon and Silicon Carbide devices. He has authored or coauthored over 40 papers in journals and conference and holds 30 patents.</p> <p>Emanuele Scrofani (male) Emanuele Scrofani, degree on Electronic Engineering at Catania University on July 1991 discussing a thesis of telecommunications domain on Integrated Metropolitan Area Network, officer in the Italian Technical Army Corp from January 1992 to April 1993 with assignment for 1 year to Calculation Center of Spermental Launching Base of “Salto di Quirra” in Sardinia. Hired in STMicroelectronics (Catania site) on September 1993 inside Power Transistors Product Engineering with different missions in Morocco (resident for 1 year during 1996) and China Back End plants, from July 2007 responsible of Catania Package Engineering & Development Group, leading inside R&D department the Power Packaging Development and Engineering activities for Discrete packages, Intelligent Power Modules and Hi End Power Modules.</p>
<p>Relevant previous projects and activities involvement</p>	<p>Project Last Power [GA no 120218, ENIAC] “Large Area silicon carbide Substrates and heteroepitaxial GaN for POWER device applications”. The Last Power Project aims to make EU independent from other developed countries on wide band gap semiconductor high quality material, equipment and advanced processing (2010-2014, www.eniac-lastpower.org).</p> <p>Ambition Power [National Project PON01_00700] The project has the overall objective to develop the technologies and power modules for enabling applications that are characterized by high performance in terms of energy efficiency. (2010-2014, www.ambitionpower.org)</p> <p>ENERGETIC [National Project PON] “Tecnologie per l'ENERGIA e l'Efficienza energETICa”. The ENERGETIC project addresses technology issues of photovoltaic systems and energy efficiency with a broad approach on issues concerning materials, devices, and ICT. (2012-2015, www.distrettomicronano.it/drupal/it/content/progetto-energetic)</p>
<p>Significant infrastructure and/or any major items of technical equipment, relevant to the proposed work</p>	<ul style="list-style-type: none"> - 4” SiC Pilot Line including Epitaxy internal process - Power Module Product Line - Quality Laboratory full equipped - Application Laboratory with test bench for converter up to 100kW

PARTNER N. 3 UNIVERSITA' DEGLI STUDI DI CATANIA (UNICT)	
<p><u>Role in the Project</u></p>	<p><i>UNICT will contribute mainly to the following activities:</i></p> <p><i>WP2a: optimization of energy conversion addressing the converter stages of Tasks 2a.1, 2a.2, 2a.3, 2a.4. All activities will be carried out in collaboration of the UNIME Power Electronics group.</i></p> <p><i>UNICT will also address EMI issues in the power converters in Task 2a.6. Finally, UNICT, will also be involved in the definition of the specifications for the intelligent power switch for the Avionics, Railway and Automotive IPS Demonstrators.</i></p> <p><i>WP3a: Task 3a.4 design of integrated magnetic components for both power converters and EMI filters. Finite Element Analysis (FEA) software will be used to design the magnetic components in order to define the structure and geometrical properties.</i></p> <p><i>WP5b: Task 5b.1 evaluation of integrated magnetic components in terms of characteristics and parasitic components. The EMC facilities of the UNICT will be used to characterize the developed magnetic components, also using such devices in reference design converters.</i></p> <p><i>WP6a: Task 6a.1 and 6a.3 – 6a.6 UNICT will collaborate to the test of the converters for the addressed applications. For this WP, UNICT will also develop machine-learning software approaches for energy management optimization by minimizing power loss in multi-power-source systems, especially, in case of load demand fluctuation and intermittence. Such techniques will be tested on the three discussed demonstrators (Avionics, Railway and Automotive).</i></p> <p><i>WP6b: Task 6b.1 and 6b.2 UNICT will collaborate to the design and test of the converters for the addressed applications.</i></p> <p><i>WP7: strong commitment to dissemination, mainly with conference participation.</i></p>
<p>Organization Description</p>	<p>The University of Catania is one of the oldest academic institution in Italy with 18 Departments and an university center for outstanding students, The Scuola Superiore of Catania a School of Excellence. The research institution of UNICT working within the project is the Department of Electrical and Electronics Engineering and Informatics (DIEEI).</p> <p>The scientific groups working at the Department of Electrical and Electronics Engineering and Informatics (DIEEI) of the University of Catania have been active since 1971 in the sectors of Electrical and Electronic Engineering, Systems, Automation, Informatics and Telecommunications. The Department carries out its institutional activities within the territory of eastern Sicily, but with strong scientific links with other Italian and foreign universities and cooperative relationships with industries and public institutions (Fiat, Ansaldo, CNR, ENEA, TIM). Among the collaborations, particularly important is that with various groups within STMicroelectronics. The Department operates in an international context, from the relationships that each researchers have woven over the years, which allows to carry out research activities aligned with those developed in the best engineering schools and train young researchers with significant experience abroad. They are conducted using the experimental facilities of the Department and are developed on the basis of modern and competitive strategies, with results of high scientific value, witnessed by national and international awards. The Department includes several laboratories, including that of Power Electronics, Electrical Machines and Drives, that of Microelectronics, the Electrical Measures and Electronic Equipment, the Automation and Systems, all equipped with machines, equipment and measuring instruments and advanced calculation, allowing the realization of experimental research.</p> <p>The Electrical Machines and Power Electronics Group (EMPEG) of the Department of Electrical Electronic and Computer Engineering includes 5 full time scientists with 4 Professors and 1 Post-Graduate, 5 technicians and administrators, and several Ph.D. and graduate students. Since 1975 the research activities are devoted to Power Electronics and Energy conversion systems, dealing with power electronic converters and devices, electrical machines and drives, and their application in industrial</p>

	<p>processes, energy conversion from renewables, automotive and traction applications, home appliances.</p> <p>The Pattern Recognition and Machine Learning group (PeRCeiVe) at the Department of Electrical Electronic and Computer Engineering consists of one full professor, one associate professor, one assistant professor, and several research assistants and PhD students. The Pattern Recognition and Computer Vision group is actively involved in pursuing cutting edge research on issues related to Machine Learning and Pattern Recognition and their application to real-world problems including intelligent energy management optimization in multi-power-source systems.</p>
<p>Key personnel involved</p>	<p>Prof. Ing. Mario Cacciato, PhD (male) received the M.S. degree in electrical engineering (cum laude) from the University of Catania, Italy, in 1996 and the Ph.D. degree in electronic engineering from the University of Reggio Calabria, Italy, in 2000. In the same year, he became Assistant Professor at the Department of Electrical Engineering, University of Rome “La Sapienza,” Italy. In 2004, he was with the Department of Electrical, Electronics and Computer Engineering, University of Catania. From 2011 he is Associate Professor at the Dept. of Electrical and Electronic Engineering and Computer Science, Univ. of Catania, where is currently teaching Electrical Machines and Energy Conversion from Renewable Sources. He is the author of more than 120 technical papers, published on journals and proceedings of international conferences. His main scientific interests include power electronics, control of electric drives, electromagnetic compatibility, renewable energies, and power devices. He has been the coordinator for the UNICT research group of several EU and national projects funded by ENIAC JU, Italian MIUR and others.</p> <p>Prof. Cacciato is a member of IEEE and EPE (European Power Electronics Association) where is serve as a member of the EPE Executive Council. Since 2011 he chairs the EPE Chapter on Solar Energy.</p> <p>Prof. Ing. Giuseppe Scarcella, PhD (male)</p> <p>He received the M.S. and Ph.D. degrees both in electrical engineering from the University of Catania, Catania, Italy, respectively in 1995 and 1999. In 1995, he was the recipient of an SGS Thomson (now STMicroelectronics) Research Grant. In 1998, he spent a period at the University of Wisconsin, Madison, working on sensorless control of electrical drives. In 1999, he joined the Department of Electrical, Electronic, and Systems Engineering, University of Catania, as temporary researcher. In 2001, he obtained a permanent position as Assistant Professor, in the same department, where, since 2005, he is currently an Associate Professor in the areas of power electronics, electrical machines and drives. He is the author of over 130 technical papers published on journals and proceedings of national and international conferences and holds several international patents. He was the recipient of a Third Prize Paper presented at the IEEE Industry Applications Society (IAS) Annual Meeting in 1998 and of an Award for the Best Paper published in the IEEE Transactions on Power Electronics in 2000. He is currently serving as Associate Editor in IEEE Transactions on Industry Applications. His current research interests include: sensorless control of electrical machines, advanced control, digital modulation techniques, efficiency optimization techniques and electromagnetic compatibility. Prof. Scarcella is a member of the IEEE Industry Applications Society.</p> <p>Dott.Ing. Giacomo Scelba, PhD (male)</p> <p>He received the M.S. and Ph.D. degrees in Electrical Engineering from the University of Catania, Catania, Italy, in 2002 and 2005, respectively. He is currently an Assistant Professor at the Department of Electrical and Electronic Engineering and Computer Science, University of Catania. His current research interests include sensorless control, digital signal processing, ac drive control technologies, fault tolerant control solutions devoted to multiphase and multidrive AC systems and control techniques for renewable energy systems. Prof. Scelba is a Registered Professional Engineer in Italy</p>

	<p>and is a member of the IEEE Industry Applications, the IEEE Industrial Electronics and the IEEE Power Electronics Societies.</p> <p>Prof.Ing. Alberto Faro (male) received the Laurea degree in nuclear engineering from Politecnico of Milan. Since 1986 he is full professor of Information Systems and Artificial Intelligence at the University of Catania. Prof. Faro was one of the founders of the Department of Informatics and Telecommunication Engineering. Also, he has served, for many years, as the Dean of the Graduate Programs in Electronics Engineering and in Computer Engineering at the same University. He has published over 200 scientific articles in fields such as computer networks, system engineering and distributed systems. His current research interests include knowledge discovery from heterogeneous data, cyber-physical systems for smart applications, and mobility information systems.</p> <p>Prof.Ing. Daniela Giordano, PhD (female) holds a Laurea degree in Electronic Engineering, grade 110/110 cum laude, from the University of Catania, (1990), and a Ph.D. in Educational Technology from Concordia University, Montreal (1998). For her PhD work dealing with a content sharing system for learning analysis and design skills she received the Prix d'excellence du CIPTÉ - Canada for the best doctoral thesis in Educational Technology (1997-1998). Since 2001 she has been associate professor of Information System Design and Human Computer Interaction at the University of Catania. Prof. Giordano has published over 150 scientific articles reflecting highly interdisciplinary research and international collaborations. She has been involved as principal investigator in a number of EU, national and regional projects, ranging in the fields of data and ontology engineering, knowledge based systems for smart cities and automotive, automated image and video processing.</p> <p>Dr. Ing. Concetto Spampinato, PhD (male) received in 2003 the Laurea degree, grade 110/110 cum laude, and the PhD in Computer Engineering from University of Catania in 2008 where, currently, he is an assistant professor. He has worked actively on machine learning and pattern recognition in disparate real-world applications. He has published a few books and over 100 articles in international refereed ISI journals and peer-reviewed conference proceedings. His main interests involve computer vision, machine learning for intelligent data analysis and integration in smart cities and automotive application domains.</p>
<p>Relevant previous projects and activities involvement</p>	<p>The UNICT research group has participated to several research project focused on WBG. In particular, the contributions were on application, addressing the electronic power conversion stages both in term of the study and development of new converter topologies and the optimization of magnetic passive components. Another relevant issue is the study and development of integrated magnetic components for EMI filters where the parasitic capacitance of the PCB layers and the windings of magnetics have been used as part of the filter itself. This last topic has been exploited in the project E2SG Energy to Smart Grid (coordinated by Infineon). The E2SG project is recently concluded and it has received the ECSEL Innovation Award 2015.</p> <p>The UNICT group has participated in several EU and national projects which present synergies with this proposal:</p> <ul style="list-style-type: none"> · ENIAC JU/CALL 2010/270722-2 ERG "Energy For A Green Society: From Sustainable Harvesting To Smart Distribution. Equipments, Materials, Design (Participant) · ENIAC JU/CALL 2011-1/296131 E2SG "Energy to smart grid" (Participant) · Italian MIUR PON R&C 2007-2013 PON01_00700 "Ambition power" (Participant) · Italian MIUR PON R&C 2007-2013 PON02_00355_3391233 "Energetic" (Participant) <p>Some of the above projects target mainly Si and GaN power devices and technologies but objectives were different respect to WInSiC4AP.</p>

Significant infrastructure and/or any major items of technical equipment, relevant to the proposed work	The Department includes several laboratories, including that of Power Electronics, Electrical Machines and Drives, that of Microelectronics, the Electrical Measures and Electronic Equipment, the Automation and Systems, all equipped with machines, equipment and measuring instruments and advanced calculation, allowing the realization of experimental research. In particular, DIEEI has an anechoic chamber and several equipment for EMC/EMI measurements.
---	--

PARTNER N. 4 NEXTER Electronics (NEXTER)	
<u>Role in the Project</u>	<p><i>NEXTER will drive the technology developments and demonstrators targeting “dual technology” having the capability to address different markets. In the domain of WInSiC4AP project contribution is planned on :</i></p> <ul style="list-style-type: none"> • <i>WP2- Requirements and Use Case Definition, for Intelligent Power Switch used on aero terrestrial platforms (Task 2.a3)</i> • <i>WP6 - Demonstrators</i> <ul style="list-style-type: none"> ○ <i>Lead the WP</i> ○ <i>Proceed on relevant Tasks as Leader :</i> <ul style="list-style-type: none"> ▪ <i>6.a1 : Intelligent Power Switch for Avionics</i> ▪ <i>6.a6 : Intelligent Power Switch for Railway</i>
Organization Description	<p>NE is a subsidiary of NEXTER group, located in Toulouse in southern France. The aim of NE is to supply, maintain & upgrade on-board electronic equipment’s working in harsh environments & integrated in long life cycle systems, for military and civilian fields. The main technical sectors where NE is involved in:</p> <ul style="list-style-type: none"> • MMI and data processing, • Command and Control for actuators and sensors, • Energy management and distribution. <p>The main civilian & military programs involvement in terrestrial and aeronautical fields are: Leclerc, VBCI, Caesar, Auf1, Vab, ... Tigre, Rafale, Falcon, Saab2000, Transal, A340, A350 etc.</p> <p>The most important R&D effort is realized on Energy Management & Distribution solutions. WInSiC4AP project is directly in accordance with this R&D effort.</p> <p><u>NE key figures:</u></p> <ul style="list-style-type: none"> • A turnover of 25...30 million Euros / Year • 110 employees including 75 engineers and executives (31/12/2015) • 100 projects performed by year • Investment in R&D : 10% of revenues
Key personnel involved	<p>Jose Domingo Salvany (male): Senior industrial engineer with an MSc degree on Power Electronics from the Barcelona University (1975), a MSc degree on biomedical engineering for University of Toulouse III (1977), and MSc in Materials & Active components for University of Toulouse III (1978), he has done a PhD Thesis in biomedical engineering, focused in anti-biogram (1981). Over 10 years involved on advanced studies at European level. NE leader for WInSiC4AP Project.</p> <p>Herve Gras (male): Senior industrial engineer with a MSc degree on Physics from the Lyon University (1986). He works on electronics components industrial manufacturing process over 2003. Works on methods to manufacturing at DTC the electronic equipment’s for defence over 2006. In 2007 became project manager for manufacturing Leclerc MBT equipment’s. Since 2009 is project manager of upstream studies. He takes the management of WInSiC4AP project.</p> <p>Phillipe Decroux (male): Power Electronics & Control Engineer, with a Master of Sciences from Toulouse University (1995), works on development of Power Modules for Power Management & Distribution embedded on dual application. In WInSiC4AP, he takes the responsibility of demonstrator’s specifications manufacturing and validation.</p> <ul style="list-style-type: none"> • EDA WS – Power Sources (10/2013) : Advanced power networks topologies to improve electrical energy efficiency on land military platforms

	<p>Nabil Boukari (male): Power Electronics engineer with a MSc on Power Electronics from Toulouse University (2002), works on development of Power Converters & Inverters devoted to embedded applications for dual-use. In WInSiC4AP, he takes the responsibility of specifications and validation for new IPS components.</p> <ul style="list-style-type: none"> • MsC Thesis (2000): Modélisation du mouvement à l'aide de codes de calcul par éléments finis en 3D : application à la machine homopolaire et au microactionneur électrostatique. • MEA (11/2012) : Solid State Power Controller (SSPC) for protection of continuous embedded network.
<p>Relevant previous projects and activities involvement</p>	<p>On the last 10 years, NE was involved in several projects ad national or European level :</p> <ul style="list-style-type: none"> • National (FR): “DIAMONIX” (Switches based Diamond), • National (FR): “RECUPENER” (Energy recovery in aeronautical functions using Solid State Power Controllers working in High Voltage Direct Current). • National (FR): “NOMAD” (electric machine density: low speed, high torque), • National (FR): “SUPERNOMA” (battery hybridization with super capacitors). • National (FR): “CORAC / GENOME” (HVDC – Local Power Network for aerospace actuators). • European (CLEANSKY): “Actuation 2015” (Power Control Module for Actuators)
<p>Significant infrastructure and/or any major items of technical equipment, relevant to the proposed work</p>	<p>REX (Return of experience) on the use of MOSFET SiC : SSPC modules in discrete form, Inverter modules. Test bench & rigs (100 kW) to evaluate new technologies for HVDC power networks (up to 1kV DC), used in military, aeronautics, and railway applications.</p>

PARTNER N. 5 VALEO SYSTEMS DE CONTROLE MOTEUR SAS (VSCM)	
<p><u>Role in the Project</u></p>	<p><i>In WINSIC4AP project, VSCM will propose the development of 2 demonstrators, on DCDC converter and one On Board charger. These 2 products are focused on energy conversion for electric or hybrids vehicles, for which high improvement of size, cost and efficiency are required in next generation.</i></p> <p><i>A part of the VSCM work will be done on WP2 for demonstrator specification, and their use case definition (for tests, validation and reliability purpose). VSCM is responsible of 2 tasks (for each demonstrator) and will coordinate the complete workpackage.</i></p> <p><i>Main activity of VSCM will take place in WP6 for the demonstrator development, as VSCM is a end user of the supply chain. VSCM will be responsible of 2 tasks, one for each demonstrator.</i></p> <p><i>Target of these new products will be focused on efficiency optimization, size reduction and a design to cost approach. Both products developed are constituted by switches, magnetic components (transformers and inductors) and local energy storage (capacitors). We have detected that SiC technology for switches could be of high benefits and will have a positive impact for each of these 3 axes. But using these components requires an adapted power electronic topology in order to be able to take full benefits from this new component technology.</i></p> <p><i>ST will be a key partner in WinSiC4AP project for VSCM as they will provide the SiC technology for these new components (switches). APSI3D could also be implicated if their technology for die packaging is relevant for one of the 2 demonstrators (a feasibility study will confirm this point). For automotive applications in general and in electric vehicle in particular, the reliability and the mastering of failure mode is mandatory. WÜRTH will also provide important work for passive component technologies design (capacitors, magnetic component design and PCBs technologies). New technologies won't be introduced on the market without a clear statement and validation of reliability. WP5 will focus on this item and the results are a key lever for the output of the project and its impact. For modeling and simulation, WÜRTH will give his support. Functional test and final endurance tests will be done in collaboration with APOJEE.</i></p> <p><i>Key words: On Board Chargers (OBC), DCDC HV-LV isolated converters, SiC switches, passive components size reduction, mechatronic integration, efficiency, affordable cost.</i></p>
<p>Organization Description</p>	<p>VSCM is an independent group, fully focused on the design, production and sale of components, integrated systems and modules for the automobile industry, mainly for the reduction of CO2 emissions. It is one of the world's leading automotive suppliers. VSCM is a first tier automotive parts supplier with a worldwide foot print. Investment in Research & Development represents 10% of the Group's total operating revenues for line fit products.</p> <p>Valeo Engine and Motor control Systems (VSCM) is a subsidiary of Valeo and is focused on the design, manufacturing and sales of electrical systems for powertrain systems.</p> <p>In last decade VSCM has also developed a complete hybridization strategy starting from micro hybrids up to electrical vehicles. VSCM has introduced the "stop start" system on the belt driven Starter alternator reversible system with PSA in 2004, is now focused on implement new functions regenerative braking and torque assist to design cost effective mild hybrid solutions. In the same time VSCM is working on electrical vehicles and derivative solutions (full hybrids and plug in hybrids).</p>

	<p>VSCM has a great experience in electrical cars (background from Sagem) providing to Renault and PSA electrical power train systems covering all power electronics components needed in the system: DCDC HV-LV converter, inverter, on board charger, and associated vehicle supervisor. These vehicles were sold from 1998 to 2005.</p> <p>As from 2008, Valeo has empowered the developments links to hybrids and Full electric vehicles power electronics. In 2013, Valeo acquired also Eltek company located in Norway in order to enlarge its portfolio to on board charger products. We are now able to propose to customers a full proposal on the complete range of hybrids and pure electric vehicles: inverters are in mass production with 2 major customers (US and French OEM), DCDC converter has started production in 2016, and on board chargers are already in production with the second generation (European and Chinese market).</p> <p>In order to develop our next generation products with the constant willingness to propose more efficient and cost oriented solution for affordable system, Valeo launched some major innovative projects in the last years. French funded programs like Sofraci and Memoire projects have boosted the innovations and Valeo is proud to be able to propose a new inverter concept and structure. This product is not yet on the market but concept phase is now validated. Valeo did also participate to THOR European funded project within Catrene organization, on a DCDC converter research. This DCDC was supported by the THOR project, and is in production since beginning of 2016 for US market.</p> <p>More recently, Valeo is involved in an important French program called MEGAN and participate to the evaluation of a very new technology of switches components from GaN technology. Valeo is also involved in 3Ccar European project for a high power (>200kW) inverter development.</p>
<p>Key personnel involved</p>	<p>Bénédicte Silvestre (female) Since 2008, Bénédicte is responsible for advanced R&D projects for power electronics in the field of Hybrid and Electric Vehicles, based in Cergy France. She is recognized as Valeo Senior expert in power electronics and mechatronic design. Before that, she has been three years in charge of advanced R&D projects for Engine control units product and electric motor drive product lines, including manufacturing processes and assembly technologies. From 2001 to 2005, she led power steering product line engineering in Johnson Controls Automotive Electronic. She started her carrier in 1994 as hardware designer then team leader in Electric Vehicle components team in SAGEM company, and developed charger, DCDC converter and inverter for PSA and Renault. She's got a diploma from engineering high school (ESIGELEC, Rouen, France) specialized in power electronics and electrotechnics, and a DEA (troisieme cycle diplome d'études avancées) in automatism, system controls and electric motor control laws.</p>
<p>Relevant previous projects and activities involvement</p>	<p>In order to develop our next generation products with the constant willingness to propose more efficient and cost oriented solution for affordable system, Valeo launched some major innovative projects in the last years. French funded programs like Sofraci and Memoire projects have boosted the innovations and Valeo is proud to be able to propose a new inverter concept and structure. This product is not yet on the market but concept phase is now validated. Valeo did also participate to THOR European funded project within Catrene organization, on a DCDC converter research. More recently, Valeo is involved in an important French program called MEGAN and participate to the evaluation of a very new technology of switches components from GaN technology. Valeo is also involved in 3Ccar european project for a high power (>200kW) inverter development.</p>

<p>Relevant patents</p>	<ul style="list-style-type: none"> • Gang Yang, Patrick Dubus, “Dispositif d’un nouveau transformateur résonant appliqué dans un convertisseur résonant LLC”, MFR0902, 04/2014 • Gang Yang, Patrick Dubus, “Procédé et dispositif de commande d’un convertisseur multi-phase courant continu-courant continu à résonance, et convertisseur multi-phase correspondant”, MFR0777, 04/2013 • H.SADKI, L. BENDANI, « Flyward+buck ou boost_pat », MFR1456219 • L. DE SOUSA, « FlyWard & Buckboost Combination », MFR1459951 • H.SADKI, P. DUBUS, G. YANG, L. BENDANI, “CONVERTISSEUR DE TENSION COMPRENANT UN CIRCUIT CONVERTISSEUR A RESONNANCE, MFR1456215 • H.SADKI, L. BENDANI, « CONVERTISSEUR DE TENSION COMPRENANT UN CIRCUIT CONVERTISSEUR DC/DC ISOLE », MFR1456219 • L. DE SOUSA, « Convertisseur de tension continue et procédé de commande associé » MFR1458573 • L. DE SOUSA, « VT Flyback-Forward with Acctive Rectifier 2”, MFR1459957 • L. BENDANI, « FlyWard & Boost command”, MFR1456226
--------------------------------	---

PARTNER N. 6 CONSORZIO NAZIONALE INTERUNIVERSITARIO PER LA NANOELETRONICA (IUNET)	
Role in the project	<p><i>IUNET will contribute to the activities on reliability of 1200-1700V SiC devices (WP5a) and will coordinate Task 5a.3 on failure analysis and physical modeling. Its key contributions will be in the following topics:</i></p> <ul style="list-style-type: none"> • <i>Performance evaluation and understanding of parasitic phenomena in Power SiC devices (trapping, gate leakage, drain leakage ...) in order to identify technological countermeasure;</i> • <i>Understanding breakdown phenomena and identification of the device Safe Operating Area;</i> • <i>2D / 3D simulations of Power SiC devices.</i> • <i>Identification of device failure modes and mechanisms for the development of a Robust and reliable Power SiC devices – based technology.</i> • <i>Identification of a suitable circuit topology so to as to better assess the power SiC device performance and robustness;</i> • <i>Realization of a test circuit capable of highlight the device performance in real operating conditions (hard-switching and soft-switching cases)</i> <p><i>IUNET will participate to the definition of the application requirements and to the implementation of intelligent power switches and portable EV battery chargers in WP2a and WP5a in collaboration with ED.</i></p> <p><i>IUNET will have a strong commitment to dissemination (WP7a).</i></p>
Organization description	<p>The “Consorzio Nazionale Interuniversitario per la Nanoelettronica” (IUNET, Italian Universities Nano-Electronics Team), is a non-profit, private Organization, which has been created with the initial aim to lead and coordinate the effort of the major Italian University Teams in the field of Semiconductor-Based Nanoelectronic Device Modeling and Characterization. After this initial phase, several other groups have joined IUNET, bringing competences in analog, mixed-mode and digital IC design, electronic systems, algorithms for signal processing and power devices based on III-V and III-N semiconductors.</p> <p>Current Members of IUNET are the Universities of Bologna, Calabria, Ferrara, Modena e Reggio Emilia, Padova, Pisa, Roma “Sapienza”, Udine, and the Politecnico of Milano. They offer renown and complementary expertise in the field of modeling, simulation, design, characterization of CMOS-based nanometer-size electronic devices as well as in the development of algorithms and architectures for signal and information processing and power generation.</p> <p>The partners of IUNET involved in the project are the following:</p> <ul style="list-style-type: none"> • Università di Bologna • Università della Calabria • Università di Padova. <p>The specific competences and expertise brought to the project are related to i) the understanding of parasitic phenomena in SiC-based Power devices, through: advanced characterization and device modeling and assessment of technological countermeasures, ii) 2D/3D device simulations of SiC-based devices with special focus on parasitic phenomena and breakdown behavior; iii) Identification of device failure modes and mechanisms and recommendations towards the development of a robust and reliable SiC–based technology. At a system level, IUNET will contribute to the development of system architectures such as SiC-based power converters, to the definition of specific requirements and to the drawing out of possible use cases. This contribution is relevant to the project and is certified by the very large number of relevant papers published in international journals, the long-standing collaboration with leading industries in the field and the extremely significant recognition at international level of all the involved team members, as it can be deduced by their CVs.</p>

<p>Key personnel involved</p>	<p>Susanna Reggiani (female) received her Ph.D degree in Electrical Engineering and Computer Science in 2001 from the University of Bologna. In 2012 she became Assistant Professor at the University of Bologna. She is currently in charge of two courses: “Electronics” for the Bachelor Degree in Electrical Engineering and “Solid-State Sensors” for the Master Degree in Electronic Engineering.</p> <p>She is currently a staff member of the research team coordinated by Prof. Giorgio Baccarani, where she is involved in research activities concerning the physics, modeling, design and characterization of advanced CMOS and beyond-CMOS transistors. More recently, she has been involved in the modeling and characterization of Smart Power devices. Her scientific activity has been devoted to the physics, modeling and characterization of electron devices, with special emphasis on transport models in semiconductors. Since 2007, she has been involved in projects funded by the American Semiconductor Research Corporation (SRC) in collaboration with Texas Instruments (Dallas, Texas), dealing with the modeling, design and TCAD analysis of power MOSFETs, modeling and characterization of hot-carrier stress degradation, modeling of package influences on high-voltage semiconductor FETs. She is currently involved as staff researcher in the European Project “Technology CAD for III-V Semiconductor-based MOSFETs (III-V-MOS)” on the development of physically-based mobility models for InGaAs channels accounting for the role of interface traps and strain. She is also involved as staff researcher in the European ENIAC JU Project "Energy Efficient Converters using GaN Power Devices (E2COGAN)” on the task devoted to the investigation of high-field carrier transport, impact-ionization generation and thermal behavior of GaN-on-Si heterostructures.</p> <p>Felice Crupi (male) received the M.S. degree in Electronic Engineering from the University of Messina in 1997 and the Ph.D. degree from the University of Firenze in 2001. Since 2002, he has been with the University of Calabria as an Associate Professor of Electronics. His main research interests include reliability of CMOS devices, modeling and simulation of CMOS devices, electrical characterization techniques for solid-state electronic devices, the design of ultra low noise electronic instrumentation and the design of extremely low power CMOS circuits. He has authored over 150 publications in peer-reviewed journals and in international conference proceedings. He served as a technical program committee member of International Electron Devices Meeting and International Reliability Physics Symposium. He is an Associate Editor of the IEEE Transactions on Device and Materials Reliability. Since 2015, he is the Coordinator of PhD in ICT at University of Calabria.</p> <p>Gaudenzio Meneghesso (male) is a Full Professor of Electronics at the University of Padova. He graduated in Electronics Engineering at the University of Padova in 1992 working on the failure mechanism induced by hot-electrons in MESFETs and HEMTs and received the Italian Telecom award for his thesis work. In 1997 he received the Ph.D. degree in Electrical and Telecommunication Engineering from the University of Padova working on hot-electron characterization, effects and reliability of GaAs-based and InP-based HEMT's and pseudomorphic HEMT's. His research interests are: i) Electrical characterization, modeling and reliability of power, microwave and optoelectronic devices on compound semiconductors; ii) Electrical characterization, modeling and reliability of RF-MEMS switches for reconfigurable antenna switches; iii) Study of the sensitivity of Electronics devices to Electrostatic discharge and development of suitable protection structures; and iv) Characterization and reliability of organic semiconductor devices. Within these activities he published more than 600 technical papers (of which more than 70 Invited Papers and 6 best paper awards). He is in the steering committee of several European conferences. He also served several years for the IEEE-International Electron Device Meeting (IEDM) and He is serving</p>
-------------------------------	--

	<p>in the Management committee of IEEE International Reliability Symposium (IRPS). He is Associate Editor of the IEEE Electron Device Letter for the compound semiconductor devices area since 2007.</p>
<p>Relevant previous projects and activities involvement</p>	<p>The IUNET Team has carried out and coordinated research on the physics of device behavior, reliability, failure mode analysis, and in the understanding of correlations between the material properties, the fabrication process and the operation and reliability of devices. Among the most distinctive research contributions of the IUNET Team there is a comprehensive study of the characterization, modeling and reliability physics of silicon and compound semiconductor devices (including GaN and SiC power devices), which identified new failure mechanisms relevant for device and circuit applications, leading to improved device processing and to the development of new techniques of device performance and reliability assessment. The approach used by the IUNET Team involves the use of accelerated testing including a detailed DC, pulsed and RF electrical characterization, coupled with nondestructive physical device characterization supported by 2D/3D TCAD modelling. The expertise of IUNET Team includes analysis, design and realization of power converters for different applications, ranging from the interface for renewable energy sources to intelligent inverters for smart grids. For the application tasks, the IUNET team has contributed to the project E2SG Energy to Smart Grid (coordinated by Infineon) devoted to the monitoring and control of smart grids. The E2SG project is recently concluded and it has received the ECSEL Innovation Award 2015. The group is (or has been) WP leader in several EU project :</p> <ul style="list-style-type: none"> • FP7 project: ALINWON “AlGaN and InAlN based microwave components”, coordinated by UMS, Germany (WP leader) • HIPOSWITCH “GaN-based normally-off high power switching transistor for efficient power converters”, Coordinate by FBH, Berlin (WP Leader) • E2COGAN (ENIAC-324280) - Energy Efficient Converters using GaN Power Devices (WP Leader) • ENIAC project END “Models, Solutions, Methods and Tools for Energy Aware Design” (Participant) • ENIAC JU/CALL 2010/270722-2 ERG “Energy For A Green Society: From Sustainable Harvesting To Smart Distribution. Equipments, Materials, Design (Participant) • ENIAC JU/CALL 2011-1/296131 E2SG "Energy to smart grid" (Participant) • Semiconductor Research Corporation - Global Research Collaboration - Contract n. 2011-VJ-2161 "Physically-based HCS Degradation Model for TCAD Analysis of Power MOSFETs" (Principal Investigator) • Semiconductor Research Corporation - Global Research Collaboration - Contract n. SRC 2012-KJ-2257 "Modeling of Package Influences on High-Voltage Semiconductor FETs" (Principal Investigator) <p>All the above projects target mainly Si and GaN power devices and technologies.</p>
<p>Significant infrastructure and/or any major items of technical equipment, relevant to the proposed work</p>	<p>The IUNET team is equipped with state of the art labs for the characterization and modeling of Power devices. Among others, here is a list of the major available characterization and simulations capabilities:</p> <p>Device characterization full equipped laboratory. Technology CAD and IC CAD capabilities.</p>

PARTNER N. 7 UNIVERSITA' DEGLI STUDI DI MESSINA (UNIME)	
<u>Role in the Project</u>	<p><i>UNIME will support ST-I in the analysis for Reliability and Failure Models. Reliability will be carried out by means canonical stresses, adding to those some equipment for specific application: UNIME will project and develop a dedicated equipment to assess the life time of modules.</i></p> <ul style="list-style-type: none"> • WP 3b High speed thermal mapping of power devices. • WP 3b Mapping of the mechanical stress on power devices. • WP 3b Optical, morphological and spectroscopic characterization also on the nanoscale. • WP 4 Reliability and lifetime estimation. • WP 7 Dissemination <p><i>UniME in collaboration with UniCT will also support VSCM, NEXTER and DAC in developing DC/DC and AC/DC power converters.</i></p> <ul style="list-style-type: none"> • WP 2a1 On board battery charger. • WP 2a2 DC-DC Converters for HEV, BEV and FC. • WP 2a3 Intelligent Power Switch (IPS). • WP 2a4 Portable EV Battery Charger. • WP 6a1 Intelligent Power Switch for Avionics. • WP 6a3 Isolated DC-DC High Voltage to 12V for HEV, EV, FC. • WP 6a6 Intelligent Power Switch for Railway.
Organization Description	<p>The “Dipartimento di Scienze matematiche e informatiche, scienze fisiche e scienze della terra” (University of Messina) deals with the development of scientific knowledge and education in the field of physics, math, informatics and earth sciences at every level. In particular, it promotes and coordinates the research activities in the fields of physics of the matter, nuclear physics, theoretical and applied physics. In the field of experimental characterization of power devices and of estimation of their lifetime and reliability, UNIME has more than ten years of expertise focused to the study of the silicon devices by applying microscopy and spectroscopy techniques. Also a complementary expertise in the field of modeling, simulation, design, and characterization of nanometer CMOS devices is available.</p> <p>The Dipartimento di Ingegneria (DI) is the School of Engineering of the University of Messina. It manages research activities in all fields of engineering and is responsible for teaching activities at BS, MS and PhD levels in the areas of Architectural, Civil, Electronic, Industrial, Information and Mechanical Engineering. Scientific and technological research in the Power Electronics field at DI has been focused in the last ten years on the development of new converter topologies and of advanced methodologies for reliability assessment. Among the last, fast thermodynamic analysis and thermal strain direct measurement techniques have been successfully proposed to predict the lifetime of SI and SiC devices.</p>
Key personnel involved	<p>Salvatore Patanè (Male)</p> <p>Current position: Associate Professor of Physics of Matter (FIS/03), in the “Dipartimento di Scienze matematiche e informatiche, scienze fisiche e scienze della terra”, University of Messina from 15/12/2010.</p> <p>He is author of over 100 publications in international journals and many conferences on solid-state physics, applied physics, electronics and materials science. The research concerns the realization of photonics and optoelectronics devices, the synthesis and the characterization of organic and polymeric materials of technological interest and</p>

	<p>the development of advanced microscopy and spectroscopy techniques with high spatial and temporal resolution with special attention to the characterization of power electronics devices.</p> <p>Antonio Testa (Male) Current position: Full Professor of Electrical Machines, Drives and Power Electronics (Ing-IND/32), Department of Engineering, University of Messina (from 02/03/2000).</p> <p>Main scientific interests of Prof. Testa concern the control of electrical drives, the generation from renewable energy sources, energy storage systems, electric propulsion, electronic devices and power converters. He is author of more than 230 papers published on international technical journals, or proceedings of international conferences. It is also co-author of three international patents. Since 1991 he is member of IEEE and collaborates with the activities of IAS, PELS and IES. Research projects managed by Professor Testa in the fields of electrical drives and power electronics have been funded by the Italian Ministry of University, the Italian Ministry of Industrial Development, ST-Microelectronics, CNR (the Italian Research Council) and some italian companies.</p>
<p>Significant infrastructure and/or any major items of technical equipment, relevant to the proposed work</p>	<p>In the past years, a prototype tool capable to measure the temperature distribution has been already realized. This setup have been successfully used to study the thermal behavior on silicon based power devices. In a valuable number of cases the data obtained have been used to solve some unexpected design bug, the lifetime was estimated too applying different theoretical models. Recently a system to study the mechanical deformations due to fast high current pulse has been developed. The instrument is able to detect the mechanical expansions of the surface with a resolution below few hundred of nanometers during the current pulse i.e. while the DUTs are operative. The system has already been applied on silicon power devices to verify their structural weaknesses and for reliability assessment. Moreover, in recent years specific Raman and x-ray photoelectron spectroscopy studies have been carried out on silicon Power MOSFET Dielectric Gate, evidencing the importance of chemical composition and spatial distribution in the assessment of device efficiency.</p> <p>An advanced power electronic laboratory is available at DI, equipped with a full set of last generation instruments.</p>

PARTNER N. 8 CESKE VYSOKE UCENI TECHNICKE V PRAZE (UNIPRA)	
<u>Role in the Project</u>	<p><i>The role of CTU in the project will be:</i></p> <ol style="list-style-type: none"> 1. <i>To develop fully functional electrical thermo-mechanical models</i> 2. <i>Exploit reliability and failure mechanisms of SiC structures including packaging taking into account all pressure and thermal constraints.</i> 3. <i>Revise all possible failure mechanisms at die level and at package level by innovative methods of modelling of acceleration factors to predict life time of SiC and package components at specific harsh environment conditions including electrical contacts and interconnection.</i>
Organization Description	<p>The Czech Technical University in Prague (shortly CTU) educates future experts in technical fields. The University develops scientific and educational research, creative and technical activities in accordance with the social requirements, worldwide trends and the principles of freedom of intellectual activities. CTU has 8 faculties.</p> <p>The Faculty of Electrical Engineering (FEE) is first-class research and education institute in electrical engineering, telecommunications, automation, informatics, and computer science & engineering. All study programmes are closely linked to the faculty's research activities. Even without the other CTU faculties, FEE ranks among the top 5 research institutions in the Czech Republic. FEE generates about 30% of the whole research output of CTU. In research, FEE collaborate extensively with top universities and research institutions worldwide and offers innovative solutions to our industrial partners.</p> <p>The Department of Microelectronics (established in 1977) belongs to the most significant Departments of the Faculty of Electrical Engineering because of rich research and educational results. The research activities are focused on Electron Devices (design, simulation, diagnostics and reliability), IC design, Optoelectronics and Microsystems. During the past years more than 1300 students graduated in the branch of Microelectronics, many Ph.D. or D.Sc. degrees have been also awarded. The Department maintains international co-operation with many universities and research institutions in the EU and worldwide. The Department has extended the links to many electronic institutions from which STMicronic, S3, ON Semiconductor, Honeywell, ABB Semiconductors AG, IMB-CNM, CADENCE, ASICENTRUM continuously play a dominant role in both the co-operative projects and support of postgraduate teaching.</p>
Key personnel involved	<p>Miroslav Husak, (male), (dipl. Ing, PhD., prof) full professor in Electronics and medical engineering branch FEE CTU in Prague (from 2000), MSc. (1978), Ph.D. (1984) CTU in Prague, branch Radioelectronics, research Fellow (1981), assistant professor (1984), assoc. professor (1997),. Head of the Department of Microelectronics FEE CTU in Prague (from 1997), head of the "Microsystems & integrated circuits" group. Research activities: Design and applications of microsystems, sensors and sensor systems, smart sensors and design of electronic instrumentation, electronic measurements, electronic devices and their design, signal processing, design and application of sensors and sensor systems in electronic instruments as well as diagnostics. Projects: Applicant of 17 national grants, investigator of 4 European grants (research, 6th European Framework, 7.FP EU, ENIAC , NATO for Peace,). Publications: Author of 1 monograph, 6 textbooks, more than 270 specialized publications in scientific journals, conference proceedings in the area of microsensors and microsystems.</p> <p>Jiri Jakovenko, (male) (dipl. Ing, PhD., assoc. prof) was born in Prague, Czech Republic, in 1972. He received the M.S. degree in Electronics and Economic (1996) and Ph.D. degree in microelectronics from the Czech Technical University in Prague, Faculty of Electrical Engineering CTU FEE (2004). He works as Associate Professor at the department of Microelectronics and vice-dean for education at CTU FEE. He is a member of Microsystems group. His research activities include electronics</p>

component reliability validation and modelling, thermo-mechanical modelling, integrated circuit design, MEMS design etc. Since 2004 he is leader of IC and MEMS design laboratory at CTU FEE. He is author and co-author of more than 60 scientific publications, co-author of chapter in Springer book; more than 30 publications are registered in WoS. He is member of IMAPS EDS scientific committee, reviewer for scientific journals as IEEE Transactions on Industrial Electronics, Microelectronics Reliability, Electron Device Letters, etc...

PARTNER N. 9 - GOTTFRIED WILHELM LEIBNIZ UNIVERSITAET HANNOVER (LUH)	
<u>Role in the Project</u>	<i>LUH will develop together with WÜRTH the gate drivers' transformers The IMPT will contribute the activities on WP3a: Advanced technology bricks development & characterization and WP7a: Communication & Dissemination, Exploitation, Standardization for Avionics, Railway and Automotive IPS</i>
Organization Description	The main focus of the research activities of the Institute of Micro Production Technology (IMPT) is the modelling and manufacturing of -especially based on magnetic effects- actuators, sensors and passive components (MEMS—Micro Electro Mechanical Systems). In addition, the characterization of MEMS from mechanical via magnetic to electrical properties and their adjustment is focussed. Development activities range from magnetic field sensors to measurement systems and micro motors, actuators to manipulation of micro-optical lens systems as well as optical measurements systems, and to passive components for electronic applications. Available to the scientific and technical staff of the IMPT for research activities, a class ISO 5 clean room, which, with its extensive facilities, allows for the implementation of microsystem processes for the production and analysis of MEMS and reliability studies. In addition, the IMPT has access to research laboratories, with which the mechanical processing and metrological characterization of microtechnical systems and materials are made possible. Therefore, the IMPT is well integrated into the comprehensive facilities of the Hannover Center for Production Technology (PZH) and strengthens the research potential of the PZH in the area of micro production technology.
Key personnel involved	Project Coordinator: Dr. Marc Christopher Wurz (male) received the diploma degree in Civil Engineering and a PhD in Mechanical Engineering from the Leibniz Universität Hannover. He has obtained great experience in the research field of microproduction technology covering the position of the deputy director of the Institute of Microproduction Technology (IMPT) for more than ten years. He is responsible of several national research projects for the IMPT in the field of microtechnology. He is the author of more than 50 technical papers, published on journals and proceedings of international conferences. His main scientific interests include processes for MEMS fabrication, magnetic sensors and actuators, energy harvesting and packaging technologies.
Relevant previous projects and activities involvement	The IMPT of the LUH has been active member of several former collaborative research centers (CRC 516, TR 37) funded by the German Research Foundation in the past and is currently involved in the CRC 653 and TR 123. Within these CRCs, the main focus of research at the IMPT is put on the development and realization of active as well as passive magnetic MEMS. Furthermore, in 2012 a cooperation between WÜRTH and the IMPT has been established and is successfully running up to date.
Significant infrastructure and/or any major items of technical equipment, relevant to the proposed work	Class ISO 5 clean room full equipped e.g. PVD, PECVD, IBE, DRIE, electroplating line, pick and place machine. Fully equipped photolithography room e.g. spin-coater, spray-developer, mask aligner Precision micro-machining equipment e.g. CMP, dicing Equipment for electrical, mechanical and magnetic properties characterization e.g. VSM, SEM, CFM, Nanoindenter.

PARTNER N. 10 CONSIGLIO NAZIONALE DELLE RICERCHE (CNR)	
Role in the project	<i>CNR will provide a complementary activity both in the processing and characterization with advanced techniques/methodologies. In particular, explorative studies on alternative dielectrics and characterization for metallization will be carried out. Additionally, wafer level characterization of the trapping phenomena in MOS-based SiC devices and test-patterns will be performed using several electrical analyses (as a function of the frequency, of the temperature and time-resolved), and correlated with nanoscale analyses of surfaces and interfaces (using advanced high resolution SCM, SSRM, C-AFM, Raman, TEM, PL etc.). CNR will also contribute with electro-thermal simulations of the devices behavior and simulation at an atomic level of the nature of the traps at SiO₂/SiC interfaces.</i>
Organisation Description	The Institute for Microelectronics and Microsystems (IMM) belongs to the National Research Council of Italy (CNR), has the headquarters in Catania and research units located in seven different sites in Italy (www.imm.cnr.it). The Institute has a permanent staff of about 200 people, with expertise in physics, chemistry and electronics engineering. The temporary staff counts also several Post-Docs and Ph.D. students. The activities of IMM are focused on innovative solutions for micro and nanoelectronics, advanced materials and processing for smart components, optoelectronics and photonics, sensors and multifunctional micro/nanosystems. The team involved in the present project has a recognized experience on wide band gap semiconductor materials (like SiC and GaN), processing, devices characterization and modelling, and has published more than 300 papers related to WBG semiconductors in the last 15 years. The Institute holds a relevant scientific relationship with STMicroelectronics, as the IMM headquarters in Catania has its labs inside an ST fab.
Key personnel involved	<p>Fabrizio Roccaforte, (Male), Senior Scientist, responsible for processing and devices fabrication in SiC and GaN at CNR-IMM. M.Sc. degree in Physics (1996) at the University of Catania, Italy and Ph.D. at the University of Göttingen, Germany (1999). Visitor scientist in Göttingen (2000), and advisor of STMicroelectronics (Italy) (2000-2001), before joining CNR-IMM (2001). He is co-author of more than 200 papers, 2 book chapters and four patents. He has been responsible for the CNR-IMM research unit within European and National projects on wide band gap semiconductors (MANSiC, NetFISiC, LAST POWER, Ambition Power). He has been the General Chair of the last ICSCRM2015 (www.icscrm2015.org).</p> <p>Antonino La Magna, (Male), Researcher, responsible for the computational team at CNR-IMM. M.Sc. degree (1992) and Ph.D. in Physics (1996) at the University of Catania, Italy. Since 1999, he is in the permanent staff at CNR-IMM, where he led the research group on advanced processes (2010-2015) and was member of the Scientific Council (2009-2015). He is and has been coordinator and responsible for CNR-IMM of several international projects and research contracts with industry. He is co-author of over 240 papers in international journals in the fields of theoretical solid state physics, and process/device simulations.</p> <p>Patrick Fiorenza, (Male), Researcher, expert in nanoscale and electrical characterization of dielectrics/semiconductor interfaces. M.Sc. degree in Physics (2003) and Ph.D. in materials science (2007) at the University of Catania, Italy. Since 2011 he is permanent researcher at CNR-IMM in Catania. He is co-author of more than 70 papers and has been involved in several European Projects on WBG materials.</p> <p>Raffaella Lo Nigro, (Female), Researcher, expert in growth (MOCVD, CVD, ALD) and characterization of advanced materials. M.Sc. Degree in Chemistry (1996) and the Ph.D. (2000) at the University of Catania, Italy, before joining CNR-IMM (2001). Her current research interests include the synthesis of high-k dielectric by Atomic Layer Deposition (ALD). She is co-author of more than 90 papers and 3 book chapters.</p> <p>Filippo Giannazzo, (Male), Researcher, responsible of activities on nanotechnology and expert on scanning probe microscopy-based electrical characterization. M. Sc. Degree in Physics (1998) and Ph.D. (2002) at the University of Catania, Italy. Post-</p>

	<p>doc at the University of Catania and at CNR (2002-2005), before joining CNR-IMM (2006). He is co-author of more than 190 papers and 4 book chapters. He is currently in charge for the Flag-ERA European Project GraNiTE.</p> <p>Francesco La Via, (Male), Senior Scientist, received the M.S. degree in physics from Catania University, Catania, Italy, in 1985. From 1985 to 1990, he had a fellowship at SGS-Thompson, Catania. In 1990, he joined the CNR as a researcher. Since 2003 he is responsible of the division of CNR-IMM that developed new CVD reactors and new processes for silicon carbide epitaxy and hetero-epitaxy. He has been responsible of several industrial research projects in the field of SiC epitaxial growth and new systems for CVD and sublimation growth. He has published more than 250 papers on JCR journals and two invited papers. He was Technical Program Committee Chair of ICSCRM2015.</p>
<p>Relevant previous projects and activities involvement</p>	<p>The group of IMM participated already in several European and National projects on wide band gap semiconductors (mostly SiC) where the development of new processes and characterization of relevant interfaces for devices has been targeted.</p> <ul style="list-style-type: none"> • ENIAC-JU project Last Power (2010-2014, www.eniac-lastpower.org) Large area SiC and GaN wafer for power electronics • National Projects PON Ambition Power (2010-2014) Technology platform for SiC MOSFETs and GaN HEMTs • FP7 Marie Curie Research Training Network MANSiC (2007-2010, www.mansic.eu) Development of materials and devices based on 3C-SiC • FP7 Marie Curie Initial Training Network NetFISiC (2011-2015, www.netfisc.eu) Study and optimization of interfaces on 4H-SiC • National Project PON Energetic (2012-2015) Development of high temperature metallizations for SiC devices • European Project FlagERA GraNitE (2016-2019) Integration of 2D materials onto nitrides based wide band gap heterostructures • Horizon2020 European Project CHALLENGE (it will start in 2017) Development of high quality 3C-SiC materials and devices
<p>Significant infrastructure and/or any major items of technical equipment, relevant to the proposed work</p>	<ul style="list-style-type: none"> - Clean Room ISO 4 (class 10) equipped for SiC and GaN devices processing - Atomic Layer Deposition (ALD) reactor Sentech in thermal and plasma-enhanced mode - Direct Writing Lithography System DWL66. - Inductively Coupled Plasma (ICP) Roth & Rau, with fluorine and chlorine chemistry - Metal sputter deposition systems (Ti, Al, Ni, Au, Cr, Pt,...). - Conventional and rapid annealing systems in different ambients (Ar, N₂, O₂). - Scanning Probe Microscopy Laboratory (Digital Instruments Dimension 3100 Nanoscope V with modules for SCM, SSRM, TUNA, C-AFM. Multimode with controller quadrex and stage for measurements up to 200°C. PSIA 150 Microscope with true non contact, and modules for capacitive and current measurements).

	- Structural (like XRD, HRXRD, TEM, EDX), electrical (like MMR K2500, I-V, C-V) characterization tools.
--	---

PARTNER N. 11 ZODIAC AERO ELECTRIC SAS (ZODAERO)					
<u>Role in the Project</u>	<p>ZODAERO will drive the technology development and the demonstrator for a multi-purpose inverter for avionics application.</p> <p>Innovative High Power Density Module, gate driver integration are the major topics from technology development.</p> <p>ZODAERO will implement the full inverter including the control part.</p>				
Organization Description	<p>ZODAERO is a world leader in electrical power distribution system and flight deck equipment, lighting systems and windshield wiper systems for aircrafts and helicopters. ZODAERO is also a leading company in aircraft electrical system including electrical generation, conversion, distribution and newly committed in energy storage devices. This unique position allows ZODAERO to guarantee the delivery of the right equipment for the right application. ZODAERO has fully integrated capabilities to specify, design and deliver safe, cost effective and compliant electrical systems .</p> <p>ZODAERO has about 1,200 people in France and invests approximately 15% of sales in R&D.</p> <p>ZODAERO fields of excellence are in engineering, development, manufacturing, repair and support of high-technology aerospace equipment and systems in the following markets:</p> <ul style="list-style-type: none"> ▪ Electrical Distribution Systems ▪ External Lighting Systems ▪ Flight Deck Solutions ▪ Windshield Wiper and Washing Systems <p>Among other subsystems included in power distribution system, ZODAERO is in particular designing/specifying converters and electrical protection systems.</p> <table border="1" style="width: 100%; border-collapse: collapse;"> <thead> <tr> <th style="background-color: #e1eef6;">ZEL works for the main players in the aeronautical sector:</th> <th style="background-color: #e1eef6;">The Electrical Systems developed by ZEL are currently supported in:</th> </tr> </thead> <tbody> <tr> <td style="vertical-align: top;"> <ul style="list-style-type: none"> ▪ Airbus ▪ Airbus helicopters ▪ Boeing ▪ Embraer ▪ Gulfstream ▪ Bombardier ▪ Dassault ▪ Irkut </td> <td style="vertical-align: top;"> <ul style="list-style-type: none"> ▪ Airbus A350XWB ▪ Airbus Helicopter Programs ▪ Falcon F5X ▪ Bombardier CL350 ▪ Bombardier G7000 ▪ Irkut MC21 </td> </tr> </tbody> </table>	ZEL works for the main players in the aeronautical sector:	The Electrical Systems developed by ZEL are currently supported in:	<ul style="list-style-type: none"> ▪ Airbus ▪ Airbus helicopters ▪ Boeing ▪ Embraer ▪ Gulfstream ▪ Bombardier ▪ Dassault ▪ Irkut 	<ul style="list-style-type: none"> ▪ Airbus A350XWB ▪ Airbus Helicopter Programs ▪ Falcon F5X ▪ Bombardier CL350 ▪ Bombardier G7000 ▪ Irkut MC21
ZEL works for the main players in the aeronautical sector:	The Electrical Systems developed by ZEL are currently supported in:				
<ul style="list-style-type: none"> ▪ Airbus ▪ Airbus helicopters ▪ Boeing ▪ Embraer ▪ Gulfstream ▪ Bombardier ▪ Dassault ▪ Irkut 	<ul style="list-style-type: none"> ▪ Airbus A350XWB ▪ Airbus Helicopter Programs ▪ Falcon F5X ▪ Bombardier CL350 ▪ Bombardier G7000 ▪ Irkut MC21 				
Key personnel involved	<p>Claire Marty (Female): Claire is an electronic engineer with 5 years of experience. She has worked during four years for Brightloop converters (a company specialized in the development of custom power supplies, power converters with digital control) on the development of a power supply for a laboratory laser diodes application and the realization of a 3kW DCDC converter for an electric vehicular application. Since 2013 she is developing a 4kW DC/DC converter and a 6kW inverter (Fuel Cell application). Her areas of expertise: power electronics, simulation, analog and digital electronics.</p> <p>Gerald Gusto (Male): Gerald is an electronic engineer that has worked for Zodiac Aero Electric since the end of his scholarship. He started his career by working on ATU/900W, TRU/250W and current sensors for B787 and A350 programs. He developed power electronics for lightning systems (LED, HID and discharge lamps) and became project manager for lightning systems on G250 and A350 programs. As a project manager he is now responsible for the development of a 2kW AC/AC frequency converter (Electrical distribution to passengers) and a 6,5kW DC/DC converter (Fuel Cell application). His areas of expertise: management, power electronics, simulation, analog electronics, sensing.</p>				

<p>Relevant previous projects and activities involvement</p>	<p>ZODAERO has more than 15 years of experience in European and French collaborative R&T projects like MOET, Clean Sky, Genome. The projects enable ZEL to work on the future electrical network that could be introduced on the next generation of aircraft and helicopters: the HVDC network (270 VDC & 540 VDC).</p> <p>Moreover, ZODAERO is involved in several R&T projects where it is in charge of the development of innovative converters:</p> <p>HYCARUS is a European collaborative project of the Fuel Cells and Hydrogen JU. Several converters are needed for a galley fuel cell application: a 4KW DC/DC converter, a 6kW DC/AC converter and a 6kW DC to AC converter providing galvanic insulation. Cabin power is an internal project aiming at developing converters to supply power to the In-Flight Entertainment equipment. Three converters were developed: a 2kW 115Vac@Variable Frequency/115Vac Fixed Frequency isolated PFC converter, a 300W 115Vac@Variable Frequency/115Vac Fixed Frequency isolated PFC converter and a 115Vac@Variable Frequency / 28VDC converter.</p>
<p>Significant infrastructure and/or any major items of technical equipment, relevant to the proposed work</p>	<p>ZODAERO has developed the following electronics for commercial aircraft applications:</p> <ul style="list-style-type: none"> - Complex control boards for primary distribution management - Battery management systems - Solid state controller boards for secondary power distribution - State of the art current sensors capable of measuring from low to high values - Power converters for DC/DC AC/AC and DC/AC conversion.

PARTNER N. 12 APOJEE	
<u>Role in the Project</u>	<p><i>APOJEE will design a specific test bench for the validation of the Converter/Inverter using SiC components.</i></p> <p><i>APOJEE will work on the Work Package 6a, a specific task (WP6a.7) is dedicated to the Test Equipment development.</i></p> <p><i>The demonstrators from VSCM and NEXTER will be validated with this equipment, the specification of the Test, the setup and the execution are part of each demonstrator development tasks.</i></p> <p><i>The test equipment is fully convenient to Test and Integration phase of the V-model.</i></p> <p><i>Key words:</i></p> <p><i>Power Electronics, Validation, Test, Integration, High Voltage, High Frequency Switching, V-Model.</i></p>
Organization Description	<p>APOJEE is a French company with more than 50 engineers and technicians acting as a supplier of high-technology in the fields of power electronics, embedded control units and ignition / combustion, for automotive, aerospace and defense market.</p> <p>The APOJEE activities are conducted primarily in the following fields :</p> <ol style="list-style-type: none"> 1. Design, development, manufacture and marketing of own products for laboratories, BE, testing and validation services, and manufacturing 2. Design, development, industrialization and production support to customer products, 3. Study, implementation, development of specific technical equipment, 4. High-Level consultancy work. <p>APOJEE works on the complete life cycle of a product up to mass production support with experienced engineers (> 20 years for some) in the fields of marketing, electronic development, embedded software systems, electromagnetic compatibility, industrialization and quality.</p>
Key personnel involved	<p>Olivier METZELARD (male) : APOJEE founder – CEO</p> <p>25 years of experience in automotive electronics,</p> <p>Head of electrical vehicle electronics R & D for PSA & BMW applications at SAGEM.</p> <p>R & D Manager for ignition coils at SAGEM</p> <p>Creation of APOJEE in 1999</p> <p>Development of SmartCoil : an unique Ignition Coil emulator</p> <p>Development of MARVEL : an AC/DC test bench dedicated to electrical vehicle component validation</p>
Relevant previous projects and activities involvement	<p>APOJEE has a recognized position in these areas of competence and as such is referenced for key accounts in the Automotive industry and Aerospace: BMW, Renault, Valeo, Safran, Zodiac Aerospace,... but also smaller companies (100-300 people) willing to integrate electronics functions in their products or in search of new markets for new product families.</p>

PARTNER N. 13 aPSI^{3D}	
<u>Role in the Project</u>	aPSI ^{3D} is offering a 3D packaging technology applicable to fast switching. This technology will be improved so that the benefits of low inductance and double-side cooling can benefit to SiC. aPSI ^{3D} will deliver prototypes as per end-user requirements.
Organization Description	aPSI ^{3D} is an independent innovative company created in 2013. It raised funds in 2015 in order to industrialize its products. aPSI ^{3D} designs and manufactures highly compact, low inductance, high power switches for power inverters.
Key personnel involved	<p>Dr. Jacques FAVRE (male) was born in 1962 in Paris (France). He was previously graduated from Ecole Polytechnique. He completed his PhD at SESI, a common laboratory to CEA and Ecole Polytechnique, He then first joined Thomson-CSF's Central Research Lab, in charge of GaAs mm-wave transistors. Director at Thomson TCS, he led the operational launching of ums (united monolithics semiconductors), a joint venture with Daimler-Benz. In 1996, he joined Motorola Semiconductors as MOS20 Operations Director, heading the mixed signal facility in Toulouse, France. In 2001, he moved to Phoenix, Arizona, and turned around the operations in charge of power amplifiers for mobile phones. Back in France in 2004, he served as the General Manager of Freescale Semiconducteurs Centre de Recherche Crolles SAS. After a few years with Michelin where he revamped the tyre electronics strategy, he returned to genuine electronics to start aPSI^{3D} up.</p> <p>Jean-Michel REYNES (male) is a senior expert in device engineering and process integration. He served for more than 30 years at Motorola / Freescale where he developed many new technologies and new products. He joined aPSI^{3D} in 2014 in order to master the die contribution to the power module performance.</p>
Relevant previous projects and activities involvement	Being a Start-up, aPSI ^{3D} cannot claim for relevant past projects.
Significant infrastructure and/or any major items of technical equipment, relevant to the proposed work	aPSI ^{3D} has direct access to various equipment and know-how at PRIMES innovation platform in Tarbes, France, at IRT St Exupery in Toulouse, France and at LETI in Grenoble, France. Thus, everything necessary to fabricate and test prototypes is available to aPSI ^{3D} .

PARTNER N. 14 SAT Group (SAT)	
<u>Role in the Project</u>	SAT will provide its expertise in the design and manufacture of wet bench and SRD for all the necessary tests to be performed on the Power Module. In particular, the pilot line will be arranged and equipped to support fully-automated wet processes (etching, cleaning) planned for the steps of prototypes fabrication, also providing an integrated SRD device for rinse and drying.
Organization Description	SAT has thirty years of experience in the distribution process of chemicals, primarily in the semiconductor and pharmaceutical industry . Since 1987, SAT designs and manufactures components in ultra-pure thermoplastic material, obtained by machining or molding . Since 2005, SAT expanded its production divisions with the design and realization of modular Wet Bench, mainly dedicated to the applications required by the semiconductor industry, pharmaceutical and solar.
Key personnel involved	Dr. Aldo Giuseppe Di Leo (male) , General Administrator Dr. Ilaria Di Leo (female) , studied Business Administration at Austin Community College (TX, USA) Dr. Ing. Fabio Giudice (male) studied Mechanical Engineering in the field of precision engineering at University of Catania.
Significant infrastructure and/or any major items of technical equipment, relevant to the proposed work	Our headquarter is based in Sicily, industrial area south Catania. With our ultrapure cleanroom, we can guarantee a high quality of manufacturing for the components and machinery. In addition, the prototypes will be designed and developed according to the test specifications required in the project.

PARTNER N. 15 WURTH ELEKTRONIK EISOS GMBH & CO KG (WÜRTH)	
<u>Role in the Project</u>	<i>WÜRTH will participate to the development of technologies for passive components at high level of integration. Particularly WÜRTH will collaborate with LUH in the development of gate drivers' transformers.</i>
Organization Description	<p>WURTH ELEKTRONIK EISOS GMBH & CO KG is a manufacturer of electronic and electromechanical components for the electronics industry. WURTH ELEKTRONIK EISOS GMBH & CO KG is part of the WÜRTH Group, the global market leader for fastener technology. The company employs currently 6,100 people and generated sales of 400 million Euro in 2014.</p> <p>As one of Europe's largest manufacturer of passive components, WURTH ELEKTRONIK EISOS GMBH & CO KG product range covers EMC Components, Capacitors, Inductors, RF Inductors and LTCC Components, Transformers, Components for Circuit Protection, Power Modules, LEDs, Connectors, Switches, Power Elements in Press-fit Technology and Assembly Technique.</p> <p>WURTH ELEKTRONIK EISOS GMBH & CO KG is active with direct sales in 40 countries worldwide. 13 manufacturing facilities located in all important markets worldwide guarantee the rapid delivery of components.</p>
Key personnel involved	<p>Dr.-Ing. Dragan Dinulovic (male) studied mechanical engineering in the field of precision engineering at University of Nis (Serbia). He received his PhD from Leibniz University Hannover on microtechnology and MEMS in Year 2007. From 2000 to 2010 he did research at Institute for Microtechnology (IMPT) in Hannover. His research area was the development of magnetic MEMS devices like magnetic microsensors and microactuators. He contributed to several EU, DFG, and BMBF projects. In 2010 he joined WURTH ELEKTRONIK EISOS GMBH & CO KG as R&D engineer, where his focus is on the development of thin-film passive component like inductors and transformers, on integration of passive and active power devices into one package (Power supply in Package (PSiP)). He is author of more than 25 papers in magnetic MEMS and thin-film technology.</p> <p>Dipl.-Ing. Martin Haug (male) holds a degree in electrical and electronic engineering of the University of Applied Science in Ulm. After working more than 15 years in the area of automotive smart power ASIC design with STMicroelectronics and Bosch Semiconductor, he joined WURTH ELEKTRONIK EISOS GMBH & CO KG in 2014. At WURTH ELEKTRONIK EISOS GMBH & CO KG he is responsible for the R&D of PSiP solutions and advanced magnetic components.</p>
Significant infrastructure and/or any major items of technical equipment, relevant to the proposed work	<p>WURTH ELEKTRONIK EISOS GMBH & CO KG has established a R&D Center for PSiP and advanced magnetic components design at its Garching site. At the headquarter in Waldenburg WURTH ELEKTRONIK EISOS GMBH & CO KG has a world class quality center for any kind of reliability tests and failure analysis of electronic components.</p>

PARTNER N. 16 – UNIVERSITE FRANCOIS RABELAIS DE TOURS (UNITOU)	
Role in the project	<p><i>The role of GREMAN will be in the development of processes for high level of integration. Particularly:</i></p> <ul style="list-style-type: none"> - <i>To contribute to the understanding of the impact of grinding process on both physical and electrical properties of SiC thinned wafers</i> - <i>To develop innovating processes for high electrical quality backside contacts on SiC thinned wafers</i>
Organization Description	<p>GREMAN is a recent research group, issued from the merger, in 2012, of three laboratories at Tours University (UNITOU). The GREMAN has now the status of UMR (7347) of CNRS/University of Tours. The main activities of GREMAN are elaboration and characterization of materials, physics of condensed mater as well as nano and microelectronics, mainly focused on power and RF electronics. Concerning power electronics activity, GREMAN has started researches on wide bandgap materials, in particular SiC and GaN, since 2004. GREMAN has nowadays a multidisciplinary competence, covering all the fields from the materials science to the device development.</p> <p>Besides, GREMAN is a founding member of CERTeM (Centre d'Etudes et de Recherches Technologiques en Microélectronique) in Tours, that gives the full access to the technological platform necessary to achieve (photolithography, sputtering, ICP etching ...) and to characterize electrical devices.</p>
Key personnel involved	<p>Jean-François MICHAUD (male), 39 years old, is an associate professor at the University of Tours. In 2004, he received the Ph.D. degree in electronics, from the University of Rennes 1. Since September 2006, he is an associate professor at the University of Tours. His current research, in the GREMAN laboratory, focuses mainly on silicon carbide for electronic and MEMS applications. In 2011, he participated to the organization of the international HeteroSiC - WASMPE'11 conference, which held in Tours. He has participated to several projects (ANR Nanosens, OSEO G2REC, AAPR Mat&Mut) and is the leader of a PHC PROCOPE project on SiC, with IPHT of Jena (Germany). With Pr. Daniel Alquier, he supervised 5 PhD students (+ 1 current) including 5 on silicon carbide (3C-SiC and 4H-SiC). He is author or co-author of a book chapter, 16 papers in international revues, 25 papers in international conferences, 6 invited talks in international conferences (1 presented) and 1 patent pending.</p> <p>Daniel ALQUIER (male), 47 years old, Professor at the University of Tours. Since 1999, he was hired as associate professor at the University of Tours, where he developed activities including ion implantation and defect engineering in semiconductors, MEMS and wide bandgap semiconductors for power applications. In this context, he did a 6-month stay as visiting researcher at CNR-IMM Catania, Italy (partner 15 in this project). He was promoted as university professor in 2005. In 2009, he became director of the LMP laboratory and Deputy Director of GREMAN, a new group issued from 3 laboratories, in 2012. Since May 2016, he is vice-president of the university of Tours, in charge of partnerships and innovation.</p> <p>He has participated and participates in European (Eureka), national (OSEO, ANR, RNTS) and regional projects for which he was responsible for the laboratory.</p>
Relevant previous projects and activities involvement	OSEO-G2REC, ANR-Nanosens
Significant infrastructure and/or any major items of	GREMAN is a founding member of CERTeM (Centre d'Etude et de Recherche Technologique en Microélectronique) in Tours. Hence, GREMAN will use this technological platform to achieve project issues using front-end facilities such as ICP etching, chemical Benches (2'' to 8''), deposition tools (e-beam, PVD) as well as

technical equipment, relevant to the proposed work	characterization facilities (AFM , SEM, TEM, FIB-STEM, probe stations ...) and back-end one such as grinding, dicing, ...
--	---

PARTNER N. 17 INSTITUT MIKROELEKTRONICKÝCH APLIKACÍ S.R.O. (IMA)	
<u>Role in the Project</u>	<p>Key words:</p> <ul style="list-style-type: none"> • SiC power components in a smart actuator for industry system automation • Low Power WAN for remote energy controlling • Out-door & in-door devices within industry systems • HW and SW development
Organization Description	<p>Institute of Microelectronic Applications s.r.o. (IMA) is a limited private company (SME) located in Praha and Pardubice (CZ). Being on the market since 1992, IMA is well established in the smart card business and follow up micro technologies bridging towards nanotechnology. IMA deals with electronic identification and utilizes smart cards, RFID/NFC, biometrics and wireless ZigBee technology. For 2 years IMA was chairing WG cards of EFMI (European Federation for Medical Informatics). IMA represents CZ in ISO and CEN groups for standards in health care domain. Beside this, IMA was key partner for BioHealth project / awarded by Europe INNOVA/, in which proactive repository of standards for IDM, security and BioHealth has been created (more than 200 standards across ISO, CEN, ETSI and GS1). Providing large systems in CZ, IMA is now launching application hosted in NFC mobile set and collaborate with mobile operators on management of identities. Within real applications running IMA is piloting various advanced technologies. IMA also provides integration services in terms of: a) merging new eID systems into the existing infrastructure, b) meeting legal regulatory base for eServices applied cross boarder within EU, c) ensuring privacy and personal data protection and d) data fusion and mining, profiling and correlations detection among identified objects. This ensures safety and security for supervised persons at public spaces. Within EU projects (Artemis, Eniac, Catrene) IMA delivered electronic devices and applications for automotive and building domain – car data remote monitoring, car sensor data processing, advanced access management, EV charging data concentration, air quality monitoring services.</p>
Key personnel involved	<p>Tomáš TRPIŠOVSKÝ (Dipl.Eng., PhD), (male) Titles: President / CEO of IMA. Graduated on the Czech Technical University at Prague (CVUT) in 1977 and in 1987 he acquired PhD in computer science CVUT, Prague. Establishing IMA in 1992 he is managing the company. Focused onto international project management, harmonization and standardization in the eID, smart cards, RFID and biometrics. Other activities: Co-chair of EFMI WG Card, (2003-2005), representing Ministry of Finance CZ in eEurope SCC activity for smart cards (since 2003), eEurope SCC (TB11,TB7 member) (2000-2003), engaged as local expert for Phare project (1995-1996).</p> <p>Jiří HAVLÍK (Dipl.Eng.), (male) Titles: Head of telematics dep., Senior Consultant. Graduated 1987 Czech Technical University in Prague, Faculty of electrical engineering. Activities, 1987–1991: Research Institute of Communication A.S.Popova, research and development engineer, 1991 – 1992: Tesla ELTOS, programmer, since 1992 at IMA. Participation on relevant projects: Schlumberger competence centre in IMA for software maintenance; since 2007 represented IMA in two the FP7 projects Symbion-Replicator and Matthew. Since 2008 represents IMA in ENIAC, ARTEMIS projects Pollux, MAS, IoE, IDEAS, EM4EM and others.</p>

PARTNER N. 18 E-Distribuzione S.p.A. (ED)	
<u>Role in the Project</u>	ED role will include requirements, specifications and demonstration validation of a high efficiency Bidirectional SiC-based Power Converter for V2G/V2H applications, which ED trusts would enable a stronger and faster spread of electric vehicles in the market thanks to savings reachable by a V2G technology through savings on energy consumption and service provided to TSO and DSO
Organization Description	<p>E-distribuzione S.p.A. is a Distribution System Operator (DSO) and a subsidiary of the ENEL Group, Italy's largest power company and Europe's second listed utility by installed capacity. With about 32 million consumers and more than 1,100,000 km lines, Enel Distribuzione is the second largest DSO in Europe. As well as providing power distribution services to its household and business consumers, the company runs R&D activities with the aim to constantly improve supply services to consumers and facilitate new advanced services to the customers in the framework of smart grids developments. Solutions for the integration of renewable energy sources as well as the active participation of customers in the management of the electricity network have been investigated and tested by the company under different national and European projects.</p> <p>The Shareholders Meeting of Enel Distribuzione S.p.A. has resolved, on June 14th, 2016, the change of the company name from Enel Distribuzione S.p.A. to « e-distribuzione S.p.A. », with effect from July 1st 2016.</p> <p>The company name does not imply any other change of the legal data of the company and specifically the registered seat, the commercial register number, the VAT ID will remain the same. Furthermore, also other reference data - among which, as by way of example and not exhaustive, bank accounts, scheduling/shipper codes and all other details and structures of the company as well as current contracts and other agreements remain unchanged and unaltered, with corresponding obligations and rights assumed under the new name. So all business correspondence, including invoices, will send with the new company name (e-distribuzione).</p>
Key personnel involved	Tommaso Difonzo (male) Engineering, he is currently employed in the Network Technology Division Italy of e-Distribuzione S.p.A His responsibilities include the development of the recharging systems for electric vehicles, the coordination of the different areas of Enel Group involved in electric mobility, thanks to his current experience in Endesa Group. In his previous experience in Enel Innovation Unit, he was involved in the research of new business models which would have helped the spread of electric-cars in the market.
Significant infrastructure and/or any major items of technical equipment, relevant to the proposed work	<p>e-Distribuzione is heavily engaged in developing efficient and technologically advanced solutions to promote and favor electric transport. In 2014 in Italy, Enel completed the alternating-current charging solution and created the first multi-standard rapid charging station.</p> <p>Furthermore, Enel is already involved in some pilot project involving bidirectional technology, running the first V2G hub in the city of Copenhagen.</p>

PARTNER N. 19 SOFTECO Sismat Srl (SOFT)	
<u>Role in the Project</u>	<p>SOFTECO will participate to ESIF funded work packages WP2b.2, WP6b and WP7b.</p> <p>SOFTECO in collaboration with UNICT will participate to the project to define the specification and to implement a) different control algorithms for the innovative inverter developed by the other partner (DTSMNS via UNIPA /DEIM and DAC) b) intelligent energy management optimization strategies.</p> <p>The control and energy management algorithms must be adapted to the particular operating conditions for the airborne application in order to drive the motors respecting the flight plan optimizing the dynamic stability and power consumption.</p>
Organization Description	<p>Established in 1979, Softeco Sismat Srl (www.softeco.it) is a mid-size, highly innovative SME and a software systems provider in several sectors, including industry, telecommunications, finance and government. The company is a major supplier of software and automation systems within complex industrial application in Italy and Europe, using advanced IT methodologies, hardware and software tools.</p> <p>With its headquarters located in Genova and branch offices in Milan, Naples and Catania, Softeco Sismat has currently a staff of about 240 professionals, including system, project and research engineers, software analysts and developers. The turnover is around 19 million EURO with a constant growth over the last 10 years.</p> <p>Softeco Sismat's software systems include applications in various market segments such as e-Business and Mobile-Work solutions in different industrial sectors (e.g., manufacturing, automotive, shipping, biotech, etc.) and service markets (e.g., infomobility, transport, tourism and travel, logistics, health care, etc.), and mission-critical ICT solutions for large industrial, public, and private organisations in various areas (e.g., energy production and distribution, telecommunications, traffic and transportation, finance).</p> <p>Softeco Sismat's is an innovation oriented company: in over 20 years of activity, thanks to a collaboration network of over 800 European companies and research centres, Softeco Sismat's Research & Innovation department took part - also as Project Coordinator - in more than 80 research projects (www.research.softeco.it). These include projects funded by the European Commission under various Framework Programmes - starting from FP3 onwards, up to FP7 and H2020 - and in other major initiatives such as, e.g., eContent, eContentPlus, eTEN, ICT-PSP, LIFE/LIFE+. Softeco Sismat is also a major player in the national research and innovation arena, with participation to a large number of National and Regional initiatives.</p>
Key personnel involved	<p>Marco Boero (male), Head of Research and Innovation Division, M. Sc. degree in Computer Science and Electronic Engineering from the University of Genoa (www.research.softeco.it/marco-boero.aspx). His background includes advanced ICT solutions for the industry in various areas, including applications for transportation and mobility, e-Work/m.Work, Computer Supported Cooperative Work, manufacturing, training, resources and risk management. He is experienced in advanced information technology and modelling methods, including Artificial Intelligence and Knowledge Based Systems, simulation, Cooperative Working and Decision Support Systems. He is author of several international papers and co-Editor of two books on Artificial Intelligence applications to transportation and traffic engineering and on ICT applications to infomobility and traffic information. He has some twenty year experience in the field of RTD projects both at the national and European level and has been involved in numerous projects under various programs, in some as the Project Coordinator, starting from the EC Framework Program 3</p>

	<p>onwards, up to the current FP7. As regards transport and mobility related RTD projects, he was or is currently involved in a number of projects including EcoGem (FP7, ICT Green Cars, 260097), In-Time (CIP, ICT-PSP-2008238880), eMOTION (FP6-TREN-019939-SUSTDEV), CARAVEL (IP FP6-513553, CiViTAS), CONNECT (CA FP6-PLT-506959), CEDM (LIFE ENVT/IT/000870), FAMS (IST-2001-34347), eDRUL (IST-2001-34241), COSTE (eContent EDC 4130/28459), INVETE (IST-1999-10311), ENTERPRICE (TAP TR1020), SAMPLUS (TAP TR2043), SAMPO (TAP TR1046), SMARTTEST (FP4, TPT). He actively participated to the work of ERUDIT Network of Excellence, Technical Committee C "Traffic". He has recently coordinated the MyWay project (FP7 G.A. N° 60902).</p> <p>Gianni Viano (male), M. Sc. with a degree in Electronic Engineering from the University of Genoa. He has more than 15 years' experience in RTD in ICT projects in national and European programmes including AMEBICA (4th FP, ESPRIT; multi - agent technology for advanced adaptive HCI systems) and HISCORE (5th FP, IST; advanced imaging applications for 3D colour camera), PELLUCID (5th FP IST, Intelligent Environment for Public Sectors Employees at all levels), K-WfGrid (6th FP, enable the knowledge - based support of workflow construction and execution in a Grid computing environment). He has been the Project Coordinator of the WORKSAFE (eContent) and EuroWorksafe (eTEN) projects.</p> <p>Sebastiano De Fiore (male) has got a Master of Science in Informatics Engineering in 2005 and he received the Ph.D in in Electronics and Automation Engineering in 2008, from the University of Catania, Italy. He has been working in Softeco since 2010. At present he is a Senior Engineer and Project Manager in projects related to the energy world.</p> <p>He published more than 30 technical papers in national and international conferences and journals related to robotics, bio-robotics, soft computing and photovoltaic plant forecast.</p> <p>Sebastiano De Fiore has participated more than 10 projects in National and European programs (i.e. SPARK, SPARKII, RAPOLAC, VAIMA, SIMONE, CREEM, etc.). His main activities are covering energy consumption optimization and photovoltaic plant modelling and simulation related both to Project management and technical topics.</p> <p>Francesco De Fiore (male) has got a Master of Science in Informatics Engineering in 2009 from the University of Catania, Italy. He has been working in Softeco since 2008. At present he is a Senior Engineer and Project Manager.</p> <p>Over the years he has worked on several projects for major clients in oil&gas, energy management and industrial production.</p> <p>Francesco De Fiore has participated some projects in National and European programs (i.e. VAIMA, SIMONE, CREEM, etc.). His main activities are the development of research and industrial activity, especially project management and technical topics.</p>
<p>Significant infrastructure and/or any major items of technical equipment, relevant to the proposed work</p>	<p>SOFTECO will provide the ICT laboratory based in Catania and Naples. It is equipped with hardware and software tools to support high quality software design and development including development cycle management and quality check.</p>

PARTNER N. 20 DISTRETTO TECNOLOGICO AEROSPAZIALE DELLA CAMPANIA (DAC)	
<u>Role in the Project</u>	Responsible for the development of two airplane avionic demonstrators. It will also contribute in the definition of requirements for SiC components as coming from aerospace sector, with specific regard to an UAV system under development. DAC will further contribute in the dissemination and communication activities.
Organization Description	<p>The Campania Technological Aerospace District was established on 30 May 2012 under the auspices of the Italian Ministry of Research with the aim to contribute harmonizing the interaction of all stakeholder on the regional territory to favour the development of competitive capabilities within the Campania aerospace industry. The Campania industrial tradition and the presence on the territory of actors of the innovation represented by Universities and Research Centers is not sufficient to further enhance industrial development and to maintain a primary role on the international scenario.</p> <p>DAC is participated by 154 entities: 12 large industries (as Leonardo, MBDA, Magnaghi Aeronautica, Atitech, DEMA, Telespazio, ALA, I.D.S.), 12 research centres and universities (as CIRA, CNR, ENEA, Formit, 5 universities), and 130 SME's (most of which grouped into 8 Consortia, one of these SMEs consortia is CALTEC that is directly involved via its members Redam and OMI in the present project providing person-power and taking care of the core technical aspects of the DAC participation). Research funds are focused on strategic projects for Aerospace with an effective fall out on industrial applications.</p> <p>DAC's transversal initiative tends to enhance the capabilities of the whole regional network and enhance its visibility with the outside Aerospace world.</p> <p>DAC is supporting the consolidation of an aerospace education Pole in Campania, finalized to shape profiles and competences, which directly meet the Industry needs.</p> <p>The strategic vision and role of DAC is to manage a network system of research and education enabling to interface with national and international actors and promoting a vision that is typically industrial and market oriented on the following lines:</p> <ul style="list-style-type: none"> - Commercial Aviation – to develop enabling methodologies and technologies aimed to design and produce a Regional Aircraft; - Business & General Aviation – to develop innovative low cost composite fabrication and assembly techniques for General Aviation vehicles; - Space and Launchers – to design and develop space platforms such as microsattellites, suborbital vehicles, and dual use technologies associated with launchers and systems including payloads and sensing systems; - Maintenance and Overhauling – to develop innovative methodologies and technologies for maintenance and overhauling procedures. <p>DAC operates vertically favouring synergies amongst its members since the preliminary phases of the Research, addressing innovation in future programs.</p> <p>It introduced a system of collaborative project and knowledge management by which all partners may operate independently within an integrated vision.</p> <p>Horizontal activities include:</p> <ul style="list-style-type: none"> - Project & Knowledge Management - Technology Transfer & Communication - Internationalization & relations with other Districts - Professional & High Education - Dual use
Key personnel involved	<p><i>Gennaro Russo, (male) Ph.D. in Aerospace Engineering</i> <i>DAC, Aerospace Technological District of Campania Region</i> Senior Expert on Space and Launchers, Systems and Dual Use. Main activities and responsibilities Ambassador at national and international level, participation in the development of technology</p>

Coordinates the DAC Education projects and is member of the Technical Committee of FACA, Fondazione Aerospazio Campania Academy

**Michelangelo Giuliani, (male) Phd in MECHANICAL ENGINEERING
REDAM CEO/CTO**

Main activities and responsibilities DESIGN AND PROJECT MANAGEMENT
C-Series Bombardier, B787, C27J, A380, Falcon 2000, TECNAM Aircraft Design

Table 2: Relevant Publications (Journals, Conferences, IP deposition)

Partner	Publications
UNICT	S. De Caro, O. Giordano, T. Scimone, A. Testa and M. Cacciato, "A dual boost-NPC inverter working in time sharing mode," <i>2016 International Symposium on Power Electronics, Electrical Drives, Automation and Motion (SPEEDAM)</i> , Anacapri, 2016, pp. 962-967.
UNICT	G. Scarcella; G. Scelba; M. Cacciato; M. Harbaugh, "Vector Control Strategy for Multidirectional Power Flow in Integrated Multi-Drives Starter-Alternator Applications," in <i>IEEE Transactions on Industry Applications</i> , 2016, Early access, p.1-9
UNICT	M. Cacciato, L. Finocchiaro, A. Raciti, G. Scarcella and G. Scelba, "EMI filters components using planar magnetic technology," <i>2015 AEIT International Annual Conference (AEIT)</i> , Naples, 2015, pp. 1-6.
UNICT	M. Pulvirenti, G. Scarcella, G. Scelba, M. Cacciato and A. Testa, "Fault-Tolerant AC Multidrive System," in <i>IEEE Journal of Emerging and Selected Topics in Power Electronics</i> , vol. 2, no. 2, pp. 224-235, June 2014.
UNICT	M. Cacciato, S. D. Caro, G. Scarcella, G. Scelba and A. Testa, "Improved space-vector modulation technique for common mode currents reduction," in <i>IET Power Electronics</i> , vol. 6, no. 7, pp. 1248-1256, August 2013.
UNICT	M. Cacciato and A. Consoli, "New regenerative active snubber circuit for ZVS phase shift Full Bridge converter," <i>Applied Power Electronics Conference and Exposition (APEC), 2011 Twenty-Sixth Annual IEEE</i> , Fort Worth, TX, 2011, pp. 1507-1511.
VALEO	Gang Yang, Patrick Dubus, "Dispositif d'un nouveau transformateur résonant appliqué dans un convertisseur résonant LLC", MFR0902, 04/2014
VALEO	Gang Yang, Patrick Dubus, "Procédé et dispositif de commande d'un convertisseur multi-phase courant continu-courant continu à résonance, et convertisseur multi-phase correspondant", MFR0777, 04/2013
VALEO	H.SADKI, P. DUBUS, G. YANG, L. BENDANI, "CONVERTISSEUR DE TENSION COMPRENANT UN CIRCUIT CONVERTISSEUR A RESONNANCE, MFR1456215
VALEO	L. DE SOUSA, « Convertisseur de tension continue et procédé de commande associé » MFR1458573
VALEO	H.SADKI, L. BENDANI, « CONVERTISSEUR DE TENSION COMPRENANT UN CIRCUIT CONVERTISSEUR DC/DC ISOLE », MFR1456219
VALEO	L. DE SOUSA, « VT Flyback-Forward with Acctive Rectifier 2 », MFR1459957
VALEO	H.SADKI, L. BENDANI, « Flyward+buck ou boost_pat » , MFR1456219
VALEO	L. BENDANI, « FlyWard & Boost command », MFR1456226
VALEO	L. DE SOUSA, « FlyWard & Buckboost Combination », MFR1459951

LUH	J. Rittinger, P. Taptimthong, L. Jogschies, M. C. Wurz, L. Rissing: Impact of Different Polyimide-based Substrates on the Soft Magnetic Properties of NiFe Thin Films. Proc. SPIE 9517, Smart Sensors, Actuators, and MEMS VII; and Cyber Physical Systems, 95171R, doi:10.1117/12.2178765, 2015
LUH	D. Dinulovic, M. Kaiser, A. Gerfer, O. Opitz, M.C. Wurz, L. Rissing: active with Closed Fe-Co Magnetic Core for High Frequency Power Applications. AIP Journal of Applied Physics 115, 17A317 (2014); doi: 10.1063/1.4863930, 2014
LUH	D. Dinulovic, M. Kaiser, A. Gerfer, O. Opitz, M.C. Wurz, L. Rissing: Thin-film Microtransformer for High Frequency Power Applications. EPJ Web of Conferences, Vol. 75, Art. 06006, 2014
LUH	A.Belski, P. Taptimthong, M. C. Wurz, L. Rissing: High permeability flexible bulk material for magnetic micro head applications. JEMS 2012, EPJ Web of Conferences, Vol. 40, 16003, 2013
LUH	A. Belski, M. Wurz, J. Rittinger, L. Rissing: Development, Micro Fabrication and Test of Flexible Magnetic Write Head for Gentelligent Applications. Proc. 38 th Int. Conf. on Micro & Nanoengineering, Toulouse, France, 2013, Microelectronic Engineering 110 (2013) 315-319, 2013
UNITOU	“Electrothermally driven high-frequency piezoresistive SiC cantilevers for dynamic atomic force microscopy”, R. Boubekri, E. Cambril, L. Couraud, L. Bernardi, A. Madouri, M. Portail, T. Chassagne, C. Moisson, M. Zielinski, S. Jiao, J.-F. Michaud, D. Alquier , J. Bouloc, L. Nony, F. Bocquet, C. Loppacher, D. Martrou and S. Gauthier, J. Appl. Phys. 116, 054304 (2014)
UNITOU	“3C-SiC: new interest for MEMS devices“, J.F. Michaud , M. Portail, T. Chassagne, M. Zielinski and D. Alquier , invited talk at HeteroSiC – WASMPE’13, Nice (France), 17-19 Juin 2013, published in Materials Science Forum, Vol 806, pp. 3-9, Oct. 2014
UNITOU	“Aluminum implantation in 4H-SiC: physical and electrical properties”, J.F. Michaud, X. Song, J. Biscarrat, F. Cayrel, E. Collard and D. Alquier , ECSCRM 2012 Saint Petersburg (russia) september 2-6 2012 published in Materials Science Forum 740-742, 581 (2013).
UNITOU	“ICP etching of 4H-SiC substrates”, J. Biscarrat, J.F. Michaud, E. Collard and Daniel Alquier , ECSCRM 2012 Saint Petersburg (russia) september 2-6 2012 published in Materials Science Forum 740-742, 825 (2013).
UNITOU	“Evidence of electrical activity of extended defects in 3C-SiC grown on Si”, X. Song, J.F. Michaud, F. Cayrel, M. Zielinski, M. Portail, T. Chassagne, E. Collard and D. Alquier , Applied Physics Letters Vol. 16, N°14 (2010)
IUNET	S. Reggiani, G. Barone, S. Poli, E. Gnani, A. Gnudi, G. Baccarani, M.-Y. Chuang, W. Tian, R. Wise “TCAD simulation of hot-carrier and thermal degradation in STI-LDMOS transistors”, IEEE Trans. on El. Dev., Vol. 60, no. 2, pp. 691–698 (2013).
IUNET	Cornigli, D.; Monti, F.; Reggiani, S.; Gnani, E.; Gnudi, A.; Baccarani, G. “TCAD analysis of the leakage current and breakdown versus temperature of GaN-on-Silicon vertical structures”, Solid-State Electronics, Vol. 115, n.8, pp. 173-178 (2016).

IUNET	Zanoni, E.; Meneghini, M.; Chini, A.; Marcon, D.; Meneghesso, G., "AlGaIn/GaN-Based HEMTs Failure Physics and Reliability: Mechanisms Affecting Gate Edge and Schottky Junction", INVITED IEEE Transactions on Electron Devices, Vol. 60, no. 10, pp. 3119 – 3131 (2013).
IUNET	M. Meneghini, R. Silvestri, S. Dalcanale, D. Bisi, E. Zanoni, G. Meneghesso, P. Vanmeerbeek, A. Banerjee, P. Moens "Temperature-Dependent Dynamic Ron in GaN-Based MIS-HEMTs: Role of Surface Traps and Buffer Leakage" IEEE Transactions on Electron Devices, vol.62, no.3, pp.782-787 (2015).
IUNET	Crupi, F., Magnone, P., Strangio, S., Iucolano, F., Meneghesso, G. "Low frequency noise and gate bias instability in normally off AlGaIn/GaN HEMTs", IEEE Transactions on Electron Devices, Volume 63, Issue 5, Pages 2219-2222 (2016).
IUNET	Scarpino, M., Gupta, S., Lin, D., Alian, A., Crupi, F., Collaert, N., Thean, A., Simoen, E. "Border traps in InGaAs nMOSFETs assessed by low-frequency noise" IEEE Electron Device Letters 35 (7), 6819797, pp. 720-722 (2014).
IUNET	Giorgio Spiazzi; Simone Buso " Analysis of the Interleaved Isolated Boost Converter With Coupled Inductors ", IEEE Transactions on Industrial Electronics, 62, pp. 4481 - 4491 (2015).
IUNET	Francesco Sichirolo; J. Marcos Alonso; Giorgio Spiazzi "A Novel Double Integrated Buck Offline Power Supply for Solid-State Lighting Applications", IEEE Transactions on Industry Applications, 51, pp. 1268 – 1276 (2015).
IUNET	R. Bottura and A. Borghetti, "Simulation of the volt/var control in distribution feeders by means of a networked multi-agent system," IEEE Trans. Ind. Informatics, vol. 10, no. 4, pp. 2340–2353, 2014.
IUNET	A. D'Elia, F. Viola, F. Montori, M. Di Felice, L. Bedogni, L. Bononi, A. Borghetti, P. Azzoni, P. Bellavista, D. Tarchi, R. Mock, and T. S. Cinotti, "Impact of Interdisciplinary Research on Planning, Running, and Managing Electromobility as a Smart Grid Extension," IEEE Access, vol. 3, pp. 2281–2305, 2015.
ST-CNR	A. Frazzetto, F. Giannazzo, P. Fiorenza, V. Raineri, F. Roccaforte, <i>Limiting mechanism of inversion channel mobility in Al-implanted lateral 4H-SiC metal-oxide semiconductor field-effect transistors</i> , Appl. Phys. Lett. 99 , (2011) 072117.
ST-CNR	L.K. Swanson, P. Fiorenza, F. Giannazzo, A. Frazzetto, F. Roccaforte, <i>Correlating macroscopic and nanoscale electrical modifications of SiO₂/4H-SiC interfaces upon post-oxidation-annealing in N₂O and POCl₃</i> , Appl. Phys. Lett. 101 , (2012) art. N°. 193501.
ST-CNR	P. Fiorenza, F. Giannazzo, M. Vivona, A. La Magna, F. Roccaforte, <i>SiO₂/4H-SiC interface doping during post-deposition-annealing of the oxide in N₂O or POCl₃</i> , Appl. Phys. Lett. 103 , (2013) 153508.
ST-CNR	F. Roccaforte, P. Fiorenza, G. Greco, M. Vivona, R. Lo Nigro, F. Giannazzo, A. Patti, M. Saggio, <i>Recent advances on dielectrics technology for SiC and GaN power devices</i> , Appl. Surf. Sci. 301 (2014), 9-18.

ST-CNR	P. Fiorenza, A. Frazzetto, A. Guarnera, M. Saggio, F. Roccaforte, <i>Fowler-Nordheim tunneling at SiO₂/4H-SiC interfaces in metal-oxide-semiconductor field effect transistors</i> , Appl. Phys. Lett. 105 , (2014) 142108.
UNIME	Caddemi, A., Crupi, G., Fazio, E., Patanè, S., Salvo, G., “A complete microwave characterization of GaAs HEMTs under optical illumination”, Microwave Review 19, Issue 2, pp. 112-118 (2013)
UNIME	C. Triolo, S. Patanè, M. Mazzeo, S. Gambino, G. Gigli, and M. Allegrini, “ Pure optical nano-writing on light-switchable spiropyrans/merocyanine thin film”, Optic Express, 22, Issue 1, pp. 283-288 (2014).
UNIME	A. Caddemi, G. Crupi, E. Fazio, S. Patanè, and G. Salvo, “Remarks of an extensive investigation on the microwave HEMT behavior under illumination”, IEEE Microwave and Wireless Components Letters, vol. 24, no 2, pp. 102-104, (2014)
UNIME	S. Stelitano, S. Savasta, S. Patané, “Designing light emission with multiple organic based microcavities”, Thin Solid Films (2014)
UNIME	M. Mazzeo, A. Genco, S. Gambino, D. Ballarini, F. Mangione, O. Di Stefano, S. Patanè, S. Savasta, D. Sanvitto and G. Gigli “Ultrastrong light-matter coupling in electrically doped microcavity organic light emitting diodes” , App. Phys. Lett, 104 , 233303 (2014).
UNIME	F. Tantussi, F. Fuso , M. Allegrini, N. Micali, I. Occhiuto, L. Monsù Scolaro, S. Patanè, “Linear and Circular Dichroism in Porphyrin J-Aggregates Probed by Polarization Modulated Scanning Near-Field Optical Microscopy“, Nanoscale , 6 , 10874-10878 (2014)
UNIME	S. Gambino, M. Mazzeo A. Genco, O. Di Stefano, S. Savasta, S. Patanè, D. Ballarini, F. Mangione, G. Lerario, D. Sanvitto, G. Gigli, "Exploring light-matter interaction phenomena under ultrastrong coupling regime", ACS Photonics, 1, 1042, (2014)
UNIME	A. Cacciola, C. Triolo, O. Di Stefano, A. Genco, M. Mazzeo, R. Saija, S. Patanè, S. Savasta, “Subdiffraction Light Concentration by J-Aggregate Nanostructures”, <i>ACS Photonics</i> , (2015)
UNIME	N. Boukourt, B. Hadri, A. Caddemi, S. Patanè, G. Crupi, “Simulation of Nanoscale SOI n-FinFET at 8 nm Gate Length in 3D Using ATLAS SILVACO”, Trans. Electr. Electron. Mater., 16, 156-161 (2015)
UNIME	S. Gambino, A. Genco, G. Accorsi, O. Di Stefano, S. Savasta, S. Patanè, G. Gigli, M. Mazzeo, Ultrastrong light-matter coupling in electroluminescent organic microcavities, Applied Materials Today 1 (2015) 33–36
UNIME	C. Triolo, E. Fazio, F. Neri, A.M. Mezzasalma, S. Trusso, S. Patanè, Correlation between structural and electrical properties of PLD prepared ZnO thin films used as a photodetector material, Appl. Surf. Sci. 359 (2015) 266–271

UNIME	N. Boukortt, B. Hadri, A. Caddemi, G. Crupi, and S. Patanè, “Electrical Characteristics of 8-nm SOI n-FinFETs” <i>Silicon</i> 8, 497-503 (2016).
UNIME	N. Boukortt, B. Hadri, and S. Patanè, “Effects of high-k dielectric materials on electrical characteristics of DG n-FinFETs” <i>International Journal of Computer Applications (0975 – 8887) Volume 139 – No.10</i> , (2016).
UNIME	S Russo, A Testa, S De Caro, T Scimone, S Panarello, S Patanè, G Scelba, G Scarcella, Reliability “Assessment of Power MOSFETs Working in Avalanche Mode Based on a Thermal Strain Direct Measurement Approach” <i>IEEE Transaction on Industry Applications</i> , vol. 52, n. 2, 1688, (2016)
UNIME	N. Boukortt, B. Hadri, A. Caddemi, G. Crupi, and S. Patanè, “The temperature dependence of electrical parameters of TG SOI n-FinFET” <i>Trans. Electr. Electron. Mater.</i> (Accepted for publication).
UNIME	Russo S., Testa A., De Caro S., Scimone T., Panarello S., Patane S., Scelba G., Scarcella G. “ <i>Reliability Assessment of Power MOSFETs Working in Avalanche Mode Based on a Thermal Strain Direct Measurement Approach</i> ”. <i>IEEE TRANSACTIONS ON INDUSTRY APPLICATIONS</i> , vol. 52, p. 1688-1697, ISSN: 0093-9994, doi: 10.1109/TIA.2015.2500890.
UNIME	Montanini R., Scimone T., De Caro S., Testa A. “ <i>Full-frame infrared thermal imaging of power electronics devices by means of multiple time-delayed measurements</i> ”. <i>QUANTITATIVE INFRA RED THERMOGRAPHY JOURNAL</i> , vol. 12, p. 149-161, ISSN: 1768-6733, doi: 10.1080/17686733.2015.1039292
UNIME	Testa A., De Caro S., Russo S.” <i>A Reliability Model for Power MOSFETs Working in Avalanche Mode Based on an Experimental Temperature Distribution Analysis</i> ”. <i>IEEE TRANSACTIONS ON POWER ELECTRONICS</i> , vol. 27, p. 3093-3100, ISSN: 0885-8993, doi: 10.1109/TPEL.2011.2177279
UNIME	Testa A., De Caro S., Russo S., Patti D., Torrisi L. “ <i>High Temperature Long Term Stability of SiC Schottky Diodes</i> ”. <i>MICROELECTRONICS RELIABILITY</i> , vol. 51, p. 1778-1782, ISSN: 0026-2714, doi: 10.1016/j.microrel.2011.07.026

UNIME	Testa A., De Caro S., Panarello S., Patane S., Russo S., Patti D, Poma S., Letor R.. “ <i>Reliability of planar, Super-Junction and trench low voltage power MOSFETs</i> ”. MICROELECTRONICS RELIABILITY, vol. 50, p. 1789-1795, ISSN: 0026-2714, doi: 10.1016/j.microrel.2010.07.042
UNIME	Consoli A., Cacciato M., Scarcella G., Testa A. . “ <i>Compact reliable efficiency - A multiphase dc/dc converter for automotive dual-voltage power systems</i> ”. IEEE INDUSTRY APPLICATIONS MAGAZINE, vol. 10, p. 35-42, ISSN: 1077-2618, doi: 10.1109/MIA.2004.1353045
UNIME	Consoli A., Gennaro F., Testa A., Consentino G., Frisina F., Letor R., Magri A. “ <i>Thermal instability of low voltage power-MOSFET's</i> ”. IEEE TRANSACTIONS ON POWER ELECTRONICS, vol. 15, p. 575-581, ISSN: 0885-8993.
WÜRTH	D. Dinulovic, M. Kaiser, A. Gerfer, O. Opitz, M. C. Wurz, L. Rissing, “ <i>Thin-Film Microtransformer for High Frequency Power Applications</i> ”, EPJ Web of Conferences 75, 06006 (2014)
WÜRTH	D. Dinulovic, M. Haug, A. Gerfer, M. Wens, J. Thone, “ <i>On-Chip High Performance Magnetics for Point-of-Load High-Frequency DC-DC Converters</i> ” (presented at APEC2016 Conference)
APOJEE	" <i>Scalable and Modular Test Bench Approach for Validation of Power Electronics Components</i> " – M. Lteif – ECPE – 2014
UNIPA-DEIM	G. Ala, C.G. Giaconia , G. Giglia, M. C. Di Piazza and G. Vitale, "Design and Performance Evaluation of a High Power-Density EMI Filter for PWM Inverter-Fed Induction-Motor Drives," in <i>IEEE Transactions on Industry Applications</i> , vol. 52, no. 3, pp. 2397-2404, May-June 2016. doi: 10.1109/TIA.2016.2518129
UNIPA-DEIM	G. Ala, M.C. Di Piazza, C. G. Giaconia , G. Giglia, M. Luna, G. Vitale, P. Zanchetta, “Computer Aided Optimal Design of High Power Density EMI Filters”, 16th International Conference on Environment and Electrical Engineering (EEEIC), Florence, Italy, 7-10 June 2016.
UNIPA-DEIM	Vigni, V.L.; Manna, D.L.; Sanseverino, E.R.; di Dio, V.; Romano, P.; di Buono, P.; Pinto, M.; Miceli, R.; Giaconia, C.G. , “Proof of Concept of an Irradiance Estimation System for Reconfigurable Photovoltaic Arrays”. <i>Energies</i> 2015, 8, 6641-6657. doi:10.3390/en8076641

UNIPA-DEIM	N. Galioto, F. Lo Bue, D. Rizzo, L. Mistretta, C. G. Giaconia , “A Novel Wireless Sensor Network for Electric Power Metering”, in Vol. 289 of the series Lecture Notes in Electrical Engineering (ISBN 978-3-319-04370-8) pp.121-131, June 2014 doi: 10.1007/978-3-319-04370-8_11
DAC	V.Scordamaglia, M.Mattei, “Task Priority Approach to the Coordinated Control of a Team of Flying Vehicles in the Presence of Obstacles” IET Control Theory & Applications, doi: 10.1049/iet-cta.2010.0742, (13) , pp. 2103-2110. 2013.
DAC	L. Blasi, S. Barbato, M.Mattei, A particle swarm approach for flight path optimization in a constrained environment, Aerospace, Science and Technology, 26 (1), pp.128-137, 2013, DOI information: 10.1016/j.ast.2012.02.021
DAC	G. Franzè, A. Furfaro, M.Mattei, V. Scordamaglia, “A SAFE SUPERVISORY FLIGHT CONTROL SCHEME IN THE PRESENCE OF CONSTRAINTS AND ANOMALIES,” Int. J. Appl. Math. Comput. Sci., 2015, Vol. 25, No. 1, 39–51, DOI: 10.1515/amcs-2015-0003
DAC	Di Francesco G., Mattei M., “Modeling and Incremental Nonlinear Dynamic Inversion Control of a Novel Tilt Rotor UAV” 2016, JOURNAL OF AIRCRAFT, volume 53, doi 10.2514/1.C033183, pages = {73--86}
DAC	Pascarella D and Venticinque S and Aversa R and Mattei M and Blasi L, Parallel and Distributed Computing for UAVs Trajectory Planning, 2015, JOURNAL OF AMBIENT INTELLIGENCE AND HUMANIZED COMPUTING, 10.1007/s12652-015-0282-y, pp. 1-10
DAC	Pascarella D and Venticinque S and Aversa R and Mattei M and Blasi L, A Parallel and a Distributed Implementation of the Core Paths Graph Algorithm, 2015, Springer International Publishing Switzerland, BERLIN, HEIDELBERG, STUDIES IN COMPUTATIONAL INTELLIGENCE, volume 570, doi 10.1007/978-3-319-10422-5_43, pages 417--426
DAC	Ariola M., Corraro F., Mattei M., Notaro I., An SFDI observer-based scheme for a general aviation aircraft, 2nd, International Conference on Control and Fault-Tolerant, Systems, SysTol’13, Nice, France on October, 911, 2013. Digital Object Identifier: 10.1109/SysTol.2013.6693930 Page(s): 152 – 157, ISBN: 978-1-4799-2855-2

DAC	<p>Franzè G., Furfaro A., Mattei M., Scordamaglia V., An hybrid command governor supervisory scheme for flight control systems subject to unpredictable anomalies -Fault Detection, Supervision and Safety for Aircraft and Spacecraft Systems, 2nd, International Conference on Control and Fault-Tolerant, Systems, SysTol'13, Nice, France on October, 911, 2013, Digital Object Identifier: 10.1109/SysTol.2013.6693894, Publication Year: 2013 , Page(s): 31 – 36, ISBN: 978-1-4799-2855-2.</p>
DAC	<p>Franzè G., Mattei M., Ollio L., Scordamaglia V., A Receding Horizon Control scheme with partial state measurements: Control Augmentation of a flexible UAV, 2nd, International Conference on Control and Fault-Tolerant, Systems, SysTol'13, Nice, France on October, 911, 2013, Digital Object Identifier: 10.1109/SysTol.2013.6693921 Publication Year: 2013 , Page(s): 158 – 163, ISBN: 978-1-4799-2855-2</p>
DAC	<p>Franzè G., Furfaro A., Mattei M., Scordamaglia V., Embedding Norm-Bounded Model Predictive Control, Allocation strategy for the High Altitude Performance, Demonstrator (HAPD) Aircraft, 52nd IEEE Conference on Decision and Control, Firenze, Italy on December 10-13, 2013.</p>
DAC	<p>Franzè, G., Mattei, M., Scordamaglia, V., Embedding norm-bounded model predictive control allocation strategy for the High Altitude Performance Demonstrator (HAPD) aircraft (2013) Proceedings of the IEEE Conference on Decision and Control, art. no. 6760903, pp. 6409-6414. ISSN: 01912216, ISBN: 9781467357173, DOI: 10.1109/CDC.2013.6760903</p>
DAC	<p>Franzé, G., Mattei, M., Scordamaglia, V. “Constrained predictive strategies for flight control systems” (2014) 29th Congress of the International Council of the Aeronautical Sciences, ICAS 2014, pp.1.6., ISBN: 3932182804</p>
DAC	<p>Notaro, I., Ariola, M., D'Amato, E., Mattei, M. HW VS SW sensor redundancy: Fault detection and isolation observer based approaches for inertial measurement units (2014) 29th Congress of the International Council of the Aeronautical Sciences, ICAS 2014, pp.1-6. ISBN: 3932182804</p>
DAC	<p>Di Francesco, G., Scapatucci, G., Mattei, M. Transition control and redundancy management for a tilt rotor UAV using genetic algorithms (2014) 29th Congress of the International Council of the Aeronautical Sciences, ICAS 2014, pp.1-6. ISBN: 3932182804</p>

DAC	Franzè, G., Mattei, M., Ollio, L., Scordamaglia, V., Tedesco, F. A reconfigurable aircraft control scheme based on an hybrid Command Governor supervisory approach (2014) Proceedings of the American Control Conference, art. no. 6859230, pp. 1273-1278. ISSN: 07431619, ISBN: 9781479932726, DOI: 10.1109/ACC.2014.6859230
DAC	D'Amato E and Di Francesco G and Notaro I and Tartaglione G and Mattei M, Nonlinear dynamic inversion and neural networks for a tilt tri-rotor UAV, 2015, Vol.48, IFAC Proceedings Volumes (IFAC-PapersOnline), doi 10.1016/j.ifacol.2015.08.077, 162—167, 2015
DAC	Di Francesco Gabriele and D'Amato Egi and Mattei Massimiliano, INDI control with direct lift for a tilt rotor UAV, 2015, Vol 48, IFAC Proceedings Volumes (IFAC-PapersOnline), doi 10.1016/j.ifacol.2015.08.076}, pp 156-161, 2015
DAC	D'Amato E and Notaro I and Mattei M and Tartaglione G, Attitude and position estimation for an UAV swarm using consensus Kalman filtering, year 2015, 2nd IEEE International Workshop on Metrology for Aerospace, MetroAeroSpace 2015 – Proceedings, 10.1109/MetroAeroSpace.2015.7180711, pp., 519—524, 2015
DAC	E. D'Amato, S. Bassolillo, L. Blasi, M. Mattei, G. Scapatucci - Ant Colony Algorithm for Path Planning of a Quadrotor UAV, XXII convegno AIDAA, Napoli, Settembre, 2013
workshop FEPPCON 2015	Power-Semiconductor Devices and Components for New Power Converter Developments, Juan Carlos Balda, Alan Mantooth

4.2. Third parties involved in the project (including use of third party resources)

DTSMNS

Does the participant plan to subcontract certain tasks (please note that core tasks of the project should not be sub-contracted)	N
Does the participant envisage that part of its work is performed by linked third parties	Y
<p>DTSMNS is planning to perform part of the activities by the linked third parties UNIPA. UNIPA (Università di Palermo) is a founder member of DTSMNS.</p> <p>The University of Palermo (UPA – www.unipa.it) is one of the largest public Universities in Italy (more than 50.000 students) and represents a consolidated cultural, scientific and teaching presence in central-western Sicily. Its 5 Schools and 20 Departments cover the most important domains of contemporary scientific and technological knowledge. About 122 courses (first and second cycle) are yearly offered as well as 44 master and specialization and several PhD courses, targeted to the training of specific professional figures, often in cooperation with external institutions and companies. The University General Hospital is a local health corporation that works in synergy with the School of Medicine. There is a closed link between UPA and the labor market: final year students experience practice periods within public or private companies and agencies.</p> <p>UPA has 20 Departments, where research is carried out toward all the main questions posed by nature, science and society. From Information Technology to Biology, from Mathematics to Medicine, to Social Sciences and Preservation of Cultural Heritage, the University works to make its contribution of innovation and progress to the international scientific community and the world of production.</p> <p>Successful technological transfer implies the full synergy of innovative technologies, scientific expertise, production systems and processes. In order to contribute to achieve this goal, the University of Palermo has set up a network of University labs (UniNetLab) for testing and transferring new technologies to SMEs as well as the generation of a start-up incubator, named ConsorzioArca.</p> <p>UNIPA will be involved in the WP2b (with the UNIPA Department DEIM), in the WP6b (with the UNIPA Department DEIM), and in the WP7b (with the UNIPA Departments DIID and DICAM).</p> <p>DEIM (Department of Energy, Information engineering and mathematical Model) is one of the largest Departments of the University of Palermo and comprises several research areas: Electrical Engineering, Electronics Engineering, Telecommunication Engineering and Energy related fields of research. Two PhD programs are also offered on ICT and Energy respectively. DEIM covers a large spectrum of research interests, carried out under the sponsorship of the Italian Research Agencies (MIUR, CNR, ASI, AEI), European Research Agencies (ESA), and several private organizations. The researchers that will participate to the ASTONISH project are part of the LOOX Lab and of the Digital Electronics System Lab. People from these groups have a quite large project expertise, as documented by the participation to several projects (ARTEMIS/JU – HIGH PROFILE, FP7 - BeyWatch, ITEA – RTIPA, POLLENS, IST SUITED, FIFTH, ICEBERGS), national FIRB and PRIN projects. The major research topics addressed are: Design and Performance Evaluation of Embedded system for bio-applications, automotive and TLC purposes, Wireless Networks, Programmable and Active Networks, Optical devices characterization, UV/VIS/NIR spectroscopy systems. The results have produced a large number of papers in archival journals and international conferences, and several prototypes. Well-established cooperation activities involve foreign Universities (Washington University of St Louis, Columbia University, STANFORD University) and several National Organizations (CNR, MIUR, TILAB, ITALTEL, ERICSSON, TIM, ALCATEL, NORTEL, STM, Phillips, EDF, Telefonica I&D...).</p> <p>DIID Department and DICAM Department are focussed the one on Digital & Industrial Innovation, the other on Civil and Aerospatial Material.</p>	

Since 1964 Aerospace Engineering is a fundamental institution into University of Palermo. At the present its students come either from Sicily and from the Mediterranean Area .

Research activities are related to the whole field of Aeronautical Sciences and range from Aerospace Materials and Structures to Aerodynamics, System Theory, Flight Dynamics, Aircraft Design, Engines, and Avionics.

Researchers are involved into several national and international projects and cooperate with both the most important Aerospace Industries (AIRBUS, LEONARDO, AGUSTA WESTLAND , AIRBUS Defence and Space) and Aeronautical Regulation Agencies like ENAC. They are esteemed into the Aerospace International Community and cooperate with various Research Centers and Universities. In particular they work with the State Marine Technical University(SMTU) of Saint Petersburg , the Imperial College of London, the Northwestern University, the University of Bologna, University of Naples, University of Salento, the Italian Centre of Aerospace Research (CIRA). Therefore they has gained a lot of experiences in the field of Smart materials and devices, Unmanned Aerial Systems (UAS or drones) and Aerospace Systems.

UNIPA key personnel involved (DEIM Department)

Prof. Giuseppe Costantino Giaconia (male): MS(89) and PhD(94) on Electronic Engineering at the University of Palermo (IT). Marie-Curie Fellow within Glasgow University Nanotechnology Lab (96-99). Co-authors of over 100 scientific papers; Tutor of 6 PhD students and over 100 final thesis (MS&BS), he routinely teaches Digital Electronics and Microprocessors as Associate Professor and he is currently the principal investigator of the ESDP Lab (Programmable Digital Electronics Systems) within the University of Palermo. His research has several areas of interest: Optoelectronics and Nanotechnologies and Digital Electronics Systems.

- Deep knowledge of microprocessor based hardware architectures, design and implementation of programmable digital systems such as microcontroller and FPGA (Field Programmable Gate Array) through VHDL. Real-time computer control of laboratory equipment.
- Wireless local area network and Internet of Things applications as well as combustion engines micro-control are among the most analysed target applications.
- Micro- and nano-lithographic processes and related technologies: coating of 2-D and 3-D samples with resist or metalorganic compounds by spinning, spraying and dipping deposition techniques,
- optical and e-beam exposure, wet etching and lift-off processes, thin film fabrication by physical vapour deposition, sputtering deposition, deep knowledge of design, fabrication and general operations in clean room environments.
- Mask fabrication and generic substrate patterning by laser direct writing, for several applications: diffractive and integrated optics, microwave passive planar devices, silicon micromachining, non-conventional 3-D structures.

He is densely involved in several research projects both at national and European level. He hold a few international patents and has pioneered three hi-tech spin-off companies. He is now working within the Department of Energy, Information engineering and math Models (DEIM) of the University of Palermo as Associate Professor.

Prof. Giuseppe Lullo (male): MS (1990) and PhD (1995) on Electronic Engineering from the University of Palermo, Italy. Visiting Research Fellow (1993-94) at the Optoelectronics Lab of Glasgow University, UK. Visiting Scientist (1998) at the Dept. of Electronics and Computer Science of M.I.T., Cambridge, U.S.A.. Reasercher (1999) and Associate Professor of Electronics (2005) at the University of Palermo, Italy, during the years he has taught several courses on Electronic Devices, Electronics Basics, Electronics for Telecommunications, Analogue Electronics, Applied Electronics.

He is currently the principal investigator of the Power Applications Laboratory within the University of Palermo.

His research activities cover several areas:

- Design and fabrication of optoelectronics and electronics devices.

- Design of mixed-signals electronic systems and custom optical systems for the realization of laser direct writing equipments for microlithographic processes.
- Design of custom electronic systems for controlling X-ray satellite telescopes.
- Design of Power Electronics systems.

He holds a patent on an optical diffractometer. He also founded and co-managed for twenty years a high-tech spin-off company.

He is a Member of IEEE and of INAF (Italian National Institute for Astrophysics)

UNIPA key personnel involved (DIID / DICAM Departments):

Prof. Caterina Grillo (female): she is professor of Flight Dynamics and Flight Mechanics and Coordinator of the Master Degree Program "Aerospace Engineering" of the University of Palermo. Present research activities are related to Unmanned Aerial Systems (UAS) and Wing In Ground Effect Vehicles (WIG's). In particular she is developing researches related to: Collision Avoidance, Guidance Navigation and Control, System Identification from Flight Tests.

She is member of the Editorial Board of "Automatic Control in Aerospace" and referee of various international Aeronautical Journal.

She has presented Keynote Lectures at the Conferences of the Council of European Aerospace Society (CEAS), and at the FAST and SuperFAST Conferences.

She cooperates with Airbus Defense and Space (Manchen), the State Marine Technical University (SMTU) of Saint Petersburg, the Warsaw University of Technology :Faculty of Power and Aeronautical Engineering, the University of Belo Horizonte, the Parthenope University (Naples), the University of Bologna.

She is member of the Scientific Board of various Aeronautical projects in the contest of FP7 (e.g. SHERPA).

She has been Scientific coordinator of research activities developed with the financial support of the Italian University and Research Ministry (MIUR), the Sicily Region, and some Aerospace Industries.

Prof. Alberto Milazzo (male): he is professor of Aerospace Structures and Construction, has held and holds courses in Aerospace Systems, Aerospace Design and Structures at the University of Palermo. His research activity was focused on the development of numerical and analytical formulations and models, relating to typical problems of advanced aerospace applications. In this context, he proposed and investigated original and alternative models and methods, mainly developed in the framework of the boundary element method and the finite element method, as modern and efficient theoretical-numerical approaches to the solution of engineering problems. He authored more than 150 papers published in international journals and/or presented at national and international conferences. He was involved as investigator and/or coordinator of several research projects funded by the Italian Ministry of Education and aerospace industries. He serves as reviewer for several international journals and he is member of international conferences scientific committees.

Dr. Ivano Benedetti (male): he is, since 2008, Assistant Professor of Aerospace Structures at the University of Palermo (Italy).

Between October 2015 and March 2016 he was Fulbright Research Scholar at the McCormick School of Engineering of the Northwestern University, Evanston, IL, USA, where he worked on computational modelling of bio-inspired nano-composites.

Between 2011 and 2013 he has been a Marie Curie Intra-European Fellow at the Department of Aeronautics of Imperial College London, where he worked on a three-dimensional multiscale model for intergranular degradation and failure in polycrystalline materials.

In 2008, he obtained the PhD Degree in Aerospace Engineering from the University of Pisa, Italy.

He has authored overall around 60 scientific papers (papers, chapters, proceedings) and served as referee for several international journals. His main research interests revolve around computational mechanics of materials, solids and structures.

Allocation of Person-months among the DTSMNS partners:						
	WP1a	WP1b	WP2b	WP6b	WP7b	TOTAL
DTSMNS	43	3		10	2	58
UNIPA (DEIM)			4	31	4	39
UNIPA (DIID)				15	5	20
UNIPA (DICAM)				15	5	20
TOTAL-DTSMNS	43	3	4	71	16	137
Does the participant envisage the use of contributions in kind provided by third parties (Articles 11 and 12 of the General Model Grant Agreement)						N

VSCM

Does the participant plan to subcontract certain tasks (please note that core tasks of the project should not be sub-contracted)	Y
<i>If yes, please describe and justify the tasks to be subcontracted</i> Subcontr. to GEEDS for validation (EMC 30 days OBC, 24 days DCDC), and for SW development and tests (Egypt), simulation cost 61.158,4€, 65.698€. Boards layout (20 powerboard + 30 days control board DCDC, 90 days OBC ctrl board, main board, filterboard @90 €/hrs), simulation costs 36000€, 64800€. Thermal simulation, fluidic simulation, magnetic simulation, mechanical simulation-vibration (30 days OBC of simulation @90€/hrs 21.600€ , 40 days DCDC of simulation @90€/hrs 28.800€. Total subcontracting 278.056,4€	
Does the participant envisage that part of its work is performed by linked third parties	N
Does the participant envisage the use of contributions in kind provided by third parties (Articles 11 and 12 of the General Model Grant Agreement)	N

IUNET

Does the participant plan to subcontract certain tasks (please note that core tasks of the project should not be sub-contracted)	N
Does the participant envisage that part of its work is performed by linked third parties	Y
<p>The “Consorzio Nazionale Interuniversitario per la Nanoelettronica” (IUNET, Italian Universities Nano-Electronics Team) is a non-profit, private organization, aimed at leading and coordinating the efforts of the major Italian university teams in the field of silicon-based nano-electronic device modelling and characterization. Current members of IUNET are the Universities of Bologna, Calabria, Ferrara, Modena e Reggio Emilia, Padova, Pisa, Roma “Sapienza”, Udine and the Politecnico di Milano. As such IUNET qualifies as “beneficiary” and the contributing universities as “linked third parties” under the definition given in Article 14 of the “H2020 Annotated Model Grant Agreement”.</p> <p>The partners of IUNET involved in WInSiC4AP are the following:</p> <ul style="list-style-type: none"> • Università di Bologna • Università della Calabria 	

• Università di Padova.

Università di Bologna will contribute to the advanced device modeling and 2D / 3D device simulations of SiC-based devices with special focus on parasitic phenomena and breakdown behavior, and will participate to the definition of the application requirements and to the implementation of intelligent power switches and portable EV battery chargers.

Università della Calabria will contribute to the understanding of parasitic phenomena in Power SiC devices (trapping, gate leakage, drain leakage ...) in order to identify technological countermeasure. Bias temperature instability (BTI) and noise measurements will be performed to evaluate the material defectiveness and its impact to the device performance.

Università di Padova will contribute with the identification of device failure modes and mechanisms through state-of-the-art characterization techniques and to the realization of a test circuit capable of highlight the device performance in real operating conditions.

The specific competencies testified by the very large number of relevant papers published in international journals, the long-standing collaboration with leading industries in the field and the extremely significant recognition at international level of all the involved team members, as it can be deduced by their CVs. Joining the research teams by enforcing collaborations between the university research groups allows to exploit their complementarities and allows to work effectively in interdisciplinary topics requiring the integration of competences in electronic circuit, system design, characterization and modelling of power systems as is the case of WInSiC4AP.

As “linked third party” Università di Bologna, Università della Calabria and Università di Padova will carry out the work and will claim their own costs for implementing the tasks.

Allocation of Person-months among the IUNET partners:

IUNET	WP2a	WP5a	WP6a	WP7a	TOTAL
Università di Bologna	1	37.5	6	3.5	48
Università della Calabria	0	28	0	2	30
Università di Padova	0	55.5	0	2.5	58
TOTAL-IUNET	1	121	6	8	136

Does the participant envisage the use of contributions in kind provided by third parties (Articles 11 and 12 of the General Model Grant Agreement)	N
<i>If yes, please describe the third party and their contributions</i>	

LUH

Does the participant plan to subcontract certain tasks (please note that core tasks of the project should not be sub-contracted)	Y
<i>If yes, please describe and justify the tasks to be subcontracted</i>	
Laser cutting of soft magnetic materials (material thickness >10 µm and < 2 mm): to minimize the thermal impact a laser with ps-pulses are needed. Drilling and milling will be strong decrease the magnetic performance of the material. In previous work the process stability are checked for 5 µm and 50 µm thick foils.	
Does the participant envisage that part of its work is performed by linked third parties	N

Does the participant envisage the use of contributions in kind provided by third parties (Articles 11 and 12 of the General Model Grant Agreement)	N
--	---

ZODAERO

Does the participant plan to subcontract certain tasks (please note that core tasks of the project should not be sub-contracted)	Y
<p>WP6.a.2: ZODAERO will develop converter hardware and software on its own but will rely on specialized subcontractor for product architecture definition and converter preliminary design but mainly during detailed design phase. The subcontractor will then model converter control and electrical power chain to ensure that the converter regulation works fine according to sources, loads and electrical network characteristics during converter different operational modes. The subcontractor will also take into account real time constraints by generating software code from simulation and by testing it on ZODAERO or its own mock-up converter. During integration tests, the subcontractor will provide support to ZODAERO for functional validation and if necessary will adapt converter control laws. ZODAERO will rely on subcontracting to develop specific converter components package compatible with stringent aerospace environment constraints. This includes optimization of mechanical definition according to thermal and vibration performances. Total subcontracting: 338k€</p>	
Does the participant envisage that part of its work is performed by linked third parties ⁸	N
Does the participant envisage the use of contributions in kind provided by third parties (Articles 11 and 12 of the General Model Grant Agreement)	N

APOJEE

Does the participant plan to subcontract certain tasks (please note that core tasks of the project should not be sub-contracted)	Y
<p><i>If yes, please describe and justify the tasks to be subcontracted</i> There is only one subcontractor related to the total amount and it will be involved in the WP6a. The subcontractor will work on software development for monitoring the global test bench security level and test bench performance. These software are divided into two main level :</p> <p>FPGA level</p> <ul style="list-style-type: none"> - Set the communication Ethercat in the FPGA board PXIe-6592R - Parametrization and monitoring of test bench modules - AC and DC current measurement - Calculation loop for AC and DC instructions - AC and DC instruction transmission (target is 17µs) - Validation of the time cycle <p>Real time level (Veristand)</p> <ul style="list-style-type: none"> - Machine model compilation (supplied by APOJEE or customer of the bench) - Insertion in the software the tuning and monitoring of modules 	

⁸ A third party that is an affiliated entity or has a legal link to a participant implying a collaboration not limited to the action. (Article 14 of the Model Grant Agreement).

<ul style="list-style-type: none"> - Building a “custom device Master” for interfacing theoretical model and regulation loop - Battery model integration - Building a Human Machine Interface for monitoring - Reading and generating instructions from data set (torque/speed related to time). 	
Does the participant envisage that part of its work is performed by linked third parties	N
Does the participant envisage the use of contributions in kind provided by third parties (Articles 11 and 12 of the General Model Grant Agreement)	N

APSI3D

Does the participant plan to subcontract certain tasks (please note that core tasks of the project should not be sub-contracted)	Y
<i>If yes, please describe and justify the tasks to be subcontracted</i> CEA thermal & fluidic measurement subcontracting 80.000€, Primes operations subcontracting 72.000€.	
aPSI3D is dealing here with Mechatronics. As a consequence, cross functional expertise must work together. <ul style="list-style-type: none"> a) For each configuration, the cooling distribution across the dice must be assessed closely, coupling potentially unbalanced heat dissipation from the paralleled dice and the cooling fluid dynamic properties vs. local temperature b) Material contribution must be assessed c) Electro-thermal coupled simulations are considered necessary at this stage d) Physical and electrical characterisation of partially assembled modules will be completed. 	
Does the participant envisage that part of its work is performed by linked third parties	N
Does the participant envisage the use of contributions in kind provided by third parties (Articles 11 and 12 of the General Model Grant Agreement)	N

UNITOU

Does the participant plan to subcontract certain tasks (please note that core tasks of the project should not be sub-contracted)	Y
<i>If yes, please describe and justify the tasks to be subcontracted</i> UNITOU plans to use 5k€ to achieve physical measurements (for example SIMS) not available in Tours.	
Does the participant envisage that part of its work is performed by linked third parties	N
Does the participant envisage the use of contributions in kind provided by third parties (Articles 11 and 12 of the General Model Grant Agreement)	N

ED

Does the participant plan to subcontract certain tasks (please note that core tasks of the project should not be sub-contracted)	Y
<i>If yes, please describe and justify the tasks to be subcontracted</i> Subcontracting costs are referred to the external services necessary to support ED in the development of a lab-level bidirectional power converter based on SIC power modules and for the design validation, assembly and testing phases of the prototype. The specific subcontractor is Bitron S.p.a with which ED has already jointly worked for the design of a power convertor. The SIC power converter prototype of the project, so developed, will be Intellectual property of e-distribuzione.	
Does the participant envisage that part of its work is performed by linked third parties	N
Does the participant envisage the use of contributions in kind provided by third parties (Articles 11 and 12 of the General Model Grant Agreement)	N

DAC

Does the participant plan to subcontract certain tasks (please note that core tasks of the project should not be sub-contracted)	N
<i>If yes, please describe and justify the tasks to be subcontracted</i>	
Does the participant envisage that part of its work is performed by linked third parties ⁹	Y
<p><i>If yes, please describe the third party, the link of the participant to the third party, and describe and justify the foreseen tasks to be performed by the third party</i></p> <p>DAC is a consortium of many partners including large industries, research centers, universities, and other entities that are in turn consortia of SMEs. One of these SMEs consortia is CALTEC that is directly involved in the present project via its members REDAM and OMI providing person-power and taking care of the core technical aspects of the DAC participation in WInSiC4AP.</p> <p>OMI and REDAM participate to CALTEC Consortium (member of DAC) providing a complete technological offer (from design to manufacturing and testing) for both internal OEM activities and main aerospace companies worldwide (LEONARDO, Airbus, Antonov, Aerovodochody, ROLLSROYCE).</p> <p><u>REDAM</u> was founded in 2001 with the aim to fill the gap between industrial application and scientific knowledge. This mission is accomplished thanks to a wide multidisciplinary background:</p> <ul style="list-style-type: none"> • Applied Mathematics and Software Development • Computational Fluid Dynamics • Finite Element Methods in Structures • CAD Design • Manufacturing Technologies (CAM, High Speed Machining, NDI, Composites); • Tool and Prototyping <p><u>OMI</u> was founded in 1984 as a manufacturing center for aerospace components, now industrial partner of LEONARDO (Finmeccanica) on all the main programs, B787, F35, B767, A321, A380, C27, EFA and MBDA supplier of special technologies for equipment testing. During the years OMI started from CNC machining technologies up to, testing, tooling, automations and system design and manufacturing, recently developing APU turbine (Auxiliary Power Unit) for narrow body aircrafts.</p> <p>Even if tools, machines, jigs and fixtures for airframe manufacturing and maintenance are developed too from sizing, to design and manufacturing still remain core technologies, now CALTEC activities are focused on aircraft system and assembly applications (Military, Commercial, Business, VLA and UAV); CALTEC Consortium is also developing an UAV System based on innovative architecture, control technologies and power supply.</p> <p>Having both EN9100 third part Certification running form, REDAM applied to EASA DOA according to Part 21 (EASA Project 21J.610); DOA certification for design office is expected within</p>	

⁹ A third party that is an affiliated entity or has a legal link to a participant implying a collaboration not limited to the action. (Article 14 of the Model Grant Agreement).

June 2017, while OMI is going to apply to EASA Part 21 POA certification, for parts and system manufacturing.

Responsible for carrying out the proposed research and/or innovation activities is PhD Eng. M. Giuliani: he developed a remarkable experience in aerospace through several European and National Research Programs. Moreover, he has been in charge of REDAM Srl as the Chief Executive Officer for 16 years, after 10 years in management responsibility and research organisations; now he is general manager of CALTEC Consortium.

As such **DAC** qualifies as “beneficiary” and the contributing member of CALTEC (i.e. *REDAM* and *OMI*) as “linked third parties” under the definition given in Article 14 of the “H2020 Annotated Model Grant Agreement”.

As far as the role of CALTEC in WInSiC4AP is concerned, its main tasks are briefly listed below, highlighting the separate contributions of OMI and REDAM respectively (more details may be found in the WP description):

- **WP2b**: REDAM will develop the activities related to technical specification definition of the two demonstrators under DAC responsibility
- **WP6b**: REDAM and OMI will execute all technical contributions foreseen in the WP in terms of design, manufacturing, integration and testing the two demonstrators under DAC responsibility.

It is here clarified that the DAC Staff will be dedicated to management and high level activities (WP2b, WP6b), and dissemination/communication (WP7b)

As “linked third party”, CALTEC and its members Redam and OMI will carry out the work and will claim their own costs for implementing the tasks.

Allocation of Person-months between DAC and CALTEC:

	WP2b	WP6b	WP7b	TOTAL
DAC	3	6	18	27
CALTEC - REDAM	18	180	0	198
CALTEC - OMI	0	40	0	40
TOTAL-DAC	21	226	18	265

Does the participant envisage the use of contributions in kind provided by third parties (Articles 11 and 12 of the General Model Grant Agreement)

N

If yes, please describe the third party and their contributions

Section 5: Ethics and Security

5.1 Ethics

No Ethic issues.

5.2 Security¹⁰

Please indicate if your project will involve:

- activities or results raising security issues: NO
- 'EU-classified information' as background or results: NO

¹⁰ http://ec.europa.eu/research/participants/data/ref/h2020/mga/gga/h2020-mga-gga-multi_en.pdf

6 Publishable Summary

- Summary description of the project objectives

WInSiC4AP core objective is to contribute in developing reliable technology bricks for efficient and cost-effective applications addressing social challenges and market segments where Europe is a recognized global leader as well as automotive, avionics, railway.

- Description of the work to be performed

WInSiC4AP approach is to rely on the strength of vertical integration allowing optimization, technologies fitting application requirements, developing the full ecosystem and approach relevant issues as reliability in the full scope. That enhances the competitiveness of EU- Industries as well as TIER1 and TIER2 down to the value chain in a market context where other countries today, such as the USA or Japan, are advancing and new players accessing SiC enter in the market.

- Expected final results and demonstrators

New topologies and architecture will be developed for targeted application simulating operational environment, at laboratory level (TRL3-4), driving the needed and still missed technologies, components and demonstrators to fill the gap between current state of the art and the very high demanding specifications. In synthesis the outcome of the WInSiC4AP project will be the design and the demonstration of enhanced and ready for automotive, railway and avionic qualification SiC components driven by the following applications:

1. On Board battery Charger for PHEV or BEV
2. Isolated DC-DC Converter for HEV, BEV and FC
3. Intelligent Power Switch (IPS-RA):
High Voltage Power Converters (<10 kV) for embedded railway equipment's
4. Intelligent Power Switch (IPS-AA):
AC & DC Intelligent Power Switch (IPS) for power distribution in avionics at module and component levels.
5. High efficiency Bidirectional SiC-based Power Converter for V2G/V2H applications in a nano/microgrid scenario
6. Inverter for Avionics Applications
7. LiPo Interface for Aerospace
8. Engine Controller-Inverter for Aerospace

- Potential impact (including the socio-economic impact and the wider societal implications of the project)

WInSiC4AP framework has been built so that companies working in different domains (i.e. automotive car maker and TIER1-2 and avionics, railway and defence TIER1-TIER2) and in the vertical value chain (semiconductor suppliers, companies manufacturing inductors and capacitors) as well as academic entities and laboratories will collaborate to co-design solutions, solve problems and exchange know-how, such that unforeseen results may also emerge.

WInSiC4AP will be supported with synergy by ECSEL JU and ESI funding, with relevant economic and social impact envisage in a less development region of Union.

Societal and Economic impact is relevant as few percent of efficiency improvements in power conversion can lead to impressive energy saving effects.

Reliability, efficiency improvements, cost and size reductions, designed-and-manufactured-in-EU are the most relevant challenges addressed in the WInSiC4AP project that are expected to lead to a strong European supply chain for SiC converters for the addressed applications; the ambition of WInSiC4AP is to play a primary role towards excellence in Europe: first generations of profitable products and components, primary access to IPs for the relevant essential capabilities, competitiveness of manufacturing in Europe.

Relevant contact details

Coordinator contact person ing. Leoluca Liggio
Tel +39 335 632 51 79
Emails leoluca.liggio@distrettomicronano.it

Scientific Responsible ing. Antonio Imbruglia
Tel +39 340 666 5492
Emails antonio.imbruglia@st.com

Annex 1: ENAC Declaration of Interest



**Il Direttore Centrale
Regolazione Aerea**

ENAC

Protocollo del 19/09/2016

0095498/RAA

Gent.^{ma} Prof.ssa
Caterina Grillo
Professore Associato di Dinamica del Volo
Dipartimento di Ingegneria Chimica Gestionale Informatica Meccanica
(DICGM)
Università di Palermo
Viale delle Scienze Ed. 8
90128 Palermo

Oggetto: richiesta collaborazione progetto.

Con riferimento all'oggetto e a quanto espresso per le vie brevi, Le confermo l'interesse dell'ENAC, quale Ente regolatore del sistema, al progetto "Wide band gap INnovative SiC for Advanced Power".
In particolare si assicura la collaborazione per gli specifici aspetti regolamentari.

Cordiali saluti,

Ing. G. Daniele Carrabba

A handwritten signature in blue ink, appearing to be 'G. Carrabba', is written over the typed name.

Viale Castro Pretorio, 118
00185 Roma
centr. +39 06 445961
c.f. 97158180584
RAA

tel. +39 06 44596540
fax +39 06 44596331
regolazione.aerea@enac.gov.it
protocollo@pec.enac.gov.it
www.enac.gov.it

ESTIMATED BUDGET FOR THE ACTION (page 1 of 3)

Estimated eligible ¹ costs (per budget category)									EU contribution			Additional information		
A. Direct personnel costs		B. Direct costs of subcontracting	C. Direct costs of fin. support	D. Other direct costs	E. Indirect costs ²	Total costs	Reimbursement rate %	Maximum EU contribution ³	Maximum grant amount ⁴	Information for indirect costs	Information for auditors	Other information:		
A.1 Employees (or equivalent) A.2 Natural persons under direct contract A.3 Seconded persons [A.6 Personnel for providing access to research infrastructure]		A.4 SME owners without salary A.5 Beneficiaries that are natural persons without salary		D.1 Travel D.2 Equipment D.3 Other goods and services D.4 Costs of large research infrastructure						Estimated costs of in-kind contributions not used on premises	Declaration of costs under Point D.4	Estimated costs of beneficiaries/ linked third parties not receiving EU funding		
Form of costs ⁶	Actual	Unit ⁷	Unit ⁸		Actual	Actual	Actual	Flat-rate ⁹						
	(a)	Total (b)	No hours	Total (c)	(d)	(e)	(f)	(g)=0,25x ((a)+(b)+ (c)+(f) +[(h1)+(h2)]- (m))	(i)= (a)+(b)+(c)+ (d)+(e)+(f)+ (g)+(h1)+(h2)+(h3)	(j)	(k)	(l)	(m)	Yes/No
1. DTSMNS	215000.00	0.00	0	0.00	0.00	0.00	25000.00	60000.00	300000.00	35.00	105000.00	105000.00	0.00	No
- UNIPA ¹⁴	0.00	0.00	0	0.00	0.00	0.00	0.00	0.00	0.00	35.00	0.00	0.00	0.00	No
Total beneficiary 1	215000.00	0.00			0.00	0.00	25000.00	60000.00	300000.00		105000.00	105000.00	0.00	
2. ST-I	0.00	0.00	0	0.00	0.00	0.00	0.00	0.00	0.00	25.00	0.00	0.00	0.00	No
3. UNICT	0.00	0.00	0	0.00	0.00	0.00	0.00	0.00	0.00	35.00	0.00	0.00	0.00	No
4. NEXTER	324000.00	0.00	0	0.00	0.00	0.00	210000.00	133500.00	667500.00	25.00	166875.00	166875.00	0.00	No
5. VSCM	3135733.00	0.00	0	0.00	278056.00	0.00	352860.00	872148.25	4638797.25	25.00	1159699.31	1159699.31	0.00	No
6. IUNET	1.00	0.00	0	0.00	0.00	0.00	0.00	0.25	1.25	35.00	0.44	0.44	0.00	No
- UNIPD ¹⁴	290000.00	0.00	0	0.00	0.00	0.00	0.00	72500.00	362500.00	35.00	126875.00	126875.00	0.00	No
- UNIBO ¹⁴	239999.00	0.00	0	0.00	0.00	0.00	0.00	59999.75	299998.75	35.00	104999.56	104999.56	0.00	No
- UNICAL ¹⁴	150000.00	0.00	0	0.00	0.00	0.00	0.00	37500.00	187500.00	35.00	65625.00	65625.00	0.00	No
Total beneficiary 6	680000.00	0.00			0.00	0.00	0.00	170000.00	850000.00		297500.00	297500.00	0.00	
7. UNIME	0.00	0.00	0	0.00	0.00	0.00	0.00	0.00	0.00	35.00	0.00	0.00	0.00	No
8. UNIPRA	216000.00	0.00	0	0.00	0.00	0.00	21800.00	59450.00	297250.00	35.00	104037.50	104037.50	0.00	No
9. LUH	348450.00	0.00	0	0.00	20000.00	0.00	52268.00	100179.50	520897.50	35.00	182314.13	182314.13	0.00	No
10. CNR	0.00	0.00	0	0.00	0.00	0.00	0.00	0.00	0.00	35.00	0.00	0.00	0.00	No
11. ZODAERO	1267000.00	0.00	0	0.00	338000.00	0.00	468200.00	433800.00	2507000.00	25.00	626750.00	626750.00	0.00	No
12. APOJEE	948000.00	0.00	0	0.00	206000.00	0.00	513000.00	365250.00	2032250.00	30.00	609675.00	609675.00	0.00	No
13. APSI	363090.00	0.00	0	0.00	152000.00	0.00	324200.00	171822.50	1011112.50	30.00	303333.75	303333.75	0.00	No
14. SAT	0.00	0.00	0	0.00	0.00	0.00	0.00	0.00	0.00	30.00	0.00	0.00	0.00	No
15. WÜRTH	397334.00	0.00	0	0.00	0.00	0.00	41500.00	109708.50	548542.50	25.00	137135.63	137135.63	0.00	No
16. UNITOU	241200.00	0.00	0	0.00	5000.00	0.00	129000.00	92550.00	467750.00	35.00	163712.50	163712.50	0.00	No
17. IMA	225000.00	0.00	0	0.00	0.00	0.00	17000.00	60500.00	302500.00	30.00	90750.00	90750.00	0.00	No
18. ED	510000.00	0.00	0	0.00	120000.00	0.00	90000.00	150000.00	870000.00	25.00	217500.00	217500.00	0.00	No
19. SOFT	0.00	0.00	0	0.00	0.00	0.00	0.00	0.00	0.00	30.00	0.00	0.00	0.00	No
20. DAC	0.00	0.00	0	0.00	0.00	0.00	0.00	0.00	0.00	35.00	0.00	0.00	0.00	No
- Caltec/OMI ¹⁴	0.00	0.00	0	0.00	0.00	0.00	0.00	0.00	0.00	30.00	0.00	0.00	0.00	No

ESTIMATED BUDGET FOR THE ACTION (page 2 of 3)

Estimated eligible ¹ costs (per budget category)										EU contribution			Additional information		
A. Direct personnel costs		B. Direct costs of subcontracting	C. Direct costs of fin. support	D. Other direct costs	E. Indirect costs ²	Total costs	Reimbursement rate %	Maximum EU contribution ³	Maximum grant amount ⁴	Information for indirect costs	Information for auditors	Other information:			
A.1 Employees (or equivalent) A.2 Natural persons under direct contract A.3 Seconded persons [A.6 Personnel for providing access to research infrastructure]		A.4 SME owners without salary A.5 Beneficiaries that are natural persons without salary		D.1 Travel D.2 Equipment D.3 Other goods and services D.4 Costs of large research infrastructure						Estimated costs of in-kind contributions not used on premises	Declaration of costs under Point D.4	Estimated costs of beneficiaries/ linked third parties not receiving EU funding			
Form of costs ⁶	Actual	Unit ⁷	Unit ⁸		Actual	Actual	Actual	Flat-rate ⁹							
	(a)	Total (b)	No hours	Total (c)	(d)	(e)	(f)	(g)=0,25x ((a)+(b)+(c)+(f) +[(h1)+(h2)]-(m))	(i)= (a)+(b)+(c)+(d)+(e)+(f)+(g)+(h1)+(h2)+(h3)	(j)	(k)	(l)	(m)	Yes/No	
- Caltec/ REDAM ¹⁴	0.00	0.00	0	0.00	0.00	0.00	0.00	0.00	0.00	30.00	0.00	0.00	0.00	No	
Total beneficiary 20	0.00	0.00	0.00	0.00	0.00	0.00	0.00	0.00	0.00		0.00	0.00			
Total consortium	8870807.00	0.00		0.00	1119056.00	0.00	2244828.00	2778908.75	15013599.75		4164282.82	4164282.82	0.00		

ESTIMATED BUDGET FOR THE ACTION (page 3 of 3)

- (1) See Article 6 for the eligibility conditions
- (2) The indirect costs covered by the operating grant (received under any EU or Euratom funding programme; see Article 6.5.(b)) are ineligible under the GA. Therefore, a beneficiary that receives an operating grant during the action's duration cannot declare indirect costs for the year(s)/reporting period(s) covered by the operating grant (see Article 6.2.E).
- (3) This is the theoretical amount of EU contribution that the system calculates automatically (by multiplying all the budgeted costs by the reimbursement rate). This theoretical amount is capped by the 'maximum grant amount' (that the Commission/Agency decided to grant for the action) (see Article 5.1).
- (4) The 'maximum grant amount' is the maximum grant amount decided by the Commission/Agency. It normally corresponds to the requested grant, but may be lower.
- (5) Depending on its type, this specific cost category will or will not cover indirect costs. Specific unit costs that include indirect costs are: costs for energy efficiency measures in buildings, access costs for providing trans-national access to research infrastructure and costs for clinical studies.
- (6) See Article 5 for the forms of costs
- (7) Unit : hours worked on the action; costs per unit (hourly rate) : calculated according to beneficiary's usual accounting practice
- (8) See Annex 2a 'Additional information on the estimated budget' for the details (costs per hour (hourly rate)).
- (9) Flat rate : 25% of eligible direct costs, from which are excluded: direct costs of subcontracting, costs of in-kind contributions not used on premises, direct costs of financial support, and unit costs declared under budget category F if they include indirect costs
- (10) See Annex 2a 'Additional information on the estimated budget' for the details (units, costs per unit).
- (11) See Annex 2a 'Additional information on the estimated budget' for the details (units, costs per unit, estimated number of units, etc)
- (12) Only specific unit costs that do not include indirect costs
- (13) See Article 9 for beneficiaries not receiving EU funding
- (14) Only for linked third parties that receive EU funding

ANNEX 3

ACCESSION FORM FOR BENEFICIARIES

STMICROELECTRONICS SRL (ST-I), established in VIA C.OLIVETTI 2, AGRATE BRIANZA 20864, Italy, VAT number: IT00951900968, ('the beneficiary'), represented for the purpose of signing this Accession Form by the undersigned,

hereby agrees

to become beneficiary No ('2')

in Grant Agreement No 737483 ('the Agreement')

between DISTRETTO TECNOLOGICO SICILIA MICROE NANO SISTEMI SCARL **and** the Electronic Component Systems for European Leadership Joint Undertaking ('the JU'),

for the action entitled 'Wide band gap Innovative SiC for Advanced Power (WInSiC4AP)'.

and mandates

the coordinator to submit and sign in its name and on its behalf any **amendments** to the Agreement, in accordance with Article 55.

By signing this Accession Form, the beneficiary accepts the grant and agrees to implement it in accordance with the Agreement, with all the obligations and conditions it sets out.

SIGNATURE

For the beneficiary

ANNEX 3

ACCESSION FORM FOR BENEFICIARIES

UNIVERSITA DEGLI STUDI DI CATANIA (UNICT), established in PIAZZA UNIVERSITA 2, CATANIA 95131, Italy, VAT number: IT02772010878, ('the beneficiary'), represented for the purpose of signing this Accession Form by the undersigned,

hereby agrees

to become beneficiary No ('3')

in Grant Agreement No 737483 ('the Agreement')

between DISTRETTO TECNOLOGICO SICILIA MICROE NANO SISTEMI SCARL **and** the Electronic Component Systems for European Leadership Joint Undertaking ('the JU'),

for the action entitled 'Wide band gap Innovative SiC for Advanced Power (WInSiC4AP)'.

and mandates

the coordinator to submit and sign in its name and on its behalf any **amendments** to the Agreement, in accordance with Article 55.

By signing this Accession Form, the beneficiary accepts the grant and agrees to implement it in accordance with the Agreement, with all the obligations and conditions it sets out.

SIGNATURE

For the beneficiary

ANNEX 3

ACCESSION FORM FOR BENEFICIARIES

NEXTER ELECTRONICS (NEXTER), established in 13 ROUTE DE LA MINIERE, VERSAILLES 78034, France, VAT number: FR36439568700, ('the beneficiary'), represented for the purpose of signing this Accession Form by the undersigned,

hereby agrees

to become beneficiary No ('4')

in Grant Agreement No 737483 ('the Agreement')

between DISTRETTO TECNOLOGICO SICILIA MICROE NANO SISTEMI SCARL **and** the Electronic Component Systems for European Leadership Joint Undertaking ('the JU'),

for the action entitled 'Wide band gap Innovative SiC for Advanced Power (WInSiC4AP)'.

and mandates

the coordinator to submit and sign in its name and on its behalf any **amendments** to the Agreement, in accordance with Article 55.

By signing this Accession Form, the beneficiary accepts the grant and agrees to implement it in accordance with the Agreement, with all the obligations and conditions it sets out.

SIGNATURE

For the beneficiary

ANNEX 3

ACCESSION FORM FOR BENEFICIARIES

VALEO SYSTEMES DE CONTROLE MOTEUR SAS (VSCM), established in Avenue des Beguines 14, Cergy 95800, France, VAT number: FR89479162695, ('the beneficiary'), represented for the purpose of signing this Accession Form by the undersigned,

hereby agrees

to become beneficiary No ('5')

in Grant Agreement No 737483 ('the Agreement')

between DISTRETTO TECNOLOGICO SICILIA MICROE NANO SISTEMI SCARL and the Electronic Component Systems for European Leadership Joint Undertaking ('the JU'),

for the action entitled 'Wide band gap Innovative SiC for Advanced Power (WInSiC4AP)'.

and mandates

the coordinator to submit and sign in its name and on its behalf any **amendments** to the Agreement, in accordance with Article 55.

By signing this Accession Form, the beneficiary accepts the grant and agrees to implement it in accordance with the Agreement, with all the obligations and conditions it sets out.

SIGNATURE

For the beneficiary

ANNEX 3

ACCESSION FORM FOR BENEFICIARIES

CONSORZIO NAZIONALE INTERUNIVERSITARIO PER LA NANOELETTRONICA (IUNET), established in VIA TOFFANO 2, BOLOGNA 40125, Italy, VAT number: IT02598581201, ('the beneficiary'), represented for the purpose of signing this Accession Form by the undersigned,

hereby agrees

to become beneficiary No ('6')

in Grant Agreement No 737483 ('the Agreement')

between DISTRETTO TECNOLOGICO SICILIA MICROE NANO SISTEMI SCARL **and** the Electronic Component Systems for European Leadership Joint Undertaking ('the JU'),

for the action entitled 'Wide band gap Innovative SiC for Advanced Power (WInSiC4AP)'.

and mandates

the coordinator to submit and sign in its name and on its behalf any **amendments** to the Agreement, in accordance with Article 55.

By signing this Accession Form, the beneficiary accepts the grant and agrees to implement it in accordance with the Agreement, with all the obligations and conditions it sets out.

SIGNATURE

For the beneficiary

ANNEX 3

ACCESSION FORM FOR BENEFICIARIES

UNIVERSITA DEGLI STUDI DI MESSINA (UNIME), established in PIAZZA PUGLIATTI 1, MESSINA 98122, Italy, VAT number: IT00724160833, ('the beneficiary'), represented for the purpose of signing this Accession Form by the undersigned,

hereby agrees

to become beneficiary No ('7')

in Grant Agreement No 737483 ('the Agreement')

between DISTRETTO TECNOLOGICO SICILIA MICROE NANO SISTEMI SCARL **and** the Electronic Component Systems for European Leadership Joint Undertaking ('the JU'),

for the action entitled 'Wide band gap Innovative SiC for Advanced Power (WInSiC4AP)'.

and mandates

the coordinator to submit and sign in its name and on its behalf any **amendments** to the Agreement, in accordance with Article 55.

By signing this Accession Form, the beneficiary accepts the grant and agrees to implement it in accordance with the Agreement, with all the obligations and conditions it sets out.

SIGNATURE

For the beneficiary

ANNEX 3

ACCESSION FORM FOR BENEFICIARIES

CESKE VYSOKE UCENI TECHNICKE V PRAZE (UNIPRA), established in ZIKOVA 4, PRAHA 16636, Czech Republic, VAT number: CZ68407700, ('the beneficiary'), represented for the purpose of signing this Accession Form by the undersigned,

hereby agrees

to become beneficiary No ('8')

in Grant Agreement No 737483 ('the Agreement')

between DISTRETTO TECNOLOGICO SICILIA MICROE NANO SISTEMI SCARL **and** the Electronic Component Systems for European Leadership Joint Undertaking ('the JU'),

for the action entitled 'Wide band gap Innovative SiC for Advanced Power (WInSiC4AP)'.

and mandates

the coordinator to submit and sign in its name and on its behalf any **amendments** to the Agreement, in accordance with Article 55.

By signing this Accession Form, the beneficiary accepts the grant and agrees to implement it in accordance with the Agreement, with all the obligations and conditions it sets out.

SIGNATURE

For the beneficiary

ANNEX 3

ACCESSION FORM FOR BENEFICIARIES

GOTTFRIED WILHELM LEIBNIZ UNIVERSITAET HANNOVER (LUH), established in Welfengarten 1, HANNOVER 30167, Germany, VAT number: DE811245527, ('the beneficiary'), represented for the purpose of signing this Accession Form by the undersigned,

hereby agrees

to become beneficiary No ('9')

in Grant Agreement No 737483 ('the Agreement')

between DISTRETTO TECNOLOGICO SICILIA MICROE NANO SISTEMI SCARL **and** the Electronic Component Systems for European Leadership Joint Undertaking ('the JU'),

for the action entitled 'Wide band gap Innovative SiC for Advanced Power (WInSiC4AP)'.

and mandates

the coordinator to submit and sign in its name and on its behalf any **amendments** to the Agreement, in accordance with Article 55.

By signing this Accession Form, the beneficiary accepts the grant and agrees to implement it in accordance with the Agreement, with all the obligations and conditions it sets out.

SIGNATURE

For the beneficiary

ANNEX 3

ACCESSION FORM FOR BENEFICIARIES

CONSIGLIO NAZIONALE DELLE RICERCHE (CNR), established in PIAZZALE ALDO MORO 7, ROMA 00185, Italy, VAT number: IT02118311006, ('the beneficiary'), represented for the purpose of signing this Accession Form by the undersigned,

hereby agrees

to become beneficiary No ('10')

in Grant Agreement No 737483 ('the Agreement')

between DISTRETTO TECNOLOGICO SICILIA MICROE NANO SISTEMI SCARL **and** the Electronic Component Systems for European Leadership Joint Undertaking ('the JU'),

for the action entitled 'Wide band gap Innovative SiC for Advanced Power (WInSiC4AP)'.

and mandates

the coordinator to submit and sign in its name and on its behalf any **amendments** to the Agreement, in accordance with Article 55.

By signing this Accession Form, the beneficiary accepts the grant and agrees to implement it in accordance with the Agreement, with all the obligations and conditions it sets out.

SIGNATURE

For the beneficiary

ANNEX 3

ACCESSION FORM FOR BENEFICIARIES

ZODIAC AERO ELECTRIC SAS (ZODAERO), established in RUE DES LONGS QUARTIERS 7, MONTREUIL 93100, France, VAT number: FR95775694995, ('the beneficiary'), represented for the purpose of signing this Accession Form by the undersigned,

hereby agrees

to become beneficiary No ('11')

in Grant Agreement No 737483 ('the Agreement')

between DISTRETTO TECNOLOGICO SICILIA MICROE NANO SISTEMI SCARL **and** the Electronic Component Systems for European Leadership Joint Undertaking ('the JU'),

for the action entitled 'Wide band gap Innovative SiC for Advanced Power (WInSiC4AP)'.

and mandates

the coordinator to submit and sign in its name and on its behalf any **amendments** to the Agreement, in accordance with Article 55.

By signing this Accession Form, the beneficiary accepts the grant and agrees to implement it in accordance with the Agreement, with all the obligations and conditions it sets out.

SIGNATURE

For the beneficiary

ANNEX 3

ACCESSION FORM FOR BENEFICIARIES

APOJEE (APOJEE), established in RUE GEORGES BESSE 29, CLERMONT FERRAND 63100, France, VAT number: FR27424963213, ('the beneficiary'), represented for the purpose of signing this Accession Form by the undersigned,

hereby agrees

to become beneficiary No ('12')

in Grant Agreement No 737483 ('the Agreement')

between DISTRETTO TECNOLOGICO SICILIA MICROE NANO SISTEMI SCARL **and** the Electronic Component Systems for European Leadership Joint Undertaking ('the JU'),

for the action entitled 'Wide band gap Innovative SiC for Advanced Power (WInSiC4AP)'.

and mandates

the coordinator to submit and sign in its name and on its behalf any **amendments** to the Agreement, in accordance with Article 55.

By signing this Accession Form, the beneficiary accepts the grant and agrees to implement it in accordance with the Agreement, with all the obligations and conditions it sets out.

SIGNATURE

For the beneficiary

ANNEX 3

ACCESSION FORM FOR BENEFICIARIES

APSI3D (APSI), established in 67 BOULEVARD PIERRE RENAUDET, TARBES 65000, France, VAT number: FR05792492746, ('the beneficiary'), represented for the purpose of signing this Accession Form by the undersigned,

hereby agrees

to become beneficiary No ('13')

in Grant Agreement No 737483 ('the Agreement')

between DISTRETTO TECNOLOGICO SICILIA MICROE NANO SISTEMI SCARL **and** the Electronic Component Systems for European Leadership Joint Undertaking ('the JU'),

for the action entitled 'Wide band gap Innovative SiC for Advanced Power (WInSiC4AP)'.

and mandates

the coordinator to submit and sign in its name and on its behalf any **amendments** to the Agreement, in accordance with Article 55.

By signing this Accession Form, the beneficiary accepts the grant and agrees to implement it in accordance with the Agreement, with all the obligations and conditions it sets out.

SIGNATURE

For the beneficiary

ANNEX 3

ACCESSION FORM FOR BENEFICIARIES

S.A.T.SICILIANA ARTICOLI TECNICI SRL (SAT), established in VIA ALFREDO AGOSTA 31-33-35, CATANIA 95121, Italy, VAT number: IT02390350870, ('the beneficiary'), represented for the purpose of signing this Accession Form by the undersigned,

hereby agrees

to become beneficiary No ('14')

in Grant Agreement No 737483 ('the Agreement')

between DISTRETTO TECNOLOGICO SICILIA MICROE NANO SISTEMI SCARL **and** the Electronic Component Systems for European Leadership Joint Undertaking ('the JU'),

for the action entitled 'Wide band gap Innovative SiC for Advanced Power (WInSiC4AP)'.

and mandates

the coordinator to submit and sign in its name and on its behalf any **amendments** to the Agreement, in accordance with Article 55.

By signing this Accession Form, the beneficiary accepts the grant and agrees to implement it in accordance with the Agreement, with all the obligations and conditions it sets out.

SIGNATURE

For the beneficiary

ANNEX 3

ACCESSION FORM FOR BENEFICIARIES

WURTH ELEKTRONIK EISOS GMBH & CO KG (WÜRTH), established in MAX EYTH STRASSE 1, WALDENBURG 74638, Germany, VAT number: DE220618976, ('the beneficiary'), represented for the purpose of signing this Accession Form by the undersigned,

hereby agrees

to become beneficiary No ('15')

in Grant Agreement No 737483 ('the Agreement')

between DISTRETTO TECNOLOGICO SICILIA MICROE NANO SISTEMI SCARL **and** the Electronic Component Systems for European Leadership Joint Undertaking ('the JU'),

for the action entitled 'Wide band gap Innovative SiC for Advanced Power (WInSiC4AP)'.

and mandates

the coordinator to submit and sign in its name and on its behalf any **amendments** to the Agreement, in accordance with Article 55.

By signing this Accession Form, the beneficiary accepts the grant and agrees to implement it in accordance with the Agreement, with all the obligations and conditions it sets out.

SIGNATURE

For the beneficiary

ANNEX 3

ACCESSION FORM FOR BENEFICIARIES

UNIVERSITE FRANCOIS RABELAIS DE TOURS (UNITOU), established in RUE DU PLAT D ETAIN 60, TOURS 37020, France, VAT number: FR34193708005, ('the beneficiary'), represented for the purpose of signing this Accession Form by the undersigned,

hereby agrees

to become beneficiary No ('16')

in Grant Agreement No 737483 ('the Agreement')

between DISTRETTO TECNOLOGICO SICILIA MICROE NANO SISTEMI SCARL **and** the Electronic Component Systems for European Leadership Joint Undertaking ('the JU'),

for the action entitled 'Wide band gap Innovative SiC for Advanced Power (WInSiC4AP)'.

and mandates

the coordinator to submit and sign in its name and on its behalf any **amendments** to the Agreement, in accordance with Article 55.

By signing this Accession Form, the beneficiary accepts the grant and agrees to implement it in accordance with the Agreement, with all the obligations and conditions it sets out.

SIGNATURE

For the beneficiary

ANNEX 3

ACCESSION FORM FOR BENEFICIARIES

INSTITUT MIKROELEKTRONICKYCH APLIKACI S.R.O. (IMA), established in NA VALENTINCE 1003/1, PRAHA 5 - SMICHOV 150 00, Czech Republic, VAT number: CZ45277397, ('the beneficiary'), represented for the purpose of signing this Accession Form by the undersigned,

hereby agrees

to become beneficiary No ('17')

in Grant Agreement No 737483 ('the Agreement')

between DISTRETTO TECNOLOGICO SICILIA MICROE NANO SISTEMI SCARL **and** the Electronic Component Systems for European Leadership Joint Undertaking ('the JU'),

for the action entitled 'Wide band gap Innovative SiC for Advanced Power (WInSiC4AP)'.

and mandates

the coordinator to submit and sign in its name and on its behalf any **amendments** to the Agreement, in accordance with Article 55.

By signing this Accession Form, the beneficiary accepts the grant and agrees to implement it in accordance with the Agreement, with all the obligations and conditions it sets out.

SIGNATURE

For the beneficiary

ANNEX 3

ACCESSION FORM FOR BENEFICIARIES

E-DISTRIBUZIONE SPA (ED), established in VIA OMBRONE 2, ROMA 00198, Italy, VAT number: IT05779711000, ('the beneficiary'), represented for the purpose of signing this Accession Form by the undersigned,

hereby agrees

to become beneficiary No ('18')

in Grant Agreement No 737483 ('the Agreement')

between DISTRETTO TECNOLOGICO SICILIA MICROE NANO SISTEMI SCARL **and** the Electronic Component Systems for European Leadership Joint Undertaking ('the JU'),

for the action entitled 'Wide band gap Innovative SiC for Advanced Power (WInSiC4AP)'.

and mandates

the coordinator to submit and sign in its name and on its behalf any **amendments** to the Agreement, in accordance with Article 55.

By signing this Accession Form, the beneficiary accepts the grant and agrees to implement it in accordance with the Agreement, with all the obligations and conditions it sets out.

SIGNATURE

For the beneficiary

ANNEX 3

ACCESSION FORM FOR BENEFICIARIES

SOFTECO SISMAT SRL (SOFT), established in VIA DE MARINI 1, GENOVA 16149, Italy, VAT number: IT02581250103, ('the beneficiary'), represented for the purpose of signing this Accession Form by the undersigned,

hereby agrees

to become beneficiary No ('19')

in Grant Agreement No 737483 ('the Agreement')

between DISTRETTO TECNOLOGICO SICILIA MICROE NANO SISTEMI SCARL **and** the Electronic Component Systems for European Leadership Joint Undertaking ('the JU'),

for the action entitled 'Wide band gap Innovative SiC for Advanced Power (WInSiC4AP)'.

and mandates

the coordinator to submit and sign in its name and on its behalf any **amendments** to the Agreement, in accordance with Article 55.

By signing this Accession Form, the beneficiary accepts the grant and agrees to implement it in accordance with the Agreement, with all the obligations and conditions it sets out.

SIGNATURE

For the beneficiary

ANNEX 3

ACCESSION FORM FOR BENEFICIARIES

DISTRETTO TECNOLOGICO AEROSPAZIALE DELLA CAMPANIA SCARL (DAC), established in VIA MAIORISE, CAPUA 81043, Italy, VAT number: IT03807450618, ('the beneficiary'), represented for the purpose of signing this Accession Form by the undersigned,

hereby agrees

to become beneficiary No ('20')

in Grant Agreement No 737483 ('the Agreement')

between DISTRETTO TECNOLOGICO SICILIA MICROE NANO SISTEMI SCARL **and** the Electronic Component Systems for European Leadership Joint Undertaking ('the JU'),

for the action entitled 'Wide band gap Innovative SiC for Advanced Power (WInSiC4AP)'.

and mandates

the coordinator to submit and sign in its name and on its behalf any **amendments** to the Agreement, in accordance with Article 55.

By signing this Accession Form, the beneficiary accepts the grant and agrees to implement it in accordance with the Agreement, with all the obligations and conditions it sets out.

SIGNATURE

For the beneficiary

print format A4 landscape

MODEL ANNEX 4 FOR H2020 GENERAL MGA — MULTI

FINANCIAL STATEMENT FOR [BENEFICIARY [name]/ LINKED THIRD PARTY [name]] FOR REPORTING PERIOD [reporting period]

Eligible ¹ costs (per budget category)												Receipts	EU contribution			Additional information			
A. Direct personnel costs				B. Direct costs of subcontracting	[C. Direct costs of fin. support]	D. Other direct costs		E. Indirect costs ²	[F. Costs of ...]			Total costs	Receipts	Reimbursement rate %	Maximum EU contribution ³	Requested EU contribution	Information for indirect costs :		
A.1 Employees (or equivalent)		A.4 SME owners without salary				D.1 Travel	[D.4 Costs of large research infrastructure]		[F.1 Costs of ...]				Receipts of the action, to be reported in the last reporting period, according to Article 5.3.3				Costs of in-kind contributions not used on premises		
A.2 Natural persons under direct contract		A.5 Beneficiaries that are natural persons without salary				D.2 Equipment													
A.3 Seconded persons		[A.6 Personnel for providing access to research infrastructure]				D.3 Other goods and services													
Form of costs ⁴		Actual	Unit	Unit		Actual	Actual	Actual	Actual	Flat-rate ⁵	Unit	Unit							
										25%									
		a	Total b	No hours	Total c	d	[e]	f	[g]	h=0,25 x (a+b+c+f+[g] + [i1] ⁶ + [i2] ⁶ - o)	No units	Total [i1]	Total [i2]	j = a+b+c+d+[e] + f + [g] + h + [i1] + [i2]	k	l	m	n	o
[short name beneficiary/linked third party]																			

The beneficiary/linked third party hereby confirms that:
 The information provided is complete, reliable and true.
 The costs declared are eligible (see Article 6).
 The costs can be substantiated by adequate records and supporting documentation that will be produced upon request or in the context of checks, reviews, audits and investigations (see Articles 17, 18 and 22).
 For the last reporting period: that all the receipts have been declared (see Article 5.3.3).

Please declare all eligible costs, even if they exceed the amounts indicated in the estimated budget (see Annex 2). Only amounts that were declared in your individual financial statements can be taken into account lateron, in order to replace other costs that are found to be ineligible.

¹ See Article 6 for the eligibility conditions

² The indirect costs claimed must be free of any amounts covered by an operating grant (received under any EU or Euratom funding programme; see Article 6.2.E). If you have received an operating grant during this reporting period, you cannot claim any indirect costs.

³ This is the theoretical amount of EU contribution that the system calculates automatically (by multiplying the reimbursement rate by the total costs declared). The amount you request (in the column 'requested EU contribution') may have to be less (e.g. if you and the other beneficiaries are above budget, if the 90% limit (see Article 21) is reached, etc).

⁴ See Article 5 for the form of costs

⁵ Flat rate : 25% of eligible direct costs, from which are excluded: direct costs of subcontracting, costs of in-kind contributions not used on premises, direct costs of financial support, and unit costs declared under budget category F if they include indirect costs (see Article 6.2.E)

⁶ Only specific unit costs that do not include indirect costs

ANNEX 5

MODEL FOR THE CERTIFICATE ON THE FINANCIAL STATEMENTS

- For options [*in italics in square brackets*]: choose the applicable option. Options not chosen should be deleted.
- For fields in [grey in square brackets]: enter the appropriate data

TABLE OF CONTENTS

TERMS OF REFERENCE FOR AN INDEPENDENT REPORT OF FACTUAL FINDINGS ON COSTS DECLARED UNDER A GRANT AGREEMENT FINANCED UNDER THE HORIZON 2020 RESEARCH FRAMEWORK PROGRAMME.....	2
INDEPENDENT REPORT OF FACTUAL FINDINGS ON COSTS DECLARED UNDER A GRANT AGREEMENT FINANCED UNDER THE HORIZON 2020 RESEARCH FRAMEWORK PROGRAMME	5

Terms of Reference for an Independent Report of Factual Findings on costs declared under a Grant Agreement financed by the [BBI][Clean Sky 2][ECSEL][FCH][IMI2] Joint Undertaking under the Horizon 2020 Research and Innovation Framework Programme

This document sets out the ‘**Terms of Reference (ToR)**’ under which

[OPTION 1: [insert name of the beneficiary] (*‘the Beneficiary’*)] [OPTION 2: [insert name of the linked third party] (*‘the Linked Third Party’*), third party linked to the Beneficiary [insert name of the beneficiary] (*‘the Beneficiary’*)]

agrees to engage

[insert legal name of the auditor] (*‘the Auditor’*)

to produce an independent report of factual findings (*‘the Report’*) concerning the Financial Statement(s)¹ drawn up by the [Beneficiary] [Linked Third Party] for the Horizon 2020 grant agreement [insert number of the grant agreement, title of the action, acronym and duration from/to] (*‘the Agreement’*), and

to issue a Certificate on the Financial Statements’ (*‘CFS’*) referred to in Article 20.4 of the Agreement based on the compulsory reporting template stipulated by the Commission.

The Agreement has been concluded under the Horizon 2020 Research and Innovation Framework Programme (H2020) between the Beneficiary and [the [Bio Based Industries][Clean Sky 2][ECSEL][Fuel Cells and Hydrogen 2][Innovative Medicines Initiative 2] Joint Undertaking (*‘the JU’*)], which receives funding under the Horizon 2020 Research and Innovation Framework Programme (H2020)].

The JU is mentioned as a signatory of the Agreement with the Beneficiary only. The JU is not a party to this engagement.

1.1 Subject of the engagement

The coordinator must submit to the JU the final report within 60 days following the end of the last reporting period which should include, amongst other documents, a CFS for each beneficiary and for each linked third party that requests a total contribution of EUR 325 000 or more, as reimbursement of actual costs and unit costs calculated on the basis of its usual cost accounting practices (see Article 20.4 of the Agreement). The CFS must cover all reporting periods of the beneficiary or linked third party indicated above.

The Beneficiary must submit to the coordinator the CFS for itself and for its linked third party(ies), if the CFS must be included in the final report according to Article 20.4 of the Agreement..

The CFS is composed of two separate documents:

- The Terms of Reference (*‘the ToR’*) to be signed by the [Beneficiary] [Linked Third Party] and the Auditor;
- The Auditor’s Independent Report of Factual Findings (*‘the Report’*) to be issued on the Auditor’s letterhead, dated, stamped and signed by the Auditor (or the competent public officer) which includes the agreed-upon procedures (*‘the Procedures’*) to be performed by the Auditor, and the standard factual findings (*‘the Findings’*) to be confirmed by the Auditor.

¹ By which costs under the Agreement are declared (see template ‘Model Financial Statements’ in Annex 4 to the Grant Agreement).

If the CFS must be included in the final report according to Article 20.4 of the Agreement, the request for payment of the balance relating to the Agreement cannot be made without the CFS. However, the payment for reimbursement of costs covered by the CFS does not preclude the JU, the Commission, the European Anti-Fraud Office and the European Court of Auditors from carrying out checks, reviews, audits and investigations in accordance with Article 22 of the Agreement.

1.2 Responsibilities

The *[Beneficiary]* *[Linked Third Party]*:

- must draw up the Financial Statement(s) for the action financed by the Agreement in compliance with the obligations under the Agreement. The Financial Statement(s) must be drawn up according to the *[Beneficiary's]* *[Linked Third Party's]* accounting and book-keeping system and the underlying accounts and records;
- must send the Financial Statement(s) to the Auditor;
- is responsible and liable for the accuracy of the Financial Statement(s);
- is responsible for the completeness and accuracy of the information provided to enable the Auditor to carry out the Procedures. It must provide the Auditor with a written representation letter supporting these statements. The written representation letter must state the period covered by the statements and must be dated;
- accepts that the Auditor cannot carry out the Procedures unless it is given full access to the *[Beneficiary's]* *[Linked Third Party's]* staff and accounting as well as any other relevant records and documentation.

The Auditor:

- *[Option 1 by default:* is qualified to carry out statutory audits of accounting documents in accordance with Directive 2006/43/EC of the European Parliament and of the Council of 17 May 2006 on statutory audits of annual accounts and consolidated accounts, amending Council Directives 78/660/EEC and 83/349/EEC and repealing Council Directive 84/253/EEC or similar national regulations].
- *[Option 2 if the Beneficiary or Linked Third Party has an independent Public Officer:* is a competent and independent Public Officer for which the relevant national authorities have established the legal capacity to audit the Beneficiary].
- *[Option 3 if the Beneficiary or Linked Third Party is an international organisation:* is an [internal] [external] auditor in accordance with the internal financial regulations and procedures of the international organisation].

The Auditor:

- must be independent from the Beneficiary *[and the Linked Third Party]*, in particular, it must not have been involved in preparing the *[Beneficiary's]* *[Linked Third Party's]* Financial Statement(s);
- must plan work so that the Procedures may be carried out and the Findings may be assessed;
- must adhere to the Procedures laid down and the compulsory report format;
- must carry out the engagement in accordance with this ToR;
- must document matters which are important to support the Report;
- must base its Report on the evidence gathered;
- must submit the Report to the *[Beneficiary]* *[Linked Third Party]*.

The Commission sets out the Procedures to be carried out by the Auditor. The Auditor is not responsible for their suitability or pertinence. As this engagement is not an assurance engagement, the Auditor does not provide an audit opinion or a statement of assurance.

1.3 Applicable Standards

The Auditor must comply with these Terms of Reference and with²:

- the International Standard on Related Services ('ISRS') 4400 *Engagements to perform Agreed-upon Procedures regarding Financial Information* as issued by the International Auditing and Assurance Standards Board (IAASB);
- the *Code of Ethics for Professional Accountants* issued by the International Ethics Standards Board for Accountants (IESBA). Although ISRS 4400 states that independence is not a requirement for engagements to carry out agreed-upon procedures, the JU requires that the Auditor also complies with the Code's independence requirements.

The Auditor's Report must state that there is no conflict of interests in establishing this Report between the Auditor and the Beneficiary *[and the Linked Third Party]*, and must specify - if the service is invoiced - the total fee paid to the Auditor for providing the Report.

1.4 Reporting

The Report must be written in the language of the Agreement (see Article 20.7).

Under Article 22 of the Agreement, the JU, the Commission, the European Anti-Fraud Office and the Court of Auditors have the right to audit any work that is carried out under the action and for which costs are declared from the European Union budget. This includes work related to this engagement. The Auditor must provide access to all working papers (e.g. recalculation of hourly rates, verification of the time declared for the action) related to this assignment if the JU, the Commission, the European Anti-Fraud Office or the European Court of Auditors requests them.

1.5 Timing

The Report must be provided by [dd Month yyyy].

1.6 Other terms

[The [Beneficiary] [Linked Third Party] and the Auditor can use this section to agree other specific terms, such as the Auditor's fees, liability, applicable law, etc. Those specific terms must not contradict the terms specified above.]

[legal name of the Auditor]	[legal name of the [Beneficiary][Linked Third Party]]
[name & function of authorised representative]	[name & function of authorised representative]
[dd Month yyyy]	[dd Month yyyy]
Signature of the Auditor	Signature of the [Beneficiary][Linked Third Party]

² Supreme Audit Institutions applying INTOSAI-standards may carry out the Procedures according to the corresponding International Standards of Supreme Audit Institutions and code of ethics issued by INTOSAI instead of the International Standard on Related Services ('ISRS') 4400 and the Code of Ethics for Professional Accountants issued by the IAASB and the IESBA.

Independent Report of Factual Findings on costs declared under a Grant Agreement financed by the [BBI][Clean Sky 2][ECSEL][FCH][IMI2] JU under the Horizon 2020 Research and Innovation Framework Programme

(To be printed on the Auditor's letterhead)

To

[name of contact person(s)], [Position]
[[Beneficiary's] [Linked Third Party's] name]
[Address]
[dd Month yyyy]

Dear [Name of contact person(s)],

As agreed under the terms of reference dated [dd Month yyyy]

with [OPTION 1: [insert name of the beneficiary] ('the Beneficiary')] [OPTION 2: [insert name of the linked third party] ('the Linked Third Party'), third party linked to the Beneficiary [insert name of the beneficiary] ('the Beneficiary')],

we

[name of the auditor] ('the Auditor'),
established at
[full address/city/state/province/country],
represented by
[name and function of an authorised representative],

have carried out the procedures agreed with you regarding the costs declared in the Financial Statement(s)³ of the [Beneficiary] [Linked Third Party] concerning the grant agreement [insert grant agreement reference: number, title of the action and acronym] ('the Agreement'),

with a total cost declared of
[total amount] EUR,

and a total of actual costs and 'direct personnel costs declared as unit costs calculated in accordance with the [Beneficiary's] [Linked Third Party's] usual cost accounting practices' declared of

[sum of total actual costs and total direct personnel costs declared as unit costs calculated in accordance with the [Beneficiary's] [Linked Third Party's] usual cost accounting practices] EUR

and **hereby provide our Independent Report of Factual Findings ('the Report')** using the compulsory report format agreed with you.

The Report

Our engagement was carried out in accordance with the terms of reference ('the ToR') appended to this Report. The Report includes the agreed-upon procedures ('the Procedures') carried out and the standard factual findings ('the Findings') examined.

³ By which the Beneficiary declares costs under the Agreement (see template 'Model Financial Statement' in Annex 4 to the Agreement).

[BBI][Clean Sky 2][ECSEL][FCH][IMI2] JU Multi-Beneficiary Model Grant Agreement [Clean Sky 2: [for Partners]][for Members]] - April 2015

The Procedures were carried out solely to assist the JU in evaluating whether the [*Beneficiary's*] [*Linked Third Party's*] costs in the accompanying Financial Statement(s) were declared in accordance with the Agreement. The JU draws its own conclusions from the Report and any additional information it may require.

The scope of the Procedures was defined by the Commission. Therefore, the Auditor is not responsible for their suitability or pertinence. Since the Procedures carried out constitute neither an audit nor a review made in accordance with International Standards on Auditing or International Standards on Review Engagements, the Auditor does not give a statement of assurance on the Financial Statements.

Had the Auditor carried out additional procedures or an audit of the [*Beneficiary's*] [*Linked Third Party's*] Financial Statements in accordance with International Standards on Auditing or International Standards on Review Engagements, other matters might have come to its attention and would have been included in the Report.

Not applicable Findings

We examined the Financial Statement(s) stated above and considered the following Findings not applicable:

Explanation (to be removed from the Report):

If a Finding was not applicable, it must be marked as 'N.A.' ('Not applicable') in the corresponding row on the right-hand column of the table and means that the Finding did not have to be corroborated by the Auditor and the related Procedure(s) did not have to be carried out.

The reasons of the non-application of a certain Finding must be obvious i.e.

- i) if no cost was declared under a certain category then the related Finding(s) and Procedure(s) are not applicable;*
- ii) if the condition set to apply certain Procedure(s) are not met the related Finding(s) and those Procedure(s) are not applicable. For instance, for 'beneficiaries with accounts established in a currency other than euro' the Procedure and Finding related to 'beneficiaries with accounts established in euro' are not applicable. Similarly, if no additional remuneration is paid, the related Finding(s) and Procedure(s) for additional remuneration are not applicable.*

List here all Findings considered not applicable for the present engagement and explain the reasons of the non-applicability.

....

Exceptions

Apart from the exceptions listed below, the [*Beneficiary*] [*Linked Third Party*] provided the Auditor all the documentation and accounting information needed by the Auditor to carry out the requested Procedures and evaluate the Findings.

Explanation (to be removed from the Report):

- If the Auditor was not able to successfully complete a procedure requested, it must be marked as 'E' ('Exception') in the corresponding row on the right-hand column of the table. The reason such as the inability to reconcile key information or the unavailability of data that prevents the Auditor from carrying out the Procedure must be indicated below.*
- If the Auditor cannot corroborate a standard finding after having carried out the corresponding procedure, it must also be marked as 'E' ('Exception') and, where possible, the reasons why the Finding was not fulfilled and its possible impact must be explained here below.*

List here any exceptions and add any information on the cause and possible consequences of each exception, if known. If the exception is quantifiable, include the corresponding amount.

....

Example (to be removed from the Report):

1. *The Beneficiary was unable to substantiate the Finding number 1 on ... because*
2. *Finding number 30 was not fulfilled because the methodology used by the Beneficiary to calculate unit costs was different from the one approved by the Commission. The differences were as follows: ...*
3. *After carrying out the agreed procedures to confirm the Finding number 31, the Auditor found a difference of _____ EUR. The difference can be explained by ...*

Further Remarks

In addition to reporting on the results of the specific procedures carried out, the Auditor would like to make the following general remarks:

Example (to be removed from the Report):

1. *Regarding Finding number 8 the conditions for additional remuneration were considered as fulfilled because ...*
2. *In order to be able to confirm the Finding number 15 we carried out the following additional procedures:*

Use of this Report

This Report may be used only for the purpose described in the above objective. It was prepared solely for the confidential use of the [Beneficiary] [Linked Third Party], the JU and the Commission, and only to be submitted to the JU in connection with the requirements set out in Article 20.4 of the Agreement. The Report may not be used by the [Beneficiary] [Linked Third Party] or by the JU or the Commission for any other purpose, nor may it be distributed to any other parties. The JU or the Commission may only disclose the Report to authorised parties, in particular to the European Anti-Fraud Office (OLAF) and the European Court of Auditors.

This Report relates only to the Financial Statement(s) submitted to the JU by the [Beneficiary] [Linked Third Party] for the Agreement. Therefore, it does not extend to any other of the [Beneficiary's] [Linked Third Party's] Financial Statement(s).

There was no conflict of interest⁴ between the Auditor and the Beneficiary [and Linked Third Party] in establishing this Report. The total fee paid to the Auditor for providing the Report was EUR [] (including EUR [] of deductible VAT).

We look forward to discussing our Report with you and would be pleased to provide any further information or assistance.

[legal name of the Auditor]

[name and function of an authorised representative]

[dd Month yyyy]

Signature of the Auditor

⁴ A conflict of interest arises when the Auditor's objectivity to establish the certificate is compromised in fact or in appearance when the Auditor for instance:

- was involved in the preparation of the Financial Statements;
- stands to benefit directly should the certificate be accepted;
- has a close relationship with any person representing the beneficiary;
- is a director, trustee or partner of the beneficiary; or
- is in any other situation that compromises his or her independence or ability to establish the certificate impartially.

Agreed-upon procedures to be performed and standard factual findings to be confirmed by the Auditor

The Commission reserves the right to i) provide the auditor with additional guidance regarding the procedures to be followed or the facts to be ascertained and the way in which to present them (this may include sample coverage and findings) or to ii) change the procedures, by notifying the Beneficiary in writing. The procedures carried out by the auditor to confirm the standard factual finding are listed in the table below.

If this certificate relates to a Linked Third Party, any reference here below to ‘the Beneficiary’ is to be considered as a reference to ‘the Linked Third Party’.

The ‘result’ column has three different options: ‘C’, ‘E’ and ‘N.A.’:

- ‘C’ stands for ‘confirmed’ and means that the auditor can confirm the ‘standard factual finding’ and, therefore, there is no exception to be reported.
- ‘E’ stands for ‘exception’ and means that the Auditor carried out the procedures but cannot confirm the ‘standard factual finding’, or that the Auditor was not able to carry out a specific procedure (e.g. because it was impossible to reconcile key information or data were unavailable),
- ‘N.A.’ stands for ‘not applicable’ and means that the Finding did not have to be examined by the Auditor and the related Procedure(s) did not have to be carried out. The reasons of the non-application of a certain Finding must be obvious i.e. i) if no cost was declared under a certain category then the related Finding(s) and Procedure(s) are not applicable; ii) if the condition set to apply certain Procedure(s) are not met then the related Finding(s) and Procedure(s) are not applicable. For instance, for ‘beneficiaries with accounts established in a currency other than the euro’ the Procedure related to ‘beneficiaries with accounts established in euro’ is not applicable. Similarly, if no additional remuneration is paid, the related Finding(s) and Procedure(s) for additional remuneration are not applicable.

Ref	Procedures	Standard factual finding	Result (C / E / N.A.)
A	ACTUAL PERSONNEL COSTS AND UNIT COSTS CALCULATED BY THE BENEFICIARY IN ACCORDANCE WITH ITS USUAL COST ACCOUNTING PRACTICE		
	<p>The Auditor draws a sample of persons whose costs were declared in the Financial Statement(s) to carry out the procedures indicated in the consecutive points of this section A.</p> <p><i>(The sample should be selected randomly so that it is representative. Full coverage is required if there are fewer than 10 people (including employees, natural persons working under a direct contract and personnel seconded by a third party), otherwise the sample should have a minimum of 10 people, or 10% of the total, whichever number is the highest)</i></p> <p>The Auditor sampled [] people out of the total of [] people.</p>		

Ref	Procedures	Standard factual finding	Result (C / E / N.A.)
A.1	<p>PERSONNEL COSTS</p> <p><u>For the persons included in the sample and working under an employment contract or equivalent act (general procedures for individual actual personnel costs and personnel costs declared as unit costs)</u></p> <p>To confirm standard factual findings 1-5 listed in the next column, the Auditor reviewed following information/documents provided by the Beneficiary:</p> <ul style="list-style-type: none"> ○ a list of the persons included in the sample indicating the period(s) during which they worked for the action, their position (classification or category) and type of contract; ○ the payslips of the employees included in the sample; ○ reconciliation of the personnel costs declared in the Financial Statement(s) with the accounting system (project accounting and general ledger) and payroll system; ○ information concerning the employment status and employment conditions of personnel included in the sample, in particular their employment contracts or equivalent; ○ the Beneficiary's usual policy regarding payroll matters (e.g. salary policy, overtime policy, variable pay); ○ applicable national law on taxes, labour and social security and ○ any other document that supports the personnel costs declared. <p>The Auditor also verified the eligibility of all components of the retribution (see Article 6 GA) and recalculated the personnel costs for employees included in the sample.</p>	<p>1) The employees were i) directly hired by the Beneficiary in accordance with its national legislation, ii) under the Beneficiary's sole technical supervision and responsibility and iii) remunerated in accordance with the Beneficiary's usual practices.</p> <p>2) Personnel costs were recorded in the Beneficiary's accounts/payroll system.</p> <p>3) Costs were adequately supported and reconciled with the accounts and payroll records.</p> <p>4) Personnel costs did not contain any ineligible elements.</p> <p>5) There were no discrepancies between the personnel costs charged to the action and the costs recalculated by the Auditor.</p>	
	<p><i>Further procedures if 'additional remuneration' is paid</i></p> <p>To confirm standard factual findings 6-9 listed in the next column, the Auditor:</p> <ul style="list-style-type: none"> ○ reviewed relevant documents provided by the Beneficiary (legal form, legal/statutory 	<p>6) The Beneficiary paying "additional remuneration" was a non-profit legal entity.</p>	

Ref	Procedures	Standard factual finding	Result (C / E / N.A.)
	<p>obligations, the Beneficiary's usual policy on additional remuneration, criteria used for its calculation...);</p> <ul style="list-style-type: none"> ○ recalculated the amount of additional remuneration eligible for the action based on the supporting documents received (full-time or part-time work, exclusive or non-exclusive dedication to the action, etc.) to arrive at the applicable FTE/year and pro-rata rate (see data collected in the course of carrying out the procedures under A.2 'Productive hours' and A.4 'Time recording system'). <p><i>IF ANY PART OF THE REMUNERATION PAID TO THE EMPLOYEE IS NOT MANDATORY ACCORDING TO THE NATIONAL LAW OR THE EMPLOYMENT CONTRACT ("ADDITIONAL REMUNERATION") AND IS ELIGIBLE UNDER THE PROVISIONS OF ARTICLE 6.2.A.1, THIS CAN BE CHARGED AS ELIGIBLE COST TO THE ACTION UP TO THE FOLLOWING AMOUNT:</i></p> <p>(A) <i>IF THE PERSON WORKS FULL TIME AND EXCLUSIVELY ON THE ACTION DURING THE FULL YEAR: UP TO EUR 8 000/YEAR;</i></p> <p>(B) <i>IF THE PERSON WORKS EXCLUSIVELY ON THE ACTION BUT NOT FULL-TIME OR NOT FOR THE FULL YEAR: UP TO THE CORRESPONDING PRO-RATA AMOUNT OF EUR 8 000, OR</i></p> <p>(C) <i>IF THE PERSON DOES NOT WORK EXCLUSIVELY ON THE ACTION: UP TO A PRO-RATA AMOUNT CALCULATED IN ACCORDANCE TO ARTICLE 6.2.A.1.</i></p>	<p>7) The amount of additional remuneration paid corresponded to the Beneficiary's usual remuneration practices and was consistently paid whenever the same kind of work or expertise was required.</p> <p>8) The criteria used to calculate the additional remuneration were objective and generally applied by the Beneficiary regardless of the source of funding used.</p> <p>9) The amount of additional remuneration included in the personnel costs charged to the action was capped at EUR 8,000 per FTE/year (up to the equivalent pro-rata amount if the person did not work on the action full-time during the year or did not work exclusively on the action).</p>	
	<p><i>Additional procedures in case "unit costs calculated by the Beneficiary in accordance with its usual cost accounting practices" is applied:</i></p> <p>Apart from carrying out the procedures indicated above to confirm standard factual findings 1-5 and, if applicable, also 6-9, the Auditor carried out following procedures to confirm standard</p>	<p>10) The personnel costs included in the Financial Statement were calculated in accordance with the Beneficiary's usual cost accounting practice. This methodology was consistently</p>	

Ref	Procedures	Standard factual finding	Result (C / E / N.A.)
	<p>factual findings 10-13 listed in the next column:</p> <ul style="list-style-type: none"> ○ obtained a description of the Beneficiary's usual cost accounting practice to calculate unit costs; ○ reviewed whether the Beneficiary's usual cost accounting practice was applied for the Financial Statements subject of the present CFS; ○ verified the employees included in the sample were charged under the correct category (in accordance with the criteria used by the Beneficiary to establish personnel categories) by reviewing the contract/HR-record or analytical accounting records; ○ verified that there is no difference between the total amount of personnel costs used in calculating the cost per unit and the total amount of personnel costs recorded in the statutory accounts; ○ verified whether actual personnel costs were adjusted on the basis of budgeted or estimated elements and, if so, verified whether those elements used are actually relevant for the calculation, objective and supported by documents. 	<p>used in all H2020 actions.</p> <p>11) The employees were charged under the correct category.</p> <p>12) Total personnel costs used in calculating the unit costs were consistent with the expenses recorded in the statutory accounts.</p> <p>13) Any estimated or budgeted element used by the Beneficiary in its unit-cost calculation were relevant for calculating personnel costs and corresponded to objective and verifiable information.</p>	
	<p><u>For natural persons included in the sample and working with the Beneficiary under a direct contract other than an employment contract, such as consultants (no subcontractors).</u></p> <p>To confirm standard factual findings 14-18 listed in the next column the Auditor reviewed following information/documents provided by the Beneficiary:</p> <ul style="list-style-type: none"> ○ the contracts, especially the cost, contract duration, work description, place of work, ownership of the results and reporting obligations to the Beneficiary; ○ the employment conditions of staff in the same category to compare costs and; ○ any other document that supports the costs declared and its registration (e.g. invoices, 	<p>14) The natural persons reported to the Beneficiary (worked under the Beneficiary's instructions).</p> <p>15) They worked on the Beneficiary's premises (unless otherwise agreed with the Beneficiary).</p> <p>16) The results of work carried out belong to the Beneficiary.</p>	

Ref	Procedures	Standard factual finding	Result (C / E / N.A.)
	accounting records, etc.).	17) Their costs were not significantly different from those for staff who performed similar tasks under an employment contract with the Beneficiary.	
		18) The costs were supported by audit evidence and registered in the accounts.	
	<p><u>For personnel seconded by a third party and included in the sample (not subcontractors)</u></p> <p>To confirm standard factual findings 19-22 listed in the next column, the Auditor reviewed following information/documents provided by the Beneficiary:</p> <ul style="list-style-type: none"> ○ their secondment contract(s) notably regarding costs, duration, work description, place of work and ownership of the results; ○ if there is reimbursement by the Beneficiary to the third party for the resource made available (in-kind contribution against payment): any documentation that supports the costs declared (e.g. contract, invoice, bank payment, and proof of registration in its accounting/payroll, etc.) and reconciliation of the Financial Statement(s) with the accounting system (project accounting and general ledger) as well as any proof that the amount invoiced by the third party did not include any profit; ○ if there is no reimbursement by the Beneficiary to the third party for the resource made available (in-kind contribution free of charge): a proof of the actual cost borne by the Third Party for the resource made available free of charge to the Beneficiary such as a statement of costs incurred by the Third Party and proof of the registration in the Third Party's accounting/payroll; ○ any other document that supports the costs declared (e.g. invoices, etc.). 	19) Seconded personnel reported to the Beneficiary and worked on the Beneficiary's premises (unless otherwise agreed with the Beneficiary).	
		20) The results of work carried out belong to the Beneficiary.	
		<i>If personnel is seconded against payment:</i> 21) The costs declared were supported with documentation and recorded in the Beneficiary's accounts. The third party did not include any profit.	
		<i>If personnel is seconded free of charge:</i> 22) The costs declared did not exceed the third party's cost as	

Ref	Procedures	Standard factual finding	Result (C / E / N.A.)
		recorded in the accounts of the third party and were supported with documentation.	
A.2	<p>PRODUCTIVE HOURS</p> <p>To confirm standard factual findings 23-28 listed in the next column, the Auditor reviewed relevant documents, especially national legislation, labour agreements and contracts and time records of the persons included in the sample, to verify that:</p> <ul style="list-style-type: none"> ○ the annual productive hours applied were calculated in accordance with one of the methods described below, ○ the full-time equivalent (FTEs) ratios for employees not working full-time were correctly calculated. <p>If the Beneficiary applied method B, the auditor verified that the correctness in which the total number of hours worked was calculated and that the contracts specified the annual workable hours.</p> <p>If the Beneficiary applied method C, the auditor verified that the ‘annual productive hours’ applied when calculating the hourly rate were equivalent to at least 90 % of the ‘standard annual workable hours’. The Auditor can only do this if the calculation of the standard annual workable hours can be supported by records, such as national legislation, labour agreements, and contracts.</p> <p><i>BENEFICIARY'S PRODUCTIVE HOURS' FOR PERSONS WORKING FULL TIME SHALL BE ONE OF THE FOLLOWING METHODS:</i></p> <p><i>A. 1720 ANNUAL PRODUCTIVE HOURS (PRO-RATA FOR PERSONS NOT WORKING FULL-TIME)</i></p> <p><i>B. THE TOTAL NUMBER OF HOURS WORKED BY THE PERSON FOR THE BENEFICIARY IN THE YEAR (THIS METHOD IS ALSO REFERRED TO AS ‘TOTAL NUMBER OF HOURS WORKED’ IN THE NEXT COLUMN). THE CALCULATION OF THE TOTAL NUMBER OF HOURS WORKED WAS DONE AS</i></p>	<p>23) The Beneficiary applied method [<i>choose one option and delete the others</i>]</p> <p>[A: 1720 hours]</p> <p>[B: the ‘total number of hours worked’]</p> <p>[C: ‘annual productive hours’ used correspond to usual accounting practices]</p> <p>24) Productive hours were calculated annually.</p> <p>25) For employees not working full-time the full-time equivalent (FTE) ratio was correctly applied.</p> <p><i>If the Beneficiary applied method B.</i></p> <p>26) The calculation of the number of ‘annual workable hours’, overtime and absences was verifiable based on the documents provided by the Beneficiary.</p>	

Ref	Procedures	Standard factual finding	Result (C / E / N.A.)
	<p><i>FOLLOWS: ANNUAL WORKABLE HOURS OF THE PERSON ACCORDING TO THE EMPLOYMENT CONTRACT, APPLICABLE LABOUR AGREEMENT OR NATIONAL LAW PLUS OVERTIME WORKED MINUS ABSENCES (SUCH AS SICK LEAVE OR SPECIAL LEAVE).</i></p> <p><i>C. THE STANDARD NUMBER OF ANNUAL HOURS GENERALLY APPLIED BY THE BENEFICIARY FOR ITS PERSONNEL IN ACCORDANCE WITH ITS USUAL COST ACCOUNTING PRACTICES (THIS METHOD IS ALSO REFERRED TO AS ‘TOTAL ANNUAL PRODUCTIVE HOURS’ IN THE NEXT COLUMN). THIS NUMBER MUST BE AT LEAST 90% OF THE STANDARD ANNUAL WORKABLE HOURS.</i></p> <p><i>‘ANNUAL WORKABLE HOURS’ MEANS THE PERIOD DURING WHICH THE PERSONNEL MUST BE WORKING, AT THE EMPLOYER’S DISPOSAL AND CARRYING OUT HIS/HER ACTIVITY OR DUTIES UNDER THE EMPLOYMENT CONTRACT, APPLICABLE COLLECTIVE LABOUR AGREEMENT OR NATIONAL WORKING TIME LEGISLATION.</i></p>	<p><i>If the Beneficiary applied method C.</i></p> <p>27) The calculation of the number of ‘standard annual workable hours’ was verifiable based on the documents provided by the Beneficiary.</p> <p>28) The ‘annual productive hours’ used for calculating the hourly rate were consistent with the usual cost accounting practices of the Beneficiary and were equivalent to at least 90 % of the ‘annual workable hours’.</p>	
A.3	<p>HOURLY PERSONNEL RATES</p> <p><u>D) For unit costs calculated in accordance to the Beneficiary's usual cost accounting practice (unit costs):</u></p> <p>If the Beneficiary has a "Certificate on Methodology to calculate unit costs " (CoMUC) approved by the Commission, the Beneficiary provides the Auditor with a description of the approved methodology and the Commission’s letter of acceptance. The Auditor verified that the Beneficiary has indeed used the methodology approved. If so, no further verification is necessary.</p> <p>If the Beneficiary does not have a "Certificate on Methodology" (CoMUC) approved by the Commission, or if the methodology approved was not applied, then the Auditor:</p>	<p>29) The Beneficiary applied [choose one option and delete the other]:</p> <p>[Option I: “Unit costs (hourly rates) were calculated in accordance with the Beneficiary’s usual cost accounting practices”]</p> <p>[Option II: Individual hourly rates were applied]</p>	

Ref	Procedures	Standard factual finding	Result (C / E / N.A.)
	<ul style="list-style-type: none"> ○ reviewed the documentation provided by the Beneficiary, including manuals and internal guidelines that explain how to calculate hourly rates; ○ recalculated the unit costs (hourly rates) of staff included in the sample following the results of the procedures carried out in A.1 and A.2. <p><u>II) For individual hourly rates:</u></p> <p>The Auditor:</p> <ul style="list-style-type: none"> ○ reviewed the documentation provided by the Beneficiary, including manuals and internal guidelines that explain how to calculate hourly rates; ○ recalculated the hourly rates of staff included in the sample following the results of the procedures carried out in A.1 and A.2. <p><i>“UNIT COSTS CALCULATED BY THE BENEFICIARY IN ACCORDANCE WITH ITS USUAL COST ACCOUNTING PRACTICES”:</i> <i>IT IS CALCULATED BY DIVIDING THE TOTAL AMOUNT OF PERSONNEL COSTS OF THE CATEGORY TO WHICH THE EMPLOYEE BELONGS VERIFIED IN LINE WITH PROCEDURE A.1 BY THE NUMBER OF FTE AND THE ANNUAL TOTAL PRODUCTIVE HOURS OF THE SAME CATEGORY CALCULATED BY THE BENEFICIARY IN ACCORDANCE WITH PROCEDURE A.2.</i></p> <p><i>HOURLY RATE FOR INDIVIDUAL ACTUAL PERSONAL COSTS:</i> <i>IT IS CALCULATED BY DIVIDING THE TOTAL AMOUNT OF PERSONNEL COSTS OF AN EMPLOYEE VERIFIED IN LINE WITH PROCEDURE A.1 BY THE NUMBER OF ANNUAL PRODUCTIVE HOURS VERIFIED IN LINE WITH PROCEDURE A.2.</i></p>	<p><i>For option I concerning unit costs and if the Beneficiary applies the methodology approved by the Commission (CoMUC):</i></p> <p>30) The Beneficiary used the Commission-approved methodology to calculate hourly rates. It corresponded to the organisation's usual cost accounting practices and was applied consistently for all activities irrespective of the source of funding.</p> <p><i>For option I concerning unit costs and if the Beneficiary applies a methodology not approved by the Commission:</i></p> <p>31) The unit costs re-calculated by the Auditor were the same as the rates applied by the Beneficiary.</p> <p><i>For option II concerning individual hourly rates:</i></p> <p>32) The individual rates re-calculated by the Auditor were the same as the rates applied by the Beneficiary.</p>	

Ref	Procedures	Standard factual finding	Result (C / E / N.A.)
A.4	<p>TIME RECORDING SYSTEM</p> <p>To verify that the time recording system ensures the fulfilment of all minimum requirements and that the hours declared for the action were correct, accurate and properly authorised and supported by documentation, the Auditor made the following checks for the persons included in the sample that declare time as worked for the action on the basis of time records:</p> <ul style="list-style-type: none"> ○ description of the time recording system provided by the Beneficiary (registration, authorisation, processing in the HR-system); ○ its actual implementation; ○ time records were signed at least monthly by the employees (on paper or electronically) and authorised by the project manager or another manager; ○ the hours declared were worked within the project period; ○ there were no hours declared as worked for the action if HR-records showed absence due to holidays or sickness (further cross-checks with travels are carried out in B.1 below) ; ○ the hours charged to the action matched those in the time recording system. <p><i>ONLY THE HOURS WORKED ON THE ACTION CAN BE CHARGED. ALL WORKING TIME TO BE CHARGED SHOULD BE RECORDED THROUGHOUT THE DURATION OF THE PROJECT, ADEQUATELY SUPPORTED BY EVIDENCE OF THEIR REALITY AND RELIABILITY (SEE SPECIFIC PROVISIONS BELOW FOR PERSONS WORKING EXCLUSIVELY FOR THE ACTION WITHOUT TIME RECORDS).</i></p>	33) All persons recorded their time dedicated to the action on a daily/ weekly/ monthly basis using a paper/computer-based system. <i>(delete the answers that are not applicable)</i>	
		34) Their time-records were authorised at least monthly by the project manager or other superior.	
		35) Hours declared were worked within the project period and were consistent with the presences/absences recorded in HR-records.	
		36) There were no discrepancies between the number of hours charged to the action and the number of hours recorded.	
	<p><u>If the persons are working exclusively for the action and without time records</u></p> <p>For the persons selected that worked exclusively for the action without time records, the Auditor verified evidence available demonstrating that they were in reality exclusively dedicated to the action and that the Beneficiary signed a declaration confirming that they have worked exclusively for the action.</p>	37) The exclusive dedication is supported by a declaration signed by the Beneficiary's and by any other evidence gathered.	

Ref	Procedures	Standard factual finding	Result (C / E / N.A.)
B	COSTS OF SUBCONTRACTING		
B.1	<p>The Auditor obtained the detail/breakdown of subcontracting costs and sampled [redacted] cost items selected randomly (<i>full coverage is required if there are fewer than 10 items, otherwise the sample should have a minimum of 10 item, or 10% of the total, whichever number is highest</i>).</p> <p>To confirm standard factual findings 38-42 listed in the next column, the Auditor reviewed the following for the items included in the sample:</p> <ul style="list-style-type: none"> ○ the use of subcontractors was foreseen in Annex 1; ○ subcontracting costs were declared in the subcontracting category of the Financial Statement; ○ supporting documents on the selection and award procedure were followed; ○ the Beneficiary ensured best value for money (key elements to appreciate the respect of this principle are the award of the subcontract to the bid offering best price-quality ratio, under conditions of transparency and equal treatment. In case an existing framework contract was used the Beneficiary ensured it was established on the basis of the principle of best value for money under conditions of transparency and equal treatment). <p>In particular,</p> <ol style="list-style-type: none"> i. if the Beneficiary acted as a contracting authority within the meaning of Directive 2004/18/EC or of Directive 2004/17/EC, the Auditor verified that the applicable national law on public procurement was followed and that the subcontracting complied with the Terms and Conditions of the Agreement. ii. if the Beneficiary did not fall under the above-mentioned category the Auditor verified that the Beneficiary followed their usual procurement rules and respected the Terms and Conditions of the Agreement.. 	<p>38) The use of claimed subcontracting costs was foreseen in Annex I and costs were declared in the Financial Statements under the subcontracting category.</p> <p>39) There were documents of requests to different providers, different offers and assessment of the offers before selection of the provider in line with internal procedures and procurement rules. Subcontracts were awarded in accordance with the principle of best value for money.</p> <p><i>(When different offers were not collected the Auditor explains the reasons provided by the Beneficiary under the caption “Exceptions” of the Report. The JU will analyse this information to evaluate whether these costs might be accepted as eligible)</i></p> <p>40) The subcontracts were not awarded to other Beneficiaries</p>	

Ref	Procedures	Standard factual finding	Result (C / E / N.A.)
	<p>For the items included in the sample the Auditor also verified that:</p> <ul style="list-style-type: none"> ○ the subcontracts were not awarded to other Beneficiaries in the consortium; ○ there were signed agreements between the Beneficiary and the subcontractor; ○ there was evidence that the services were provided by subcontractor; 	<p>of the consortium.</p> <p>41) All subcontracts were supported by signed agreements between the Beneficiary and the subcontractor.</p> <p>42) There was evidence that the services were provided by the subcontractors.</p>	
C	COSTS OF PROVIDING FINANCIAL SUPPORT TO THIRD PARTIES		
C.1	<p>The Auditor obtained the detail/breakdown of the costs of providing financial support to third parties and sampled [redacted] cost items selected randomly (<i>full coverage is required if there are fewer than 10 items, otherwise the sample should have a minimum of 10 item, or 10% of the total, whichever number is highest</i>).</p> <p>The Auditor verified that the following minimum conditions were met:</p> <ul style="list-style-type: none"> a) the maximum amount of financial support for each third party did not exceed EUR 60 000, unless explicitly mentioned in Annex 1; b) the financial support to third parties was agreed in Annex 1 of the Agreement and the other provisions on financial support to third parties included in Annex 1 were respected. 	43) All minimum conditions were met	

D	OTHER ACTUAL DIRECT COSTS		
D.1	<p>COSTS OF TRAVEL AND RELATED SUBSISTENCE ALLOWANCES</p> <p>The Auditor sampled [] cost items selected randomly (<i>full coverage is required if there are fewer than 10 items, otherwise the sample should have a minimum of 10 item, or 10% of the total, whichever number is the highest</i>).</p> <p>The Auditor inspected the sample and verified that:</p> <ul style="list-style-type: none"> ○ travel and subsistence costs were consistent with the Beneficiary's usual policy for travel. In this context, the Beneficiary provided evidence of its normal policy for travel costs (e.g. use of first class tickets, reimbursement by the Beneficiary on the basis of actual costs, a lump sum or per diem) to enable the Auditor to compare the travel costs charged with this policy; ○ travel costs are correctly identified and allocated to the action (e.g. trips are directly linked to the action) by reviewing relevant supporting documents such as minutes of meetings, workshops or conferences, their registration in the correct project account, their consistency with time records or with the dates/duration of the workshop/conference; ○ no ineligible costs or excessive or reckless expenditure was declared. 	44) Costs were incurred, approved and reimbursed in line with the Beneficiary's usual policy for travels.	
		45) There was a link between the trip and the action.	
		46) The supporting documents were consistent with each other regarding subject of the trip, dates, duration and reconciled with time records and accounting.	
		47) No ineligible costs or excessive or reckless expenditure was declared.	
D.2	<p>DEPRECIATION COSTS FOR EQUIPMENT, INFRASTRUCTURE OR OTHER ASSETS</p> <p>The Auditor sampled [] cost items selected randomly (<i>full coverage is required if there are fewer than 10 items, otherwise the sample should have a minimum of 10 item, or 10% of the total, whichever number is the highest</i>).</p> <p>For “equipment, infrastructure or other assets” [from now on called “asset(s)”] selected in the sample the Auditor verified that:</p> <ul style="list-style-type: none"> ○ the assets were acquired in conformity with the Beneficiary's internal guidelines and procedures; ○ they were correctly allocated to the action (with supporting documents such as delivery 	48) Procurement rules, principles and guides were followed.	
		49) There was a link between the grant agreement and the asset charged to the action.	
		50) The asset charged to the action was traceable to the accounting records and the underlying documents.	

	<p>note invoice or any other proof demonstrating the link to the action)</p> <ul style="list-style-type: none"> ○ they were entered in the accounting system; ○ the extent to which the assets were used for the action (as a percentage) was supported by reliable documentation (e.g. usage overview table); <p>The Auditor recalculated the depreciation costs and verified that they were in line with the applicable rules in the Beneficiary's country and with the Beneficiary's usual accounting policy (e.g. depreciation calculated on the acquisition value).</p> <p>The Auditor verified that no ineligible costs such as deductible VAT, exchange rate losses, excessive or reckless expenditure were declared (see Article 6.5 GA).</p>	51) The depreciation method used to charge the asset to the action was in line with the applicable rules of the Beneficiary's country and the Beneficiary's usual accounting policy.	
		52) The amount charged corresponded to the actual usage for the action.	
		53) No ineligible costs or excessive or reckless expenditure were declared.	
D.3	<p>COSTS OF OTHER GOODS AND SERVICES</p> <p>The Auditor sampled [redacted] cost items selected randomly (<i>full coverage is required if there are fewer than 10 items, otherwise the sample should have a minimum of 10 item, or 10% of the total, whichever number is highest</i>).</p> <p>For the purchase of goods, works or services included in the sample the Auditor verified that:</p> <ul style="list-style-type: none"> ○ the contracts did not cover tasks described in Annex 1; ○ they were correctly identified, allocated to the proper action, entered in the accounting system (traceable to underlying documents such as purchase orders, invoices and accounting); ○ the goods were not placed in the inventory of durable equipment; ○ the costs charged to the action were accounted in line with the Beneficiary's usual accounting practices; ○ no ineligible costs or excessive or reckless expenditure were declared (see Article 6 GA). <p>In addition, the Auditor verified that these goods and services were acquired in conformity with the Beneficiary's internal guidelines and procedures, in particular:</p> <ul style="list-style-type: none"> ○ if Beneficiary acted as a contracting authority within the meaning of Directive 	54) Contracts for works or services did not cover tasks described in Annex 1.	
		55) Costs were allocated to the correct action and the goods were not placed in the inventory of durable equipment.	
		56) The costs were charged in line with the Beneficiary's accounting policy and were adequately supported.	
		57) No ineligible costs or excessive or reckless expenditure were declared. For internal invoices/charges only the cost element was charged, without any mark-ups.	

	<p>2004/18/EC or of Directive 2004/17/EC, the Auditor verified that the applicable national law on public procurement was followed and that the procurement contract complied with the Terms and Conditions of the Agreement.</p> <ul style="list-style-type: none"> ○ if the Beneficiary did not fall into the category above, the Auditor verified that the Beneficiary followed their usual procurement rules and respected the Terms and Conditions of the Agreement. <p>For the items included in the sample the Auditor also verified that:</p> <ul style="list-style-type: none"> ○ the Beneficiary ensured best value for money (key elements to appreciate the respect of this principle are the award of the contract to the bid offering best price-quality ratio, under conditions of transparency and equal treatment. In case an existing framework contract was used the Auditor also verified that the Beneficiary ensured it was established on the basis of the principle of best value for money under conditions of transparency and equal treatment); <p><i>SUCH GOODS AND SERVICES INCLUDE, FOR INSTANCE, CONSUMABLES AND SUPPLIES, DISSEMINATION (INCLUDING OPEN ACCESS), PROTECTION OF RESULTS, SPECIFIC EVALUATION OF THE ACTION IF IT IS REQUIRED BY THE AGREEMENT, CERTIFICATES ON THE FINANCIAL STATEMENTS IF THEY ARE REQUIRED BY THE AGREEMENT AND CERTIFICATES ON THE METHODOLOGY, TRANSLATIONS, REPRODUCTION.</i></p>	<p>58) Procurement rules, principles and guides were followed. There were documents of requests to different providers, different offers and assessment of the offers before selection of the provider in line with internal procedures and procurement rules. The purchases were made in accordance with the principle of best value for money.</p> <p><i>(When different offers were not collected the Auditor explains the reasons provided by the Beneficiary under the caption “Exceptions” of the Report. The JU will analyse this information to evaluate whether these costs might be accepted as eligible)</i></p>	
<p>D.4</p>	<p>AGGREGATED CAPITALISED AND OPERATING COSTS OF RESEARCH INFRASTRUCTURE</p> <p>The Auditor ensured the existence of a positive ex-ante assessment (issued by the EC Services) of the cost accounting methodology of the Beneficiary allowing it to apply the guidelines on direct costing for large research infrastructures in Horizon 2020.</p> <p><i>In the cases that a positive ex-ante assessment has been issued (see the standard factual findings 59-60 on the next column),</i></p>	<p>59) The costs declared as direct costs for Large Research Infrastructures (in the appropriate line of the Financial Statement) comply with the methodology described in the positive ex-ante assessment report.</p>	

	<p>The Auditor ensured that the beneficiary has applied consistently the methodology that is explained and approved in the positive ex ante assessment;</p> <p><i>In the cases that a positive ex-ante assessment has NOT been issued (see the standard factual findings 61 on the next column),</i></p> <p>The Auditor verified that no costs of Large Research Infrastructure have been charged as direct costs in any costs category;</p> <p><i>In the cases that a draft ex-ante assessment report has been issued with recommendation for further changes (see the standard factual findings 61 on the next column),</i></p> <ul style="list-style-type: none"> The Auditor followed the same procedure as above (when a positive ex-ante assessment has NOT yet been issued) and paid particular attention (testing reinforced) to the cost items for which the draft ex-ante assessment either rejected the inclusion as direct costs for Large Research Infrastructures or issued recommendations. 	60) Any difference between the methodology applied and the one positively assessed was extensively described and adjusted accordingly.	
		61) The direct costs declared were free from any indirect costs items related to the Large Research Infrastructure.	
E	USE OF EXCHANGE RATES		
E.1	<p>a) For Beneficiaries with accounts established in a currency other than euros</p> <p>The Auditor sampled [] cost items selected randomly and verified that the exchange rates used for converting other currencies into euros were in accordance with the following rules established in the Agreement (full coverage is required if there are fewer than 10 items, otherwise the sample should have a minimum of 10 item, or 10% of the total, whichever number is highest):</p> <p><i>COSTS INCURRED IN ANOTHER CURRENCY SHALL BE CONVERTED INTO EURO AT THE AVERAGE OF THE DAILY EXCHANGE RATES PUBLISHED IN THE C SERIES OF OFFICIAL JOURNAL OF THE EUROPEAN UNION (https://www.ecb.int/stats/exchange/eurofxref/html/index.en.html), DETERMINED OVER THE CORRESPONDING REPORTING PERIOD.</i></p> <p><i>IF NO DAILY EURO EXCHANGE RATE IS PUBLISHED IN THE OFFICIAL JOURNAL OF THE EUROPEAN UNION FOR THE CURRENCY IN QUESTION, CONVERSION SHALL BE MADE AT THE AVERAGE OF THE MONTHLY ACCOUNTING RATES ESTABLISHED BY THE COMMISSION AND PUBLISHED ON ITS WEBSITE (http://ec.europa.eu/budget/contracts_grants/info_contracts/inforeuro/inforeuro_en.cfm), DETERMINED OVER THE CORRESPONDING REPORTING PERIOD.</i></p>	62) The exchange rates used to convert other currencies into Euros were in accordance with the rules established of the Grant Agreement and there was no difference in the final figures.	

	<p>b) <u>For Beneficiaries with accounts established in euros</u></p> <p>The Auditor sampled [] cost items selected randomly and verified that the exchange rates used for converting other currencies into euros were in accordance with the following rules established in the Agreement (<i>full coverage is required if there are fewer than 10 items, otherwise the sample should have a minimum of 10 item, or 10% of the total, whichever number is highest</i>):</p> <p><i>COSTS INCURRED IN ANOTHER CURRENCY SHALL BE CONVERTED INTO EURO BY APPLYING THE BENEFICIARY'S USUAL ACCOUNTING PRACTICES.</i></p>	<p>63) The Beneficiary applied its usual accounting practices.</p>	
--	--	--	--

[legal name of the audit firm]

[name and function of an authorised representative]

[dd Month yyyy]

<Signature of the Auditor>

ANNEX 6

MODEL FOR THE CERTIFICATE ON THE METHODOLOGY

- For options [*in italics in square brackets*]: choose the applicable option. Options not chosen should be deleted.
- For fields in [grey in square brackets]: enter the appropriate data.

TABLE OF CONTENTS

TERMS OF REFERENCE FOR AN AUDIT ENGAGEMENT FOR A METHODOLOGY CERTIFICATE IN CONNECTION WITH ONE OR MORE GRANT AGREEMENTS FINANCED UNDER THE HORIZON 2020 RESEARCH AND INNOVATION FRAMEWORK PROGRAMME.....	2
INDEPENDENT REPORT OF FACTUAL FINDINGS ON THE METHODOLOGY CONCERNING GRANT AGREEMENTS FINANCED UNDER THE HORIZON 2020 RESEARCH AND INNOVATION FRAMEWORK PROGRAMME	5

Terms of reference for an audit engagement for a methodology certificate in connection with one or more grant agreements financed by [BBI][Clean Sky 2][ECSEL][FCH][IM2] JU under the Horizon 2020 Research and Innovation Framework Programme

This document sets out the ‘**Terms of Reference (ToR)**’ under which

[*OPTION 1: [insert name of the beneficiary] (‘the Beneficiary’) [OPTION 2: [insert name of the linked third party] (‘the Linked Third Party’), third party linked to the Beneficiary [insert name of the beneficiary] (‘the Beneficiary’)]*

agrees to engage

[insert legal name of the auditor] (‘the Auditor’)

to produce an independent report of factual findings (‘the Report’) concerning the [*Beneficiary’s*] [*Linked Third Party’s*] usual accounting practices for calculating and claiming direct personnel costs declared as unit costs (‘the Methodology’) in connection with grant agreements financed under the Horizon 2020 Research and Innovation Framework Programme.

The procedures to be carried out for the assessment of the methodology will be based on the grant agreement(s) detailed below:

[title and number of the grant agreement(s)] (‘the Agreement(s)’)

The Agreement(s) has(have) been concluded between the Beneficiary and the [Bio Based Industries][Clean Sky 2][ECSEL][Fuel Cells and Hydrogen 2][Innovative Medicines Initiative 2] Joint Undertaking (‘the JU’)

The JU is mentioned as a signatory of the Agreement with the Beneficiary only. The JU is not a party to this engagement.

1.1 Subject of the engagement

According to Article 18.1.2 of the Agreement, beneficiaries [*and linked third parties*] that declare direct personnel costs as unit costs calculated in accordance with their usual cost accounting practices may submit to the JU for approval by the Commission, a certificate on the methodology (‘CoMUC’) stating that there are adequate records and documentation to prove that their cost accounting practices used comply with the conditions set out in Point A of Article 6.2.

The subject of this engagement is the CoMUC which is composed of two separate documents:

- the Terms of Reference (‘the ToR’) to be signed by the [*Beneficiary*] [*Linked Third Party*] and the Auditor;
- the Auditor’s Independent Report of Factual Findings (‘the Report’) issued on the Auditor’s letterhead, dated, stamped and signed by the Auditor which includes; the standard statements (‘the Statements’) evaluated and signed by the [*Beneficiary*] [*Linked Third Party*], the agreed-upon procedures (‘the Procedures’) performed by the Auditor and the standard factual findings (‘the Findings’) assessed by the Auditor. The Statements, Procedures and Findings are summarised in the table that forms part of the Report.

The information provided through the Statements, the Procedures and the Findings will enable the Commission to draw conclusions regarding the existence of the [*Beneficiary’s*] [*Linked Third Party’s*] usual cost accounting practice and its suitability to ensure that direct personnel costs claimed on that

basis comply with the provisions of the Agreement. The Commission draws its own conclusions from the Report and any additional information it may require.

1.2 Responsibilities

The parties to this agreement are the *[Beneficiary]* *[Linked Third Party]* and the Auditor.

The *[Beneficiary]* *[Linked Third Party]*:

- is responsible for preparing financial statements for the Agreement(s) ('the Financial Statements') in compliance with those Agreements;
- is responsible for providing the Financial Statement(s) to the Auditor and enabling the Auditor to reconcile them with the *[Beneficiary's]* *[Linked Third Party's]* accounting and bookkeeping system and the underlying accounts and records. The Financial Statement(s) will be used as a basis for the procedures which the Auditor will carry out under this ToR;
- is responsible for its Methodology and liable for the accuracy of the Financial Statement(s);
- is responsible for endorsing or refuting the Statements indicated under the heading 'Statements to be made by the Beneficiary/ Linked Third Party' in the first column of the table that forms part of the Report;
- must provide the Auditor with a signed and dated representation letter;
- accepts that the ability of the Auditor to carry out the Procedures effectively depends upon the *[Beneficiary]* *[Linked Third Party]* providing full and free access to the *[Beneficiary's]* *[Linked Third Party's]* staff and to its accounting and other relevant records.

The Auditor:

- *[Option 1 by default: is qualified to carry out statutory audits of accounting documents in accordance with Directive 2006/43/EC of the European Parliament and of the Council of 17 May 2006 on statutory audits of annual accounts and consolidated accounts, amending Council Directives 78/660/EEC and 83/349/EEC and repealing Council Directive 84/253/EEC or similar national regulations].*
- *[Option 2 if the Beneficiary or Linked Third Party has an independent Public Officer: is a competent and independent Public Officer for which the relevant national authorities have established the legal capacity to audit the Beneficiary].*
- *[Option 3 if the Beneficiary or Linked Third Party is an international organisation: is an [internal] [external] auditor in accordance with the internal financial regulations and procedures of the international organisation].*

The Auditor:

- must be independent from the Beneficiary *[and the Linked Third Party]*, in particular, it must not have been involved in preparing the Beneficiary's *[and Linked Third Party's]* Financial Statement(s);
- must plan work so that the Procedures may be carried out and the Findings may be assessed;
- must adhere to the Procedures laid down and the compulsory report format;
- must carry out the engagement in accordance with these ToR;
- must document matters which are important to support the Report;
- must base its Report on the evidence gathered;
- must submit the Report to the *[Beneficiary]* *[Linked Third Party]*.

The Commission sets out the Procedures to be carried out and the Findings to be endorsed by the Auditor. The Auditor is not responsible for their suitability or pertinence. As this engagement is not an assurance engagement the Auditor does not provide an audit opinion or a statement of assurance.

1.3 Applicable Standards

The Auditor must comply with these Terms of Reference and with¹:

- the International Standard on Related Services ('ISRS') 4400 *Engagements to perform Agreed-upon Procedures regarding Financial Information* as issued by the International Auditing and Assurance Standards Board (IAASB);
- the *Code of Ethics for Professional Accountants* issued by the International Ethics Standards Board for Accountants (IESBA). Although ISRS 4400 states that independence is not a requirement for engagements to carry out agreed-upon procedures, the Commission requires that the Auditor also complies with the Code's independence requirements.

The Auditor's Report must state that there was no conflict of interests in establishing this Report between the Auditor and the Beneficiary *[and the Linked Third Party]* that could have a bearing on the Report, and must specify – if the service is invoiced - the total fee paid to the Auditor for providing the Report.

1.4 Reporting

The Report must be written in the language of the Agreement (see Article 20.7 of the Agreement).

Under Article 22 of the Agreement, the JU, the Commission, the European Anti-Fraud Office and the Court of Auditors have the right to audit any work that is carried out under the action and for which costs are claimed from the European Union budget. This includes work related to this engagement. The Auditor must provide access to all working papers related to this assignment if the JU, the Commission, the European Anti-Fraud Office or the European Court of Auditors requests them.

1.5 Timing

The Report must be provided by [dd Month yyyy].

1.6 Other Terms

[The [Beneficiary] [Linked Third Party] and the Auditor can use this section to agree other specific terms, such as the Auditor's fees, liability, applicable law, etc. Those specific terms must not contradict the terms specified above.]

[legal name of the Auditor]
[name & title of authorised representative]
[dd Month yyyy]
Signature of the Auditor

[legal name of the [Beneficiary] [Linked Third Party]]
[name & title of authorised representative]
[dd Month yyyy]
Signature of the [Beneficiary] [Linked Third Party]

¹ Supreme Audit Institutions applying INTOSAI-standards may carry out the Procedures according to the corresponding International Standards of Supreme Audit Institutions and code of ethics issued by INTOSAI instead of the International Standard on Related Services ('ISRS') 4400 and the Code of Ethics for Professional Accountants issued by the IAASB and the IESBA.

Independent report of factual findings on the methodology concerning grant agreements financed by the [BBI][Clean Sky 2][ECSEL][FCH][IMI2] JU under the Horizon 2020 Research and Innovation Framework Programme

(To be printed on letterhead paper of the auditor)

To

[name of contact person(s)], [Position]
[[Beneficiary's] [Linked Third Party's] name]
[Address]
[dd Month yyyy]

Dear [Name of contact person(s)],

As agreed under the terms of reference dated [dd Month yyyy]

with [OPTION 1: [insert name of the beneficiary] ('the Beneficiary')] [OPTION 2: [insert name of the linked third party] ('the Linked Third Party'), third party linked to the Beneficiary [insert name of the beneficiary] ('the Beneficiary')],

we

[name of the auditor] ('the Auditor'),

established at

[full address/city/state/province/country],

represented by

[name and function of an authorised representative],

have carried out the agreed-upon procedures ('the Procedures') and provide hereby our Independent Report of Factual Findings ('the Report'), concerning the [Beneficiary's] [Linked Third Party's] usual accounting practices for calculating and declaring direct personnel costs declared as unit costs ('the Methodology').

You requested certain procedures to be carried out in connection with the grant(s)

[title and number of the grant agreement(s)] ('the Agreement(s)').

The Report

Our engagement was carried out in accordance with the terms of reference ('the ToR') appended to this Report. The Report includes: the standard statements ('the Statements') made by the [Beneficiary] [Linked Third Party], the agreed-upon procedures ('the Procedures') carried out and the standard factual findings ('the Findings') confirmed by us.

The engagement involved carrying out the Procedures and assessing the Findings and the documentation requested appended to this Report, the results of which the Commission uses to draw conclusions regarding the acceptability of the Methodology applied by the [Beneficiary] [Linked Third Party].

The Report covers the methodology used from [dd Month yyyy]. In the event that the [Beneficiary] [Linked Third Party] changes this methodology, the Report will not be applicable to any Financial Statement² submitted thereafter.

The scope of the Procedures and the definition of the standard statements and findings were determined solely by the Commission. Therefore, the Auditor is not responsible for their suitability or pertinence.

Since the Procedures carried out constitute neither an audit nor a review made in accordance with International Standards on Auditing or International Standards on Review Engagements, we do not give a statement of assurance on the costs declared on the basis of the [Beneficiary's] [Linked Third Party's] Methodology. Had we carried out additional procedures or had we performed an audit or review in accordance with these standards, other matters might have come to its attention and would have been included in the Report.

Exceptions

Apart from the exceptions listed below, the [Beneficiary] [Linked Third Party] agreed with the standard Statements and provided the Auditor all the documentation and accounting information needed by the Auditor to carry out the requested Procedures and corroborate the standard Findings.

List here any exception and add any information on the cause and possible consequences of each exception, if known. If the exception is quantifiable, also indicate the corresponding amount.

.....

Explanation of possible exceptions in the form of examples (to be removed from the Report):

- i. the [Beneficiary] [Linked Third Party] did not agree with the standard Statement number ... because...;*
- ii. the Auditor could not carry out the procedure ... established because (e.g. due to the inability to reconcile key information or the unavailability or inconsistency of data);*
- iii. the Auditor could not confirm or corroborate the standard Finding number ... because*

Remarks

We would like to add the following remarks relevant for the proper understanding of the Methodology applied by the [Beneficiary] [Linked Third Party] or the results reported:

Example (to be removed from the Report):

Regarding the methodology applied to calculate hourly rates ...

Regarding standard Finding 15 it has to be noted that ...

The [Beneficiary] [Linked Third Party] explained the deviation from the benchmark statement XXIV concerning time recording for personnel with no exclusive dedication to the action in the following manner:

....

Annexes

Please provide the following documents to the auditor and annex them to the report when submitting this CoMUC to the JU:

1. Brief description of the methodology for calculating personnel costs, productive hours and hourly rates;

² Financial Statement in this context refers solely to Annex 4 of the Agreement by which the Beneficiary declares costs under the Agreement.

2. Brief description of the time recording system in place;
3. An example of the time records used by the [Beneficiary] [Linked Third Party];
4. Description of any budgeted or estimated elements applied, together with an explanation as to why they are relevant for calculating the personnel costs and how they are based on objective and verifiable information;
5. A summary sheet with the hourly rate for direct personnel declared by the [Beneficiary] [Linked Third Party] and recalculated by the Auditor for each staff member included in the sample (the names do not need to be reported);
6. A comparative table summarising for each person selected in the sample a) the time claimed by the [Beneficiary] [Linked Third Party] in the Financial Statement(s) and b) the time according to the time record verified by the Auditor;
7. A copy of the letter of representation provided to the Auditor.

Use of this Report

This Report has been drawn up solely for the purpose given under Point 1.1 Reasons for the engagement.

The Report:

- is confidential and is intended to be submitted to the JU by the [Beneficiary] [Linked Third Party] in connection with Article 18.1.2 of the Agreement;
- may not be used by the [Beneficiary] [Linked Third Party], by the JU or by the Commission for any other purpose, nor distributed to any other parties;
- may be disclosed by the JU or the Commission only to authorised parties, in particular the European Anti-Fraud Office (OLAF) and the European Court of Auditors.
- relates only to the usual cost accounting practices specified above and does not constitute a report on the Financial Statements of the [Beneficiary] [Linked Third Party].

No conflict of interest³ exists between the Auditor and the Beneficiary [and the Linked Third Party] that could have a bearing on the Report. The total fee paid to the Auditor for producing the Report was EUR [] (including EUR [] of deductible VAT).

We look forward to discussing our Report with you and would be pleased to provide any further information or assistance which may be required.

Yours sincerely

[legal name of the Auditor]
[name and title of the authorised representative]
[dd Month yyyy]
Signature of the Auditor

³ A conflict of interest arises when the Auditor's objectivity to establish the certificate is compromised in fact or in appearance when the Auditor for instance:

- was involved in the preparation of the Financial Statements;
- stands to benefit directly should the certificate be accepted;
- has a close relationship with any person representing the beneficiary;
- is a director, trustee or partner of the beneficiary; or
- is in any other situation that compromises his or her independence or ability to establish the certificate impartially.

Statements to be made by the Beneficiary/Linked Third Party ('the Statements') and Procedures to be carried out by the Auditor ('the Procedures') and standard factual findings ('the Findings') to be confirmed by the Auditor

The Commission reserves the right to provide the auditor with guidance regarding the Statements to be made, the Procedures to be carried out or the Findings to be ascertained and the way in which to present them. The Commission reserves the right to vary the Statements, Procedures or Findings by written notification to the Beneficiary/Linked Third Party to adapt the procedures to changes in the grant agreement(s) or to any other circumstances.

If this methodology certificate relates to the Linked Third Party's usual accounting practices for calculating and claiming direct personnel costs declared as unit costs any reference here below to 'the Beneficiary' is to be considered as a reference to 'the Linked Third Party'.

<i>Please explain any discrepancies in the body of the Report.</i>	
Statements to be made by Beneficiary	Procedures to be carried out and Findings to be confirmed by the Auditor
<p>A. Use of the Methodology</p> <p>I. The cost accounting practice described below has been in use since [dd Month yyyy].</p> <p>II. The next planned alteration to the methodology used by the Beneficiary will be from [dd Month yyyy].</p>	<p>Procedure:</p> <p>✓ The Auditor checked these dates against the documentation the Beneficiary has provided.</p> <p>Factual finding:</p> <p>1. The dates provided by the Beneficiary were consistent with the documentation.</p>
<p>B. Description of the Methodology</p> <p>III. The methodology to calculate unit costs is being used in a consistent manner and is reflected in the relevant procedures.</p> <p><i>[Please describe the methodology your entity uses to calculate <u>personnel costs</u>, productive hours and hourly rates, present your description to the Auditor and annex it to this certificate]</i></p> <p><i>[If the statement of section "B. Description of the methodology" cannot be endorsed by the Beneficiary or there is no written methodology to calculate unit costs it should be listed here below and reported as exception by the Auditor in the main Report of Factual Findings:</i> - ...]</p>	<p>Procedure:</p> <p>✓ The Auditor reviewed the description, the relevant manuals and/or internal guidance documents describing the methodology.</p> <p>Factual finding:</p> <p>2. The brief description was consistent with the relevant manuals, internal guidance and/or other documentary evidence the Auditor has reviewed.</p> <p>3. The methodology was generally applied by the Beneficiary as part of its usual costs accounting practices.</p>
<p>C. Personnel costs</p> <p><u>General</u></p>	<p>Procedure:</p> <p><i>The Auditor draws a sample of employees to carry out the procedures indicated in</i></p>

Please explain any discrepancies in the body of the Report.	
Statements to be made by Beneficiary	Procedures to be carried out and Findings to be confirmed by the Auditor
<p>IV. The unit costs (hourly rates) are limited to salaries including during parental leave, social security contributions, taxes and other costs included in the remuneration required under national law and the employment contract or equivalent appointing act;</p> <p>V. Employees are hired directly by the Beneficiary in accordance with national law, and work under its sole supervision and responsibility;</p> <p>VI. The Beneficiary remunerates its employees in accordance with its usual practices. This means that personnel costs are charged in line with the Beneficiary's usual payroll policy (e.g. salary policy, overtime policy, variable pay) and no special conditions exist for employees assigned to tasks relating to the European Union or Euratom, unless explicitly provided for in the grant agreement(s);</p> <p>VII. The Beneficiary allocates its employees to the relevant group/category/cost centre for the purpose of the unit cost calculation in line with the usual cost accounting practice;</p> <p>VIII. Personnel costs are based on the payroll system and accounting system.</p> <p>IX. Any exceptional adjustments of actual personnel costs resulted from relevant budgeted or estimated elements and were based on objective and verifiable information. <i>[Please describe the 'budgeted or estimated elements' and their relevance to personnel costs, and explain how they were reasonable and based on objective and verifiable information, present your explanation to the Auditor and annex it to this certificate].</i></p> <p>X. Personnel costs claimed do not contain any of the following ineligible costs: costs related to return on capital; debt and debt service charges; provisions for future losses or debts; interest owed; doubtful debts; currency exchange losses; bank costs charged by the Beneficiary's bank for transfers from the JU; excessive or reckless expenditure; deductible VAT or costs incurred during suspension of the implementation of the action.</p> <p>XI. Personnel costs were not declared under another EU or Euratom grant (including grants awarded by a Member State and financed by the EU budget and grants awarded by bodies other than the JU for the purpose of implementing the EU budget).</p> <p><u>If additional remuneration as referred to in the grant agreement(s) is paid</u></p>	<p><i>this section C and the following sections D to F.</i> <i>[The Auditor has drawn a random sample of 10 full-time equivalents made up of employees assigned to the action(s). If fewer than 10 full-time equivalents are assigned to the action(s), the Auditor has selected a sample of 10 full-time equivalents consisting of all employees assigned to the action(s), complemented by other employees irrespective of their assignments.]. For this sample:</i></p> <ul style="list-style-type: none"> ✓ the Auditor reviewed all documents relating to personnel costs such as employment contracts, payslips, payroll policy (e.g. salary policy, overtime policy, variable pay policy), accounting and payroll records, applicable national tax, labour and social security law and any other documents corroborating the personnel costs claimed; ✓ in particular, the Auditor reviewed the employment contracts of the employees in the sample to verify that: <ul style="list-style-type: none"> i. they were employed directly by the Beneficiary in accordance with applicable national legislation; ii. they were working under the sole technical supervision and responsibility of the latter; iii. they were remunerated in accordance with the Beneficiary's usual practices; iv. they were allocated to the correct group/category/cost centre for the purposes of calculating the unit cost in line with the Beneficiary's usual cost accounting practices; ✓ the Auditor verified that any ineligible items or any costs claimed under other costs categories or costs covered by other types of grant or by other grants financed from the European Union budget have not been taken into account when calculating the personnel costs; ✓ the Auditor numerically reconciled the total amount of personnel costs used to calculate the unit cost with the total amount of personnel costs recorded in the statutory accounts and the payroll system. ✓ to the extent that actual personnel costs were adjusted on the basis of budgeted or estimated elements, the Auditor carefully examined those elements and checked the information source to confirm that they correspond to objective and verifiable information;

<i>Please explain any discrepancies in the body of the Report.</i>	
Statements to be made by Beneficiary	Procedures to be carried out and Findings to be confirmed by the Auditor
<p>XII. The Beneficiary is a non-profit legal entity;</p> <p>XIII. The additional remuneration is part of the beneficiary's usual remuneration practices and paid consistently whenever the relevant work or expertise is required;</p> <p>XIV. The criteria used to calculate the additional remuneration are objective and generally applied regardless of the source of funding;</p> <p>XV. The additional remuneration included in the personnel costs used to calculate the hourly rates for the grant agreement(s) is capped at EUR 8 000 per full-time equivalent (reduced proportionately if the employee is not assigned exclusively to the action).</p> <p><i>[If certain statement(s) of section "C. Personnel costs" cannot be endorsed by the Beneficiary they should be listed here below and reported as exception by the Auditor in the main Report of Factual Findings: - ...]</i></p>	<p>✓ if additional remuneration has been claimed, the Auditor verified that the Beneficiary was a non-profit legal entity, that the amount was capped at EUR 8 000 per full-time equivalent and that it was reduced proportionately for employees not assigned exclusively to the action(s).</p> <p>✓ the Auditor recalculated the personnel costs for the employees in the sample.</p> <p>Factual finding:</p> <ol style="list-style-type: none"> 4. All the components of the remuneration that have been claimed as personnel costs are supported by underlying documentation. 5. The employees in the sample were employed directly by the Beneficiary in accordance with applicable national law and were working under its sole supervision and responsibility. 6. Their employment contracts were in line with the Beneficiary's usual policy; 7. Personnel costs were duly documented and consisted solely of salaries, social security contributions (pension contributions, health insurance, unemployment fund contributions, etc.), taxes and other statutory costs included in the remuneration (holiday pay, thirteenth month's pay, etc.); 8. The totals used to calculate the personnel unit costs are consistent with those registered in the payroll and accounting records; 9. To the extent that actual personnel costs were adjusted on the basis of budgeted or estimated elements, those elements were relevant for calculating the personnel costs and correspond to objective and verifiable information. The budgeted or estimated elements used are: — (indicate the elements and their values). 10. Personnel costs contained no ineligible elements; 11. Specific conditions for eligibility were fulfilled when additional remuneration was paid: a) the Beneficiary is registered in the grant agreements as a non-profit legal entity; b) it was paid according to objective criteria generally applied regardless of the source of funding used and c) remuneration was capped at EUR 8 000 per full-time equivalent (or up to up to the equivalent pro-rata amount if the person did not work on the

<i>Please explain any discrepancies in the body of the Report.</i>	
Statements to be made by Beneficiary	Procedures to be carried out and Findings to be confirmed by the Auditor
	action full-time during the year or did not work exclusively on the action).
<p>D. Productive hours</p> <p>XVI. The number of productive hours per full-time employee applied is <i>[delete as appropriate]</i>:</p> <p>A. 1720 productive hours per year for a person working full-time (corresponding pro-rata for persons not working full time).</p> <p>B. the total number of hours worked in the year by a person for the Beneficiary</p> <p>C. the standard number of annual hours generally applied by the beneficiary for its personnel in accordance with its usual cost accounting practices. This number must be at least 90% of the standard annual workable hours.</p> <p><u>If method B is applied</u></p> <p>XVII. The calculation of the total number of hours worked was done as follows: annual workable hours of the person according to the employment contract, applicable labour agreement or national law plus overtime worked minus absences (such as sick leave and special leave).</p> <p>XVIII. ‘Annual workable hours’ are hours during which the personnel must be working, at the employer’s disposal and carrying out his/her activity or duties under the employment contract, applicable collective labour agreement or national working time legislation.</p> <p>XIX. The contract (applicable collective labour agreement or national working time legislation) do specify the working time enabling to calculate the annual workable hours.</p> <p><u>If method C is applied</u></p> <p>XX. The standard number of productive hours per year is that of a full-time equivalent; for employees not assigned exclusively to the action(s) this number is reduced proportionately.</p> <p>XXI. The number of productive hours per year on which the hourly rate is based i) corresponds to the Beneficiary’s usual accounting practices; ii) is at least 90% of the standard number of workable (working) hours per year.</p>	<p>Procedure (same sample basis as for Section C: Personnel costs):</p> <ul style="list-style-type: none"> ✓ The Auditor verified that the number of productive hours applied is in accordance with method A, B or C. ✓ The Auditor checked that the number of productive hours per full-time employee is correct and that it is reduced proportionately for employees not exclusively assigned to the action(s). ✓ If method B is applied the Auditor verified i) the manner in which the total number of hours worked was done and ii) that the contract specified the annual workable hours by inspecting all the relevant documents, national legislation, labour agreements and contracts. ✓ If method C is applied the Auditor reviewed the manner in which the standard number of working hours per year has been calculated by inspecting all the relevant documents, national legislation, labour agreements and contracts and verified that the number of productive hours per year used for these calculations was at least 90% of the standard number of working hours per year. <p>Factual finding:</p> <p><u>General</u></p> <p>12. The Beneficiary applied a number of productive hours consistent with method A, B or C detailed in the left-hand column.</p> <p>13. The number of productive hours per year per full-time employee was accurate and was proportionately reduced for employees not working full-time or exclusively for the action.</p> <p><u>If method B is applied</u></p> <p>14. The number of ‘annual workable hours’, overtime and absences was verifiable based on the documents provided by the Beneficiary and the calculation of the total number of hours worked was accurate.</p> <p>15. The contract specified the working time enabling to calculate the annual workable hours.</p>

Please explain any discrepancies in the body of the Report.	
Statements to be made by Beneficiary	Procedures to be carried out and Findings to be confirmed by the Auditor
<p>XXII. Standard workable (working) hours are hours during which personnel are at the Beneficiary's disposal performing the duties described in the relevant employment contract, collective labour agreement or national labour legislation. The number of standard annual workable (working) hours that the Beneficiary claims is supported by labour contracts, national legislation and other documentary evidence.</p> <p><i>[If certain statement(s) of section "D. Productive hours" cannot be endorsed by the Beneficiary they should be listed here below and reported as exception by the Auditor: - ...]</i></p>	<p><u>If method C is applied</u></p> <p>16. The calculation of the number of productive hours per year corresponded to the usual costs accounting practice of the Beneficiary.</p> <p>17. The calculation of the standard number of workable (working) hours per year was corroborated by the documents presented by the Beneficiary.</p> <p>18. The number of productive hours per year used for the calculation of the hourly rate was at least 90% of the number of workable (working) hours per year.</p>
<p>E. Hourly rates</p> <p>The hourly rates are correct because:</p> <p>XXIII. Hourly rates are correctly calculated since they result from dividing annual personnel costs by the productive hours of a given year and group (e.g. staff category or department or cost centre depending on the methodology applied) and they are in line with the statements made in section C. and D. above.</p> <p><i>[If the statement of section 'E. Hourly rates' cannot be endorsed by the Beneficiary they should be listed here below and reported as exception by the Auditor: - ...]</i></p>	<p>Procedure</p> <ul style="list-style-type: none"> ✓ The Auditor has obtained a list of all personnel rates calculated by the Beneficiary in accordance with the methodology used. ✓ The Auditor has obtained a list of all the relevant employees, based on which the personnel rate(s) are calculated. <p>For 10 full-time equivalent employees selected at random (same sample basis as Section C: Personnel costs):</p> <ul style="list-style-type: none"> ✓ The Auditor recalculated the hourly rates. ✓ The Auditor verified that the methodology applied corresponds to the usual accounting practices of the organisation and is applied consistently for all activities of the organisation on the basis of objective criteria irrespective of the source of funding. <p>Factual finding:</p> <p>19. No differences arose from the recalculation of the hourly rate for the employees included in the sample.</p>
<p>F. Time recording</p> <p>XXIV. Time recording is in place for all persons with no exclusive dedication to one Horizon 2020 action. At least all hours worked in connection with the grant agreement(s) are registered on a daily/weekly/monthly basis <i>[delete as appropriate]</i> using a paper/computer-based system <i>[delete as appropriate]</i>;</p> <p>XXV. For persons exclusively assigned to one Horizon 2020 activity the Beneficiary has either signed a declaration to that effect or has put arrangements in place</p>	<p>Procedure</p> <ul style="list-style-type: none"> ✓ The Auditor reviewed the brief description, all relevant manuals and/or internal guidance describing the methodology used to record time. <p>The Auditor reviewed the time records of the random sample of 10 full-time equivalents referred to under Section C: Personnel costs, and verified in particular:</p>

<i>Please explain any discrepancies in the body of the Report.</i>	
Statements to be made by Beneficiary	Procedures to be carried out and Findings to be confirmed by the Auditor
<p>to record their working time;</p> <p>XXVI. Records of time worked have been signed by the person concerned (on paper or electronically) and approved by the action manager or line manager at least monthly;</p> <p>XXVII. Measures are in place to prevent staff from:</p> <ul style="list-style-type: none"> i. recording the same hours twice, ii. recording working hours during absence periods (e.g. holidays, sick leave), iii. recording more than the number of productive hours per year used to calculate the hourly rates, and iv. recording hours worked outside the action period. <p>XXVIII. No working time was recorded outside the action period;</p> <p>XXIX. No more hours were claimed than the productive hours used to calculate the hourly personnel rates.</p> <p><i>[Please provide a brief description of the <u>time recording system</u> in place together with the measures applied to ensure its reliability to the Auditor and annex it to the present certificate⁴].</i></p> <p><i>[If certain statement(s) of section “F. Time recording” cannot be endorsed by the Beneficiary they should be listed here below and reported as exception by the Auditor: - ...]</i></p>	<ul style="list-style-type: none"> ✓ that time records were available for all persons with not exclusive assignment to the action; ✓ that time records were available for persons working exclusively for a Horizon 2020 action, or, alternatively, that a declaration signed by the Beneficiary was available for them certifying that they were working exclusively for a Horizon 2020 action; ✓ that time records were signed and approved in due time and that all minimum requirements were fulfilled; ✓ that the persons worked for the action in the periods claimed; ✓ that no more hours were claimed than the productive hours used to calculate the hourly personnel rates; ✓ that internal controls were in place to prevent that time is recorded twice, during absences for holidays or sick leave; that more hours are claimed per person per year for Horizon 2020 actions than the number of productive hours per year used to calculate the hourly rates; that working time is recorded outside the action period; ✓ the Auditor cross-checked the information with human-resources records to verify consistency and to ensure that the internal controls have been effective. In addition, the Auditor has verified that no more hours were charged to Horizon 2020 actions per person per year than the number of productive hours per year used to calculate the hourly rates, and verified that no time worked outside the action period was charged to the action. <p>Factual finding:</p> <p>20. The brief description, manuals and/or internal guidance on time recording provided by the Beneficiary were consistent with management</p>

⁴ The description of the time recording system must state among others information on the content of the time records, its coverage (full or action time-recording, for all personnel or only for personnel involved in H2020 actions), its degree of detail (whether there is a reference to the particular tasks accomplished), its form, periodicity of the time registration and authorisation (paper or a computer-based system; on a daily, weekly or monthly basis; signed and countersigned by whom), controls applied to prevent double-charging of time or ensure consistency with HR-records such as absences and travels as well as its information flow up to its use for the preparation of the Financial Statements.

<i>Please explain any discrepancies in the body of the Report.</i>	
Statements to be made by Beneficiary	Procedures to be carried out and Findings to be confirmed by the Auditor
	<p>reports/records and other documents reviewed and were generally applied by the Beneficiary to produce the financial statements.</p> <p>21. For the random sample time was recorded or, in the case of employees working exclusively for the action, either a signed declaration or time records were available;</p> <p>22. For the random sample the time records were signed by the employee and the action manager/line manager, at least monthly.</p> <p>23. Working time claimed for the action occurred in the periods claimed;</p> <p>24. No more hours were claimed than the number productive hours used to calculate the hourly personnel rates;</p> <p>25. There is proof that the Beneficiary has checked that working time has not been claimed twice, that it is consistent with absence records and the number of productive hours per year, and that no working time has been claimed outside the action period.</p> <p>26. Working time claimed is consistent with that on record at the human-resources department.</p>
<i>[official name of the [Beneficiary] [Linked Third Party]]</i>	<i>[official name of the Auditor]</i>
<i>[name and title of authorised representative]</i>	<i>[name and title of authorised representative]</i>
<i>[dd Month yyyy]</i>	<i>[dd Month yyyy]</i>
<i><Signature of the [Beneficiary] [Linked Third Party]></i>	<i><Signature of the Auditor></i>

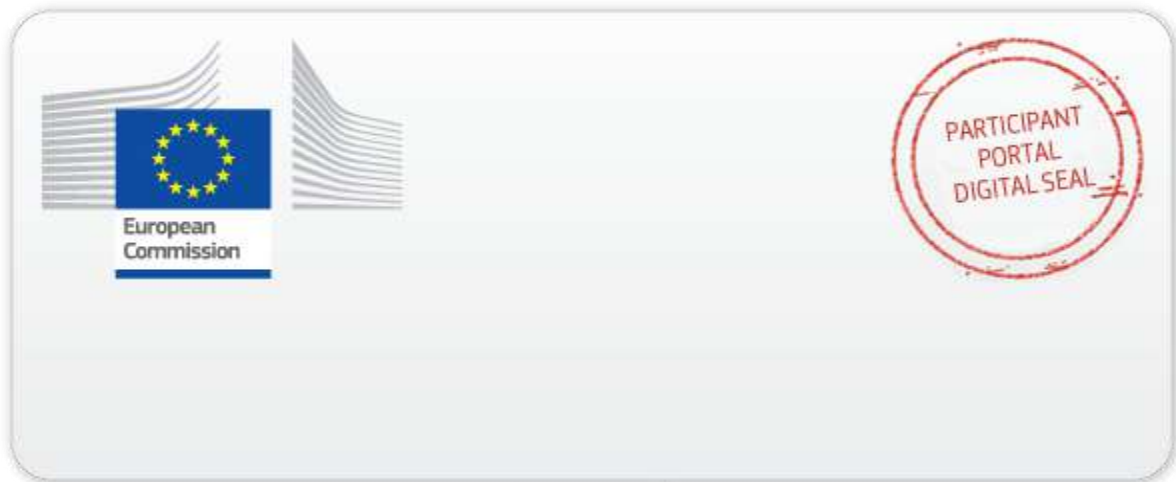

This document is digitally sealed. The digital sealing mechanism uniquely binds the document to the modules of the Participant Portal of the European Commission, to the transaction for which it was generated and ensures its integrity and authenticity.

Any attempt to modify the content will lead to a breach of the electronic seal, which can be verified at any time by clicking on the digital seal validation symbol.